



GES Canada Ltée
2345 Lapierre, LaSalle,
Quebec, Canada H8N 1B7

Tel.: 514.367.4848 / 1.877.399.3976
Fax: 514.367.5115
Email: montreal@ges.com



Exhibitions • Events • Experiences

ORDER FORMS

CANWELD EXPO
2017

September 13-14, 2017

Place Bonaventure

ges.com/ca



Dear Exhibitor,

We are pleased that GES Canada has been selected as your Official Service Contractor for:

CANWELD EXPO 2017

We strive to offer you the best possible service to facilitate a successful show experience. Please review this manual carefully, it contains information and order forms for each of the many services offered by GES Canada. In order to provide you with efficient service, it is most important that you return these forms to us promptly.

By placing your orders in advance, you can **have a valuable rebate** on most decorating items. Advance orders also make for a smoother more efficient move-in, avoiding unnecessary waits and showsite delivery delays as well as the possibility of selecting a sold out item.

To qualify for discount prices, orders must be received in our office on or before the deadline date on the order forms. Please be sure to reference each order form as deadline dates may vary. GES Canada requires payment in full at the time services are ordered. For your convenience, we require that you provide a credit card authorization with your initial order. This may be used to charge labour and material handling services not covered in your advance order. We accept Visa, Mastercard, American Express. **Please note that onsite pricing will include a premium.**

We realize that exhibiting in a tradeshow can be complicated. If you need assistance with your orders or additional information, please call our offices at 514.367.4848 from Monday to Friday from 8:30am until 4:30pm and ask to speak to a Customer Service Representative (CSR). In addition, our GES Service centre staff will be available throughout the show to assist you.

Thank you in advance for your valued business. We look forward to serving you and wish you a successful event

Save time, order online!

Place orders and manage your budget in one place.

**ORDER
NOW**

Sincerely,
Customer Service Team

GES Canada Ltd
2345 rue Lapierre
LaSalle, Québec H8N 1B7
Tél.: 514.367.4848
Toll Free : 1.877.399.3976
Fax.: 514.367.5115
montreal@ges.com



Show Information

CANWELD EXPO 2017

September 13-14, 2017

Place Bonaventure

Ordering online. To access our online forms, go to www.ges.com/ca.
Enter the city and click on "online ordering"

BOOTH EQUIPMENT

Your booth package 10'x10' includes:

8' high background and 3' high side dividers in black drape

One 8"x48" identification sign (black block text on white background)

Basic onsite materials handling to booth (up to 5,000 lbs/2200 kg per crate, except for specialty work)

Crate storage during the show

ELECTRICITY

Electricity is not included with the space. For all electrical needs please refer to the order form and return to GES.

EXHIBIT HALL CARPET

The exhibit hall IS NOT carpeted. **Floor covering is mandatory.**

PRICE DEADLINE DATE

In order to receive advance order discount rates, we must receive your order and payment by:

Monday, August 28, 2017

Regular price from:

Monday, September 11 2017

SHOW SCHEDULE

EXHIBITOR MOVE-IN

Tuesday, September 12 8 h - 22 h

Wednesday, September 13 8 h - 10 h

GES SERVICE DESK

Tuesday, September 12 8 h - 19 h

Wednesday, September 13 8 h - 11 h

EXHIBIT OPENING

Wednesday, September 13 10 h - 17 h

Thursday, September 14 10 h - 16 h

EXHIBITOR MOVE-OUT

Thursday, September 14 16 h 30 - 22 h

Friday, September 15 8 h - 14 h

SHIPPING AND MATERIAL HANDLING INFORMATION

Please review this section of the Exhibitor Kit thoroughly for: the proper shipping address to the facility, all information relating to advance freight, storage, and material handling of your goods during the move-in and move-out process.

OFFICIAL DECORATOR

GES Canada Ltd.

2345, Lapierre St.

Lasalle, Québec, H8N 1B7

T. 514.367.4848

F. 514.367.5115

OFFICIAL CARRIER (INTL.), CUSTOMS BROKER &

ADVANCE WAREHOUSE

BLP Global Show Logistics Inc

T. 902-703-0112

abennett@blplogistics.ca

miling@blplogistics.ca



Payment & Credit Card Charge Authorization

CANWELD EXPO 2017
 September 13-14, 2017
 Place Bonaventure

Billing Address

COMPANY NAME		BOOTH #	CONTACT NAME
STREET		PHONE	EMAIL
CITY	FAX	SHOW SITE CONTACT	
PROVINCE/STATE	POSTAL CODE	AND PHONE NUMBER	

Payment for Services - GES Canada Ltd. requires payment in full at the time services are ordered. Further, GES requires that you provide a credit card authorization with your initial order. For your convenience, we will use this authorization to charge your account for services, which may include labour and material handling, not covered by your initial payment. All applicable taxes will be added and charged to your credit card.
Discount Pricing - To qualify for discount pricing, orders must be received with payment on or before the discount price deadline.

Method of Payment - GES Canada Ltd. accepts American Express, Mastercard, Visa, cheque and wire transfers. Purchase orders are not considered payment. Exhibitors will be charged a fee for NSF cheques and for wire transfers (to cover the bank fees).

Third Party Billing - Each exhibiting firm is ultimately responsible for all charges incurred on it's behalf. GES Canada Ltd. reserves the right to institute collection action against the exhibitor if the authorized third party does not pay.

Tax Exempt - If you are tax exempted in Canada you must provide a GST and/or QST Exemption Certificate. Please send the above information to the GES Canada Ltd. office for this show. Taxes vary by location and will be added to your invoice if you do not submit your tax exemption certificate prior to the deadline.

Adjustments & Cancellations - It is the responsibility of the exhibitor to advise GES Canada Ltd. on-site representative(s) of any problem(s) with any of their orders. No adjustments will be made to invoices after the close of the show. All orders cancelled by the Exhibitor or due to the cancellation of an event or their non-participation may be subject to cancellation fees equal to 50% - 100% of the total order based upon the status of move-in, work performed, and/or Global Experience Specialists set up costs or expenses. Please refer to the individual forms for cancellation fees.

If you have any questions regarding our payment policy please call GES Canada Ltd. at 514.367.4848 or visit the GES Canada Ltd. Service Centre at the show.

Please complete the information and return payment in full with this form and your orders. You may choose to pay by credit card, cheque or wire transfer, however, we require your credit card charge authorization to be on file with GES Canada Ltd.

You agree to late fees of up to 1.5% per month on any balance not paid at the conclusion of the event or balance left without appropriate credit card on file.

For your convenience, we will use this authorization to charge your credit card for any additional amounts ordered by your representative or services rendered to your company for this event.

I agree in placing this order that I have accepted GES Canada Ltd. payment Policy and Terms & Conditions of Contract



AUTHORIZED SIGNATURE

Date:

AUTHORIZED NAME - PLEASE PRINT

Credit Card Charge Authorization Information to complete

Credit card number

Expiration date:

Security Code:

VISA

MasterCard

AMEX

Cardholder's Name

Cardholder Signature

FULL PAYMENT DUE

\$

Cheque payable to GES Canada Ltd. Your cheque must be received 2 weeks prior to move-in.

Enclosed is a cheque in the amount of:

\$

COMPANY NAME

BOOTH #

Merci de faire parvenir votre commande par / Please send your order by:

F. 514.367.5115 - montreal@ges.com

Service à la clientèle / Customer Service 514.367.4848 / 1.877. 399.3976



ELECTRONIC FUNDS/WIRE TRANSFER FORM

5675 McLaughlin Road, Mississauga, Ontario, L5R 3K5 Phone: 905-283-0500 Fax: 905-283-0501

Please complete and return this form to : Jolanta Baloniak, Accounts Receivable
GES Canada Limited
Email: ar@ges.com Fax: 905-283-0501

Your Company Name: _____
Contact Name: _____
Contact Number: _____
Booth Number: _____ Event Name: _____

GES BANK INFORMATION

PLEASE INCLUDE ALL OF THE FOLLOWING INFORMATION TO ENSURE YOUR FUNDS REACH OUR BANK

Beneficiary's Name: GES Canada Limited
Bank Name: Bank of Montreal
Address: 350 - 7th Avenue SW
Calgary, AB
T2P 3N9

IF YOU ARE SENDING
CANADIAN DOLLARS (\$CDN)



EFT/Direct Deposit

Institution code #: 001
Transit #: 00109
Account #: 1967-990

IF YOU ARE SENDING
AMERICAN DOLLARS (\$US)



Institution code #: 001
Transit #: 00109
Account #: 4773-410

Wire Transfers

Account #: 1967-990
Beneficiary's Bank: //CC000100109
Swift Code: BOFMCAM2

Account #: 4773-410
Beneficiary's Bank: //CC000100109
Intermediary bank: Wells Fargo Bank (FKA Wachovia)
Swift Code: PNBPU3NNYC

Routing / BIC / NCC / BSC or ABA Number: 026005092

Invoice Amount: _____ Date of Transfer: _____

*Minimum Bank Charge: \$20.00 (North American) \$40.00 (International)

Total: _____

Please Note: Please ensure transfer is made by the deadline date on your Order Form or Quotation.
Additional charges will be incurred for late payments, and services may be delayed.
*Minimum Bank Charges as shown above, reflect GES's bank charges only.
Any additional wire transfer and EFT fees are the exhibitor's responsibility.

CANWELD EXPO 2017
13-14 septembre 2017
Place Bonaventure

DATE BUTOIR PRIX ESCOMPTÉ / DEADLINE DISCOUNT PRICE
DATE BUTOIR PRIX RÉGULIER / DEADLINE REGULAR PRICE

28 août 2017 Aug 28, 2017
11 sept. 2017 Sept. 11, 2017

LISTE DE PRIX / PRICE LIST

Le service est disponible sur une base horaire à raison d'une heure minimum pour une équipe de 2 personnes.
The following services are available to exhibitors based on a minimum 2 men crew, for 1 hour minimum each.

		Régulier -lundi au vendredi 8:00 -17:00 <i>Regular - Monday to Friday 8 am to 5 pm</i>	Supplémentaire Après 17:00 et samedi / <i>Overtime After 5 pm and Saturday</i>	Taux double dimanche et jours fériés <i>Double time Sunday et legal holidays</i>	Instruction Spéciale <i>Special instruction</i>
VA-5200	Chariot & Opérateur/ forklift & operator: 5000 lbs/pounds et plus /and more	410 \$ / heure (hour)	N/A	N/A	

Commentaires additionnels pour le service de manutention - Machinerie Lourde Additional notes for Heavy Machinery Handling services

1) Le travail sera effectué avec des équipes de deux personnes au minimum, soit l'opérateur de chariot élévateur (dont le coût est inclus dans le prix) et un superviseur (Rigger/Millwright). Afin de maintenir un environnement de travail sécuritaire, une main-d'oeuvre additionnelle peut être nécessaire pour le travail requérant des équipements de levage de plus de 5,000lbs ainsi que pour des situations où plus d'un chariot est requis. La main-d'oeuvre additionnelle sera assignée à la discrétion de GES Canada Ltée, au taux de Rigger/Millwright.

All work will be performed with a minimum of two-men crew, consisting of a forklift operator (cost already included) and a Rigger/Millwright. To maintain a "Safety First" environment, heavy machinery handling requiring forklift in excess of 5,000 pounds, complex lifts and / or any handling requiring more than one forklift, will require additional manpower for a safe operation. Additional manpower will be assigned at the discretion of GES Canada Ltd, at the cost of Rigger / Millwright. *

2) Pour toute équipe, un minimum d'une heure sera facturé.

One hour minimum charge will be apply for any crews.

3) Les frais de manutention pour la sortie seront évalués à 80% des coûts de l'entrée de matériel. Ces frais sont payables au complet avant le début du démontage du salon. Tous les exposants doivent laisser les informations pertinentes pour que ces charges soient payées par carte de crédit.

Move-out costs will be calculated at 80% of the move-in costs and are due and payable in full, prior to Move-out. All exhibitors are required to have credit card information on file before any work will be

Les services de plus d'une heure seront facturés par tranches de 30 minutes par chariot élévateur.

Responsabilité limitée de GES Canada Ltée

● **Responsabilité** - GES Canada Ltée est responsable de pertes ou dommages causés à votre marchandise **UNIQUEMENT** si les dits dommages sont causés par une négligence de GES Canada Ltée..

● **Mesures de dédommagement** - Si GES Canada Ltée a été négligente et que cette négligence a causé la perte/dommage de votre matériel, les mesures de dédommagement seront déterminées ainsi:

a. Les mesures de dédommagement, dans quelconques circonstances (incluant le point b.) seront limitées au moindre coût entre la valeur dépréciée des biens ou le coût de réparation.

b. Le moindre coût entre: 0,30\$ par livre par morceau, 50,00\$ par morceau ou 1000,00\$ par circonstance.

GES Canada Ltée ne vend, ni offre des assurances. GES Canada Ltée n'est pas responsable si la perte ou le bris n'est pas causé par GES Canada Ltée.

GES Canada Ltd Limits of Liability

● **Liability** - GES Canada Ltd is liable for loss or damage to your goods ONLY if the loss or damage was caused by GES Canada Ltd negligence.

● **Measure of Damage** - If GES Canada Ltd was negligent and the negligence caused either loss or damage to your goods, then the measure of that damage will be determined by the following:

a. Measure of damages in all situations (including b. below) will be limited by the Depreciated Value of the goods or repair costs, whichever is less.

b. The lesser of \$0.30 per pound per piece, \$50 per piece, or \$1000 per occurrence.

Toutes les commandes sont soumises aux politiques de paiement et aux limites de responsabilité de GES Canada Ltée stipulées dans ce manuel de l'exposant. All orders are governed by the GES Canada Ltd. Payment Policy and Limits of Liability & Responsibility as specified in this Exhibitor Kit. INDEMNITÉ D'ANNULATION: Après le début du montage de salon, toute annulation sera facturée à 50% du coût original et à 100% après la livraison. CANCELLATION CLAUSE: Items cancelled after move-in begins will be charged at 50% of the original price and 100% after installation.	Montant / Amount	\$
	104060264 - TPS 5% GST	\$
	1001673382 - TVQ 9.975% QST	\$
	TOTAL	\$
	Compagnie / Company	STAND #



**MANUTENTION
POUR MACHINERIE LOURDE
HEAVY MACHINERY HANDLING**
(page 2)

**CANWELD EXPO 2017
13-14 septembre 2017
Place Bonaventure**

DATE BUTOIR PRIX ESCOMPTÉ / DEADLINE DISCOUNT PRICE
DATE BUTOIR PRIX RÉGULIER / DEADLINE REGULAR PRICE

28 août 2017 Aug 28, 2017

11 sept.2017 Sept.11, 2017

REGISTRE DES ÉQUIPMENTS LOURDS / HEAVY EQUIPMENT REGISTER

Type de Machinerie Machine Type	Poids Weight	Hauteur Height	Base		Caisson/Crated		Palette/Skidded		Pre- Rigged	Instructions spéciales Special Instructions	Date/hre arrivée (bureau seulement) Date/time in (office only)
			Long(pi) Length(ft)	Largeur(pi) Width(ft)	Oui Yes	Non No	Oui Yes	Non No			

Nom de Compagnie / Company name: _____
 Adresse / Address: _____
 Code postal / Postal code: _____
 Numéro de stand / Booth number: _____
 Contact / Contact: _____
 Téléphone / Phone: _____
 Télécopieur / Fax: _____

**S.V.P. ENVOYER CE FORMULAIRE PAR TÉLÉCOPIEUR AU 514.367.5115
PLEASE FAX COMPLETED FORM TO 514.367.5115**

Votre horaire d'entrée vous sera confirmé par GES Canada Ltée dès que nous aurons reçu le formulaire dûment complété. Conservez une copie pour vos dossiers.
 Move-In time will be allotted only when completed form is received at GES Canada Ltd. Retain a copy of completed forms for your records.

Notes: Toutes les commandes sont soumises aux politiques de paiement et aux limites de responsabilité de GES Canada Ltée stipulées dans ce manuel de l'exposant. All orders are governed by the GES Canada Ltd. Payment Policy and Limits of Liability & Responsibility as specified in this Exhibitor Kit. INDEMNITÉ D'ANNULATION: Après le début du montage de salon, toute annulation sera facturée à 50% du coût original et à 100% après la livraison. CANCELLATION CLAUSE: Items cancelled after move-in begins will be charged at 50% of the original price and 100% after installation.	Montant / Amount	\$
	104060264 - TPS 5% GST	\$
	1001673382 - TVQ 9.975% QST	\$
	TOTAL	\$
	Compagnie / Company	STAND #

Tél.:514-367-4848 / 1-877-399-3976 Courriel / Email: _____ Ne pas oublier de joindre le formulaire de paiement
 Do not forget to include the payment form



CANWELD EXPO 2017
13-14 septembre 2017
Place Bonaventure

COMPAGNIE / COMPANY	# STAND / BOOTH #

RENSEIGNEMENTS IMPORTANTS ET TARIFS / IMPORTANT INFORMATION AND RATES

TARIFS HORAIRES HOURLY RATES (Minimum 1hr)	HEURES / TIME	PAR OUVRIER / PER MAN
0595-IR Temps régulier Straight Time	Lundi au vendredi entre 08h00 et 16h00 Between 8:00AM and 4:00 PM Weekdays	90,00 \$
0595-IO Temps supplémentaire Overtime	Avant 08h00 et entre 16h00 et 18h00 du lundi au vendredi; Entre 08h00 et 16h00 le samedi et dimanche. / Before 8:00AM and between 4:00PM and 6:00PM Weekdays; Between 8:00AM and 4:00PM Saturdays and Sundays	134,00 \$
0595-ID Temps double Double time	Après 18h00 du lundi au vendredi; Après 16h00 le samedi et dimanche et lors de congés fériés. After 6:00PM Weekdays; After 4:00PM Saturdays and Sundays and on all holidays.	178,00 \$

VEUILLEZ COCHEZ VOTRE CHOIX / PLEASE CHECK YOUR CHOICE

GES CANADA SUPERVISE SANS LA PRÉSENCE DE L'EXPOSANT :

- Déballer et installer le matériel d'exposition avant l'arrivée de l'exposant
- Démonter et emballer le matériel à la fin du salon.

Une surcharge de 25% (Minimum 1 heure au taux en vigueur) de la facture de main-d'œuvre sera ajoutée pour ce dernier service additionnel.
Veillez cocher les cases appropriées

Photos - Directives ci-incluses : Dans la caisse ci-incluses

SUPERVISION EN PRÉSENCE DE L'EXPOSANT

- L'heure du début des travaux ne peut être garantie que lorsque la main-d'œuvre est réservée pour le début de la journée (à compter de 8h00).
- L'exposant doit se présenter au comptoir de services pour prendre en charge les ouvriers réservés et ainsi qu'une fois le travail complété.

GES Canada Ltée ne sera pas tenu responsable pour toute perte ou dommage causé durant l'installation, le déballage, le démontage ou l'emballage du matériel de l'exposant.

GES CANADA SUPERVISED THE INSTALLATION:

- Unpack and install display before exhibitor arrival at showsite.
- Dismantle and pack display after show closing.

25% (\$50.00 minimum) surcharge will be added to the labour rates above for the professional supervision.
Please check off the appropriate boxes:
Photos - Set-up instructions attached in crate attached

EXHIBITOR SUPERVISED (DO NOT PROCEED)

- Starting time can only be guaranteed where labourers are requested for the start of the working day, which is 8:00am.
- The exhibitor representative has to check in at the service desk to pick up labourers ordered. The exhibitor representative also has to check labourers out at the service desk upon completion of the work.

GES Canada Ltd. will not be responsible for any loss or damage arising from the installation, unpacking, dismantling or packing of exhibitor property.

À COMPLÉTER / TO BE COMPLETED

Minimum 1hr	# d'ouvrier # of labourers	Dates Dates	Heure début Start Time	Heure fin End Time	Total d'heures Total hours	Tarif Rate	Total
Installation / Set-Up							
Démontage / Dismantle							

LES POURBOIRES, INCLUANT ARGENT COMPTANT OU HEURES POUR TRAVAIL NON-EFFECTUÉS NE SONT PAS PERMIS PAR GES Spécialiste mondial de l'événement. GES Canada Ltée demande le plus haut niveau d'intégrité de tous ses employés.
GRATUITIES IN ANY FORM, INCLUDING CASH GIFTS, OR LABOUR HOURS FOR WORK NOT ACTUALLY PERFORMED ARE PROHIBITED BY GES Canada Ltd.. GES Canada Ltd requires the highest standards of integrity from all employees.

<p>Vous devez OBLIGATOIREMENT joindre le formulaire d'autorisation de carte de crédit à ce formulaire. Toutes les commandes sont soumises aux politiques de paiement et aux limites de responsabilités de GES Spécialiste mondial de l'événement stipulées dans ce catalogue de l'exposant. Frais d'annulation: Après le début du montage du salon, toute annulation sera facturée à 100% du coût original.</p> <p>The payment & credit card authorization form MUST accompany this form. All orders are governed by the GES Global Experience Specialists Payment Policy and Limits of Liability & Responsibility as specified in this Exhibitor Kit.</p> <p>Cancellation fees: Items cancelled after move-in begins will be charged at 100% of the original price.</p>	Montant / Amount	\$
	*Surcharge de 25 % / 25% surcharge	\$
	104060264 - TPS 5% GST	\$
	1001673382 - TVQ 9.975% QST	\$
	TOTAL	\$

Chaises / Chairs

0503



Chaise tissu gris
Side chair grey fabric

0504



Fauteuil tissu gris
Armchair grey fabric

0502-5



Fauteuil "Déco" noir
"Deco" armchair black

0502



Fauteuil aluminium
Aluminium armchair

Tabourets / Stools

0514-AL



Tabouret Alice
Alice Stool

0512



Tabouret de bar noir
Black bar stool

0514



Tabouret tissu gris
High stool grey fabric

Tables / Tables

0521



Table à café
Coffee table 30" x 18"H

0523



Table
Table 30" x 30"H

0527 A30



Table carrée aluminium
Square aluminium table 24" x 30"H

0527 A40



Table ronde aluminium
Round aluminium table 24" x 43"H

0553
0551



Table avec jupe
Draped table 72" x 24" x 30"H

Table avec jupe
Draped table 48" x 24" x 30"H

Disponible 42" haut / Available 42" high



Comptoirs, présentoirs, accessoires
Counters, showcases, accessories

Comptoirs, bureau / Counters, Desk

0651-CC-06



Comptoir courbé,
portes coulissantes
Curved counter with
sliding doors 40" x 20" x 40"H

0651-06



Comptoir, portes coulissantes
Counter with sliding doors 40" x 20" x 40"H

0650-06



Comptoir vitrine
Showcase counter 40" x 20" x 40"H

Présentoirs / Displays

0532



Chevalet
Tripod easel 61" H

0632-A



Porte affiche
Sign holder 60" H

0654-0



Présentoir vitrine ouvert
Open showcase 40" x 20" x 80"H

0621



Présentoir vitrine fermé
Close showcase 20" x 20" x 80"H

Divers / Miscellaneous

0608



Boîte de tirage pour table
Raffle cube for table 12" x 12" x 12"H

0661



Présentoirs
Display Units
Dimensions disponibles sur demande
Dimensions available upon request

0606-06



Boîte de tirage
Raffle Box 18.5" x 18.5" x 40"H

0532-A



Support à brochure
Literature rack 9" x 55"H

0532-B



Support à brochure accordéon
Zigzag Literature Rack

0500



Réfrigérateur compacte
Mini Fridge

CANWELD EXPO 2017

13-14 septembre 2017

Place Bonaventure

DATE BUTOIR PRIX ESCOMPTÉ / DEADLINE DISCOUNT PRICE: **28 août 2017 August 28**

DATE BUTOIR PRIX RÉGULIER / DEADLINE REGULAR PRICE: **11 septembre 2017 Sept. 11**

**Prix additionnel sur place /Extra Charge for onsite order*

LISTE DE PRIX / PRICE LIST

Qté/Qty	Code	Description	\$ Escompté Discount \$	\$ Régulier Regular \$	Total
Tables avec jupes Table / Skirted Tables (recouverte de vinyle blanc / White Vinyl Top)					
	0551	Table de 4' de long avec jupe 30" (h) / Skirted 4' long table with 30" high skirt	82,00 \$	119,00 \$	
	0553	Table de 6' de long avec jupe 30" (h) / Skirted 6' long table with 30" high skirt	92,00 \$	133,00 \$	
	0541	Table de 4' de long avec jupe 42" (h) / Skirted 4' long table with 42" high skirt	118,00 \$	171,00 \$	
	0542	Table de 6' de long avec jupe 42" (h) / Skirted 6' long table with 42" high skirt	134,00 \$	194,00 \$	
	0549	Jupe 4e côté (optionnel) / 4th side skirted (optional)	27,00 \$	39,00 \$	

Le blanc sera la couleur choisie par défaut si aucun choix n'a été fait. White will be provided if no other colour choice has been made.

Couleur de jupe/ Skirt color : Noir - Black Bleu - Blue Vert - Green Rouge - Red Blanc - White

Tables sans jupes (recouvert de vinyle seulement) / Un-skirted Tables (White Vinyl Top Only)

	0550	Table de 4' de longueur et 30" (h) / 4' long and 30" high table	45,00 \$	65,00 \$	
	0552	Table de 6' de longueur et 30" (h) / 6' long and 30" high table	50,00 \$	73,00 \$	
	0544	Table de 4' de longueur et 42" (h) / 4' long and 42" high table	77,00 \$	112,00 \$	
	0545	Table de 6' de longueur et 42" (h) / 6' long and 42" high table	84,00 \$	122,00 \$	

Tables

	0521	Table à café blanche 18" (h) / 18"H Round, White Coffee Table	68,00 \$	99,00 \$	
	0522	Table à café noire 18" (h) / 18"H Round, Black Coffee Table	68,00 \$	99,00 \$	
	0523	Table blanche 30"x30" (h) / 30"x30"H Round, White Table	92,00 \$	133,00 \$	
	0524	Table noire 30"x30" (h) / 30"x30"H Round, Black Table	92,00 \$	133,00 \$	
	0527-A-40	Table de cocktail 43" (h) / 43"H cocktail table	133,00 \$	193,00 \$	
	0527-A-30	Table carrée en aluminium 30" (h) / 30"H Aluminum square table	133,00 \$	193,00 \$	

Chaises / Chairs

	0502-A	Fauteuil aluminium / Aluminium Armchair	84,00 \$	122,00 \$	
	0502-5	Fauteuil déco noir / Black Deco Armchair	96,00 \$	139,00 \$	
	0503	Chaise de tissu gris (sans bras) / Grey Side Chair	67,00 \$	97,00 \$	
	0504	Fauteuil de tissu gris / Grey Arm Chair	81,00 \$	117,00 \$	
	0510	Chaise sténo / Steno Chair	70,00 \$	102,00 \$	
	0512	Tabouret de bar noir (sans dossier) / Black Bar Stool (no back)	45,00 \$	65,00 \$	
	0514	Tabouret de tissu gris (avec dos) / Grey Stool (with back)	81,00 \$	117,00 \$	
	0512-A	Tabouret Alice Noir / Black Alice Stool	109,00 \$	158,00 \$	

Comptoirs / Counters

	0651-06	Comptoir blanc avec portes 40" x 20" x 40"H White counter with doors	180,00 \$	261,00 \$	
	0651-CC-06	Comptoir courbé blanc 40" x 20.5" x 40"H White curved counter	294,00 \$	426,00 \$	
	0650-06	Comptoir vitrine 40" x 20" x 40"H Showcase counter	258,00 \$	374,00 \$	

Vous devez OBLIGATOIREMENT joindre le formulaire d'autorisation de carte de crédit à ce formulaire. Toutes les commandes sont soumises aux politiques de paiement et aux limites de responsabilités de GES Canada Ltée stipulées dans ce catalogue de l'exposant.
Frais d'annulation: Après le début du montage du salon, toute annulation sera facturée à 100% du coût original.

The payment & credit card authorization form MUST accompany this form. All orders are governed by the GES Canada Ltd. Payment Policy and Limits of Liability & Responsibility as specified in this Exhibitor Kit.

Cancellation fees: Items cancelled after move-in begins will be charged at 100% of the original price.

Montant / Amount \$

104060264 - TPS 5% GST \$

1001673382 - TVQ 9.975% QST \$

TOTAL \$

COMPAGNIE / COMPANY

STAND \ BOOTH #

Merci de faire parvenir votre commande par / Please send your order by: F. 514.367.5115 -- montreal@ges.com

Service à la clientèle / Customer Service 514.367.4848 / 1.877. 399.3976





CANWELD EXPO 2017
13-14 septembre 2017
Place Bonaventure

DATE BUTOIR PRIX ESCOMPTÉ / DEADLINE DISCOUNT PRICE:	28 août 2017 August 28, 2017
DATE BUTOIR PRIX RÉGULIER / DEADLINE REGULAR PRICE:	11 septembre 2017 Sept. 11

***Prix additionnel sur place /Extra Charge for onsite order**

***** Avant de commander votre tapis, assurez-vous que la salle n'est pas déjà recouverte de tapis *****
Before ordering a carpet, please verify that the room is not already carpeted

LISTE DE PRIX / PRICE LIST

Qté/Qty	Code	Description	\$ Escompté Discount \$	\$ Régulier Regular \$	Total		
Tapis standard / Standard Carpet							
	0576	10' x 10' Tapis standard / Standard Carpet	196,00 \$	284,00 \$			
	0577	10' x 20' Tapis standard / Standard Carpet	391,00 \$	567,00 \$			
	0579	10' x 30' Tapis standard / Standard Carpet	587,00 \$	851,00 \$			
Tapis grandeur spéciale / Custom-Cut Carpet							
Le tapis de grandeur spéciale est requis, sans exception, pour tout espace plus long que 30' ou pour tout espace en îlot ou en péninsule.							
Custom-cut carpet is required for all booths larger than 30', or for booths configured as an island or peninsula. No Exceptions.							
	0578	_____ ' X _____ ' = _____ Pi.Ca/ Sq. Ft.	2,90 \$	4,21 \$			
Sous-tapis / Underpadding							
	0564-B	Sous-tapis 10' x 10' Under Padding	125,00 \$	181,00 \$			
	0564-B	Sous-tapis 10' x 20' Under Padding	249,00 \$	361,00 \$			
	0564-B	Sous-tapis 10' x 30' Under Padding	374,00 \$	542,00 \$			
	0564-B	_____ ' X _____ ' = _____ Pi.Ca/ Sq. Ft.	1,65 \$	2,39 \$			
Recouvrement de plastique / Plastic Covering for Protection							
	0564-A0	_____ ' X _____ ' = _____ Pi.Ca/ Sq. Ft.	0,77 \$	1,12 \$			
Forfait Tapis (Inclut le tapis et le sous-tapis) / Carpet Package (Includes carpet and underpadding)							
	0570-AA	Forfait tapis 10' x 10' Carpet Package	259,00 \$	376,00 \$			
	0570-BA	Forfait tapis 10' x 20' Carpet Package	519,00 \$	753,00 \$			
	0570-CA	Forfait tapis 10' x 30' Carpet Package	779,00 \$	1 130,00 \$			
	570	_____ ' X _____ ' = _____ Pi.Ca/ Sq. Ft.	3,85 \$	5,58 \$			
Couleur de tapis / Colour Choice							
<input type="checkbox"/>		<input type="checkbox"/>		<input type="checkbox"/>		<input type="checkbox"/>	
Noir/Black		Bleu/Blue		Gris/Grey		Rouge/Red	
Le gris sera la couleur choisi par défaut si aucun choix n'a été fait. / Grey will be provided if no other color choice has been made.							
<p>Vous devez OBLIGATOIREMENT joindre le formulaire d'autorisation de carte de crédit à ce formulaire. Toutes les commandes sont soumises aux politiques de paiement et aux limites de responsabilités de GES Canada Ltée stipulées dans ce catalogue de l'exposant.</p> <p>Frais d'annulation: Après le début du montage du salon, toute annulation sera facturée à 100% du coût original.</p> <p>The payment & credit card authorization form MUST accompany this form. All orders are governed by the GES Canada Ltd. Payment Policy and Limits of Liability & Responsibility as specified in this Exhibitor Kit.</p> <p>Cancellation fees: Items cancelled after move-in begins will be charged at 100% of the original price.</p>			Montant / Amount		\$		
			104060264 - TPS 5% GST		\$		
			1001673382 - TVQ 9.975% QST		\$		
			TOTAL		\$		
			COMPAGNIE / COMPANY		STAND - BOOTH		

Merci de faire parvenir votre commande par / Please send your order by: F. 514.367.5115 - montreal@ges.com
 Service à la clientèle / Customer Service 514.367.4848 / 1.877.399.3976



CANWELD EXPO 2017
13-14 septembre 2017
 Place Bonaventure

DATE BUTOIR PRIX ESCOMPTÉ / DEADLINE DISCOUNT PRICE: **28 août 2017 August 28, 2017**

DATE BUTOIR PRIX RÉGULIER / DEADLINE REGULAR PRICE: **11 septembre 2017 Sept. 11**

**Prix additionnel sur place /Extra Charge for onsite order*

LISTE DE PRIX / PRICE LIST

Qté/Qty	Code	Description	\$ Escompté Discount \$	\$ Régulier Regular \$	Total
Accessoires divers / General Accessories					

	0532	Chevalet / Tripod Easel	46,00 \$	67,00 \$	
	0534	Corbeille à papier / Wastebasket	14,00 \$	20,00 \$	
	0534-B	Bac de recyclage / Recycling bin	14,00 \$	20,00 \$	
	0539	Porte manteaux en chrome / Chrome Garment Rack	60,00 \$	87,00 \$	
	0606	Boîte de tirage 20"x20"x40"H Raffle Box	123,00 \$	178,00 \$	
	0608	Boîte de tirage de table 12"x12"x12" / Raffle box on table	102,00 \$	148,00 \$	
	0621	Présentoir Vitrine 20" x 20" x 80"H Showcase	450,00 \$	653,00 \$	
	0632-A	Porte affiche 60"h / 60"H sign holder	56,00 \$	81,00 \$	
	0654-0	Présentoir (ouverte sur 4 côtés) 40" x 20" x 80" H Showcase (open on 4 sides)	617,00 \$	895,00 \$	
	0661-40H	Cube 18" x 18" x 40"H cube (plus d'options (couleurs, dimensions) disponibles / More options (colours, size) available)	125,00 \$	181,00 \$	
	0693-A	Panneau d'affichage 4'x8' / 4'x8' Poster Panel	116,00 \$	168,00 \$	
	0694	Support pour sac / Bag holder	77,00 \$	112,00 \$	
	0532-A	Présentoir à littérature / Literature Rack	116,00 \$	168,00 \$	
	0532-B	Présentoir littérature en Zig Zag	116,00 \$	168,00 \$	
	0500	Mini-réfrigérateur / Mini-frigo	233,00 \$	338,00 \$	

Vous devez OBLIGATOIREMENT joindre le formulaire d'autorisation de carte de crédit à ce formulaire. Toutes les commandes sont soumises aux politiques de paiement et aux limites de responsabilités de GES Canada Ltée stipulées dans ce catalogue de l'exposant.

Frais d'annulation: Après le début du montage du salon, toute annulation sera facturée à 100% du coût original.

The payment & credit card authorization form MUST accompany this form. All orders are governed by the GES Canada Ltd. Payment Policy and Limits of Liability & Responsibility as specified in this Exhibitor Kit.

Cancellation fees: Items cancelled after move-in begins will be charged at 100% of the original price.

Montant / Amount \$

104060264 - TPS 5% GST \$

1001673382 - TVQ 9.975% QST \$

TOTAL \$

COMPAGNIE / COMPANY

STAND BOOTH

Merci de faire parvenir votre commande par / Please send your order by: F. 514.367.5115 - montreal@ges.com
 Service à la clientèle / Customer Service 514.367.4848 / 1.877.399.3976



Panneaux & accessoires Panel & Accessories

Ajout à votre location de stand GES / Additional to GES booth rental

CANWELD EXPO 2017
13-14 septembre 2017
Place Bonaventure

DATE BUTOIR PRIX ESCOMPTÉ / DEADLINE DISCOUNT PRICE:	28 août 2017	August 28, 2017
DATE BUTOIR PRIX RÉGULIER / DEADLINE REGULAR PRICE:	11 septembre 2017	Sept. 11

***Prix additionnel sur place / Extra Charge for onsite order**

LISTE DE PRIX / PRICE LIST

Qté/Qty	Code	Description	\$ Escompté Discount \$	\$ Régulier Regular \$	Total
Accessoires / Accessories					
	0681	Tablette en mélamine / Melamine Shelf <input type="checkbox"/> Droite/Straight <input type="checkbox"/> Inclinée / Angled	45,00 \$	65,00 \$	
	0687-C	Rail vestimentaire / Barre d'accrochage 1M (Cintre non-inclus) 1M wide Garment Rail / Hanging Bar (Hangers not included)	62,00 \$	90,00 \$	
	0689	Cascade avec six crochets / Waterfall with six hooks	54,00 \$	78,00 \$	
	0282	Projecteur ajustable sur tige noire 75 watts / 75 watt Black Arm-Clamp Spotlight	55,00 \$	80,00 \$	

Panneaux / Panels

	1000	Panneau fibrex 38 1/8" x 91"(H) Fibrex Panel	141,00 \$	204,00 \$	
	1000	Panneau velcro 38 1/8" x 91" (H) Velcro Panel	141,00 \$	204,00 \$	
	1008	Panneau rainuré 38 1/8" x 91"(H) Slatwall Panel	164,00 \$	238,00 \$	
	1009	Panneau perforé blanc 38 1/8" x 85"(H) White pegboard Panel	143,00 \$	207,00 \$	

Vous devez OBLIGATOIREMENT joindre le formulaire d'autorisation de carte de crédit à ce formulaire. Toutes les commandes sont soumises aux politiques de paiement et aux limites de responsabilités de GES Canada Ltée stipulées dans ce catalogue de l'exposant.

Frais d'annulation: Après le début du montage du salon, toute annulation sera facturée à 100% du coût original.

The payment & credit card authorization form MUST accompany this form. All orders are governed by the GES Canada Ltd Payment Policy and Limits of Liability & Responsibility as specified in this Exhibitor Kit.

Cancellation fees: Items cancelled after move-in begins will be charged at 100% of the original price.

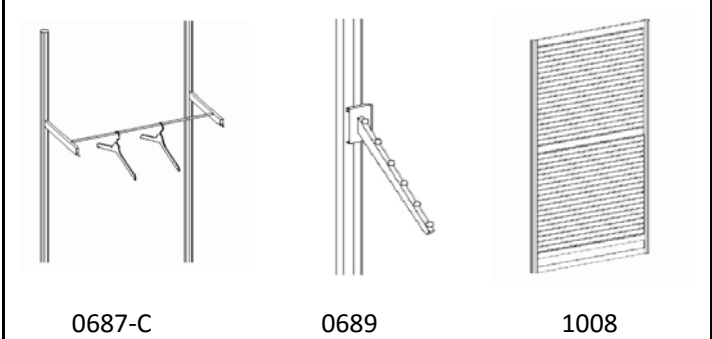

0687-C	0689	1008	
Montant / Amount			\$
104060264 - TPS 5% GST			\$
1001673382 - TVQ 9.975% QST			\$
TOTAL			\$
COMPAGNIE / COMPANY			STAND #



Tentures Drapes

CANWELD EXPO 2017
13-14 septembre 2017
Place Bonaventure

DATE BUTOIR PRIX ESCOMPTÉ / DEADLINE DISCOUNT PRICE:	28 août 2017	August 28, 2017
DATE BUTOIR PRIX RÉGULIER / DEADLINE REGULAR PRICE:	11 septembre 2017	Sept. 11

***Prix additionnel sur place /Extra Charge for onsite order**

LISTE DE PRIX / PRICE LIST

Qté/Qty	Code	Description	\$ Escompté Discount \$	\$ Régulier Regular \$	Total
Les prix incluent la location, la livraison, l'installation et le démontage / Prices include rental, delivery, installation and dismantle					
Tentures / Drapes					
	0590	tenture 8' haut (pi.lin.) incluant métal / Drapes 8' high (lin.ft) metal incl.	8,00 \$	12,00 \$	
	0591	tenture 3' haut (pi.lin.) incluant métal / Drapes 3' high (lin.ft) Metal incl.	6,00 \$	9,00 \$	
<i>Tentures de couleur: noir <input type="checkbox"/> bleu <input type="checkbox"/> rouge <input type="checkbox"/> blanc <input type="checkbox"/></i> <i>Drapes color: black <input type="checkbox"/> blue <input type="checkbox"/> red <input type="checkbox"/> white <input type="checkbox"/></i>					
Poteaux, Bases / Posts and Bases					
	0588-E	Poteau et Base de 3 pieds / Post and Base 3 ft.	37,00 \$	54,00 \$	
	0588-F	Poteau et Base de 8 pieds / Post and Base 8 ft.	37,00 \$	54,00 \$	
	0588-G	Poteau et Base de 10 pieds / Post and Base 10 ft.	37,00 \$	54,00 \$	
Tringles / Sliders					
	0588-04	Tringle de 4 pieds / Slider 4 ft.	29,00 \$	42,00 \$	
	0588-06	Tringle de 6 pieds / Slider 6 ft.	32,00 \$	46,00 \$	
	0588-08	Tringle de 8 pieds / Slider 8 ft.	36,00 \$	52,00 \$	
	0588-10	Tringle de 10 pieds / Slider 10 ft.	38,00 \$	55,00 \$	
<p>Vous devez OBLIGATOIREMENT joindre le formulaire d'autorisation de carte de crédit à ce formulaire. Toutes les commandes sont soumises aux politiques de paiement et aux limites de responsabilités de GES Canada Ltée stipulées dans ce catalogue de l'exposant. Frais d'annulation: Après le début du montage du salon, toute annulation sera facturée à 100% du coût original.</p> <p>The payment & credit card authorization form MUST accompany this form. All orders are governed by the GES Canada Ltd. Payment Policy and Limits of Liability & Responsibility as specified in this Exhibitor Kit.</p> <p>Cancellation fees: Items cancelled after move-in begins will be charged at 100% of the original price.</p>			Montant / Amount		\$
			104060264 - TPS 5% GST		\$
			1001673382 - TVQ 9.975% QST		\$
			TOTAL		\$
			COMPAGNIE / COMPANY		STAND #

Merci de faire parvenir votre commande par / Please send your order by: F. 514.367.5115 - montreal@ges.com
Service à la clientèle / Customer Service 514.367.4848 / 1.877. 399.3976



Ameublement distinctif Specialty Furniture

DISPONIBILITÉ SELON L'INVENTAIRE . PRIX POUR 1 À 7 JOURS DE LOCATION
AVAILABLE UPON INVENTORY . PRICES FOR 1 TO 7 DAYS OF RENTAL

DATE BUTOIR PRIX ESCOMPTÉ /
DISCOUNT PRICE DEADLINE : August 28, 2017

DATE BUTOIR PRIX RÉGULIER /
REGULAR PRICE DEADLINE : September 11, 2017

LA COMMANDE D'AMEUBLEMENT DISTINCTIF N'EST PAS DISPONIBLE SUR SITE.
SPECIALTY FURNITURE ORDERING IS NOT AVAILABLE ON-SITE.

Fauteuils Armchairs



DX101

Fidji (Centre)
36"L x 28"l x 27"H

Gris, Blanc, Noir, Rouge
Grey, White, Black, Red



DX102

Fidji (Coin / Corner)
36"L x 36"l x 27"H

Gris, Blanc, Noir
Grey, White, Black



DX103

Malibu
39"L x 39"l x 39"H

Charbon, Gris, Bleu, Rouge
Charcoal, Grey, Blue, Red



DX104

Strip (Coin / Corner)
30"L x 30"l x 26"H

Blanc, Noir
White, Black



DX105

Strip (Centre)
30"L x 30"l x 26"H

Blanc, Noir
White, Black



DX106

Vogue (Plein / Complete)
57"L x 32"l x 28"H

Blanc, Noir
White, Black



DX107

Scarpino
32"L x 30"l x 31"H

Blanc, Noir
White, Black



DX108

Smoking
27"L x 31"l x 27"H

Blanc, Noir
White, Black



DX109

Madmen Solo
36"L x 32"l x 30"H

Blanc, Noir
White, Black



DX110

Roméo
33"L x 33"l x 45"H

Noir
Black



DX112

Apollo
39"L x 22"l x 48"H

Blanc
White



DX113

Juliette
27"L x 23"l x 34"H

Blanc
White



Canapés Sofas



DX201

Malibu / Trio
78"L x 39"l x 39"H

Charbon, Gris, Bleu, Rouge
Charcoal, Grey, Blue, Red



DX202

Strip / Duo
60"L x 30"l x 26"H

Blanc, Noir
White, Black



DX204

Strip / Trio
90"L x 30"l x 26"H

Blanc, Noir
White, Black



DX206

Vogue (Demi / Partial)
57"L x 32"l x 16"H

Blanc, Noir
White, Black



DX208

Madmen / Duo
60"L x 32"l x 30"H

Blanc, Noir
White, Black



DX209

Madmen / Trio
83"L x 32"l x 30"H

Blanc, Noir
White, Black

Les couleurs peuvent varier en fonction de l'éclairage, les limites d'impression et les différences de teinture en lot. / Colors may vary due to facility lighting, printing limitations and dye lot differences.

Merci de faire parvenir votre commande par / Please send your order by | F. 514.367.5115 | montreal@ges.com
Service à la clientèle / Customer service | T. 514.367.4848 | 1.877.399.3976



Ameublement distinctif Specialty Furniture

DISPONIBILITÉ SELON L'INVENTAIRE . PRIX POUR 1 À 7 JOURS DE LOCATION
AVAILABLE UPON INVENTORY . PRICES FOR 1 TO 7 DAYS OF RENTAL

DATE BUTOIR PRIX ESCOMPTÉ /
DISCOUNT PRICE DEADLINE : August 28, 2017

DATE BUTOIR PRIX RÉGULIER /
REGULAR PRICE DEADLINE : September 11, 2017

LA COMMANDE D'AMEUBLEMENT DISTINCTIF N'EST PAS DISPONIBLE SUR SITE.
SPECIALTY FURNITURE ORDERING IS NOT AVAILABLE ON-SITE.

Ottomans Ottomans



DX301

Fidji
36"L x 36"l x 16"H
■ ■ ■
Gris, Blanc, Noir
Grey, White, Black



DX302

Fidji (Banc / Bench)
72"L x 18"l x 16"H
□
Blanc
White



DX303

Malibu / Cube
20"L x 20"l x 16"H
■ ■ ■ ■ ■
Charbon, Gris, Bleu, Rouge
Charcoal, Grey, Blue, Red



DX304

Malibu / Rectangle
27.5"L x 20"l x 16"H
■ ■ ■ ■ ■
Charbon, Gris, Bleu, Rouge
Charcoal, Grey, Blue, Red



DX305

Strip
30"L x 30"l x 16"H
□ ■
Blanc, Noir
White, Black



DX306

Vogue
57"L x 32"l x 28"H
□ ■
Blanc, Noir
White, Black



DX307

Vogue (Pouf / Round)
32"Ø x 16"H
□ ■
Blanc, Noir
White, Black

Chaises Chairs



DX401

Milan
17"L x 19"l x 35.5"H
■ ■ ■ ■ ■
Gris, Blanc, Noir, Rouge
Grey, White, Black, Red



DX402

Président
24.5"L x 23"l x 40.5-43.5"H
■
Noir
Black

Tabourets Barstools



DX501

Sprint
15"L x 13.5"l x 36"H
□
Blanc
White



DX502

Broadway
16.5"L x 21"l x 39.5"H
□ ■
Blanc, Noir
White, Black



DX503

Cosmo
17.5"L x 11"l x 26.5"- 34"
□ ■
Blanc, Noir
White, Black



DX504

Loft
17"L x 17"l x 30"H
■ ■
Métal Argent, Noir
Silver, Black metal



DX505

Loft + dossier / backrest
17"L x 17"l x 37.5"H
■ ■
Métal Gris, Blanc
Grey, White metal

Les couleurs peuvent varier en fonction de l'éclairage, les limites d'impression et les différences de teinture en lot. / Colors may vary due to facility lighting, printing limitations and dye lot differences.

Merci de faire parvenir votre commande par / Please send your order by | F. 514.367.5115 | montreal@ges.com
Service à la clientèle / Customer service | T. 514.367.4848 | 1.877.399.3976



Ameublement distinctif Specialty Furniture

DISPONIBILITÉ SELON L'INVENTAIRE • PRIX POUR 1 À 7 JOURS DE LOCATION
AVAILABLE UPON INVENTORY • PRICES FOR 1 TO 7 DAYS OF RENTAL

DATE BUTOIR PRIX ESCOMPTE / August 28, 2017
DISCOUNT PRICE DEADLINE:

DATE BUTOIR PRIX RÉGULIER / September 11, 2017
REGULAR PRICE DEADLINE:

LA COMMANDE D'AMEUBLEMENT DISTINCTIF N'EST PAS DISPONIBLE SUR SITE.
SPECIALTY FURNITURE ORDERING IS NOT AVAILABLE ON-SITE.

Tables Cocktail Cruiser tables



DX601

Tonic
24"L x 24" x 40"H

Argent brillant, Blanc, Noir, Rouge
Shiny silver, White, Black, Red



DX602

Tonic (Commune / Communal)
72"L x 24" x 40"H

Blanc, Noir
White, Black



DX603

Tonic (Console)
72"L x 18" x 40"H

Blanc, Noir
White, Black



DX604

Cosmo
24"D x 40"H

Blanc, Noir, Rouge
White, Black, Red

Tables Tables



DX701

Table dîner 4'x30" / Dinner table
48"L x 42" x 30"H

Blanc
White



DX702

Table dîner 4'x40" / Dinner table
48"L x 42" x 40"H

Blanc
White



DX703

Table dîner 8'x30" / Dinner table
96"L x 42" x 30"H

Blanc
White



DX704

Table dîner 8'x40" / Dinner table
96"L x 42" x 40"H

Blanc
White



DX705

Mezzo (Café / Coffee)
30"L x 30" x 16"H

Argent brillant, Blanc, Noir, Inox
Shiny silver, White, Black, Stainless



DX706

Piccolo (Appoint / Occasional)
16"L x 16" x 16"H

Blanc, Noir, Miroir
White, Black, Mirror



DX707

French Kiss
47"L x 27" x 17.5"H

Blanc, Noir, Rouge
White, Black, Red



DX708

Kimono
36"L x 36" x 17.5"H

Blanc, Noir, Rouge
White, Black, Red



DX709

O
43.5"L x 24" x 16"H

Argent, Blanc, Noir
Silver, White, Black



DX714

Table en U ou Coin sur ottoman Fidji
Ottoman Fidji U shaped or Corner table

Blanc
White

Les couleurs peuvent varier en fonction de l'éclairage, les limites d'impression et les différences de teinture en lot. / Colors may vary due to facility lighting, printing limitations and dye lot differences.

Merci de faire parvenir votre commande par / Please send your order by | F. 514.367.5115 | montreal@ges.com
Service à la clientèle / Customer service | T. 514.367.4848 | 1.877.399.3976



CANWELD EXPO 2017
13-14 septembre 2017
Place Bonaventure

DATE BUTOIR PRIX ESCOMPTÉ / DEADLINE DISCOUNT PRICE
DATE BUTOIR PRIX RÉGULIER / DEADLINE REGULAR PRICE

28 août 2017 August 28, 2017
11 septembre 2017 Sept. 11

DISPONIBILITÉ SELON L' INVENTAIRE - PRIX POUR 1 À 7 JOURS DE LOCATION
AVAILABLE UPON INVENTORY - PRICES FOR 1 TO 7 DAYS OF RENTAL

QTÉ QTY	CODE	DESCRIPTION	\$ Escompté Discount \$	\$ Régulier Regular \$	Total
FAUTEUIL CLUB - SEATING CLUB CHAIRS					
	DX-101	Sofa modulaire Fidji Centre Choix de couleur / Choice of colour: _____	285,00	413,00	
	DX-102	Sofa modulaire Fidji Coin Choix de couleur / Choice of colour: _____	285,00	413,00	
	DX-103	Fauteuil Malibu Choix de couleur / Choice of colour: _____	375,00	544,00	
	DX-104	Sofa modulaire Strip coin <input type="checkbox"/> Blanc/White <input type="checkbox"/> Noir/Black	270,00	392,00	
	DX-105	Sofa modulaire Strip Centre <input type="checkbox"/> Blanc/White <input type="checkbox"/> Noir/Black	240,00	348,00	
	DX-106	Sofa modulaire Vogue plein <input type="checkbox"/> Blanc/White <input type="checkbox"/> Noir/Black	360,00	522,00	
	DX-107	Chaise Barcelona <input type="checkbox"/> Blanc/White <input type="checkbox"/> Noir/Black	264,00	383,00	
	DX-108	Fauteuil LC2 inspiration Le Corbusier <input type="checkbox"/> Blanc/White <input type="checkbox"/> Noir/Black	330,00	479,00	
	DX-109	Fauteuil Madmen Solo <input type="checkbox"/> Blanc/White <input type="checkbox"/> Noir/Black	330,00	479,00	
	DX-110	Fauteuil Roméo noir / Black	360,00	522,00	
	DX-113	Fauteuil Juliette <input type="checkbox"/> Blanc/White <input type="checkbox"/> Noir/Black	330,00	479,00	

CANAPÉS ET CAUSEUSES / SEATING - SOFAS AND LOVESEATS

	DX-201	Sofa Malibu Trio Choix de couleur / Choice of colour: _____	685,00	993,00	
	DX-202	Sofa Strip Duo <input type="checkbox"/> Blanc/White <input type="checkbox"/> Noir/Black	480,00	696,00	
	DX-204	Sofa Strip Trio <input type="checkbox"/> Blanc/White <input type="checkbox"/> Noir/Black	720,00	1044,00	
	DX-206	Sofa Vogue demi <input type="checkbox"/> Blanc/White <input type="checkbox"/> Noir/Black	315,00	457,00	
	DX-208	Sofa Madmen Duo <input type="checkbox"/> Blanc/White <input type="checkbox"/> Noir/Black	570,00	827,00	
	DX-209	Sofa Madmen Trio <input type="checkbox"/> Blanc/White <input type="checkbox"/> Noir/Black	690,00	1001,00	

Vous devez OBLIGATOIREMENT joindre le formulaire d'autorisation de carte de crédit à ce formulaire. Toutes les commandes sont soumises aux politiques de paiement et aux limites de responsabilités de GES Canada Ltée stipulées dans ce catalogue de l'exposant.

Frais d'annulation: Après le début du montage du salon, toute annulation sera facturée à 100% du coût original.
The payment & credit card authorization form MUST accompany this form. All orders are governed by the GES Canada Ltd Payment Policy and Limits of Liability & Responsibility as specified in this Exhibitor Kit.

Cancellation fees: Items cancelled after move-in begins will be charged at 100% of the original price and 100% after installation .

Montant / Amount	\$
R101720233 - TPS 5% GST	\$
1002260545 - TVQ 9.975% QST	\$
TOTAL	\$
COMPAGNIE / COMPANY	# STAND BOOTH

Retourner votre commande / Send your order form to : montreal@ges.com or by fax : 514-367-5115
Service à la clientèle / Customer Services: 514-367-4848/1-877-399-3976



CANWELD EXPO 2017
13-14 septembre 2017
Place Bonaventure

DATE BUTOIR PRIX ESCOMPTÉ / DEADLINE DISCOUNT PRICE
DATE BUTOIR PRIX RÉGULIER / DEADLINE REGULAR PRICE

28 août 2017 August 28, 2017

11 septembre 2017 Sept. 11

DISPONIBILITÉ SELON L' INVENTAIRE - PRIX POUR 1 À 7 JOURS DE LOCATION
AVAILABLE UPON INVENTORY - PRICES FOR 1 TO 7 DAYS OF RENTAL

QTÉ QTY	CODE	DESCRIPTION	\$ Escompté Discount \$	\$ Régulier Regular \$	Total
OTTOMANS					
	DX-301	Ottoman Fidji Choix de couleur / Choice of colour: _____	225,00	326,00	
	DX-302	Long banc Fidji - Blanc /White	525,00	761,00	
	DX-303	Pouf Malibu cube Choix de couleur / Choice of colour: _____	195,00	283,00	
	DX-304	Pouf Malibu rectangle Choix de couleur / Choice of colour: _____	210,00	305,00	
	DX-305	Ottoman Strip carré <input type="checkbox"/> Blanc/White <input type="checkbox"/> Noir/Black	210,00	305,00	
	DX-306	Ottoman Vogue <input type="checkbox"/> Blanc/White <input type="checkbox"/> Noir/Black	285,00	413,00	
	DX-307	Pouf Vogue rond <input type="checkbox"/> Blanc/White <input type="checkbox"/> Noir/Black	210,00	305,00	
CHAISES / CHAIRS					
	DX-401	Chaise Milan Choix de couleur / Choice of colour: _____	95,00	138,00	
	DX-402	Fauteuil Président / President Chair Noir/Black	285,00	413,00	
TABOURETS / BARSTOOLS					
	DX-501	Tabouret Sprint Stainless - Blanc / White	68,00	99,00	
	DX-502	Tabouret Broadway Stainless <input type="checkbox"/> Blanc/White <input type="checkbox"/> Noir/Black	85,00	123,00	
	DX-503	Tabouret Cosmo Chrome ajustable <input type="checkbox"/> Blanc/White <input type="checkbox"/> Noir/Black	155,00	225,00	
	DX-504	Tabouret Industriel Métal <input type="checkbox"/> Argent / Silver <input type="checkbox"/> Noir/Black	135,00	196,00	
	DX-505	Tabouret Loft avec dossier <input type="checkbox"/> Blanc/White <input type="checkbox"/> Gris/Grey	155,00	225,00	
<p>Vous devez OBLIGATOIREMENT joindre le formulaire d'autorisation de carte de crédit à ce formulaire. Toutes les commandes sont soumises aux politiques de paiement et aux limites de responsabilités de GES Canada Ltée stipulées dans ce catalogue de l'exposant.</p> <p>Frais d'annulation: Après le début du montage du salon, toute annulation sera facturée à 100% du coût original.</p> <p>The payment & credit card authorization form MUST accompany this form. All orders are governed by the GES Canada Ltd Payment Policy and Limits of Liability & Responsibility as specified in this Exhibitor Kit.</p> <p>Cancellation fees: Items cancelled after move-in begins will be charged at 100% of the original price and 100% after installation .</p>			Montant / Amount		\$
			R101720233 - TPS 5% GST		\$
			1002260545 - TVQ 9.975% QST		\$
			TOTAL		\$
			COMPAGNIE / COMPANY	# STAND BOOTH	

Retourner votre commande / Send your order form to : montreal@ges.com or by fax : 514-367-5115
Service à la clientèle / Customer Services: 514-367-4848/1-877-399-3976



CANWELD EXPO 2017
13-14 septembre 2017
Place Bonaventure

DATE BUTOIR PRIX ESCOMPTÉ / DEADLINE DISCOUNT PRICE
DATE BUTOIR PRIX RÉGULIER / DEADLINE REGULAR PRICE

28 août 2017 August 28, 2017
11 septembre 2017 Sept. 11

DISPONIBILITÉ SELON L' INVENTAIRE - PRIX POUR 1 À 7 JOURS DE LOCATION
AVAILABLE UPON INVENTORY - PRICES FOR 1 TO 7 DAYS OF RENTAL

QTÉ QTY	CODE	DESCRIPTION	\$ Escompté Discount \$	\$ Régulier Regular \$	Total
TABLES - COCKTAIL / CRUISER TABLE					
	DX-601	Table Cocktail Tonic Stainless Blanc - White	165 \$	239 \$	
	DX-601	Table Cocktail Tonic Stainless Choix de couleur / Choice of colour: _____	215 \$	312 \$	
	DX-602	Table Commune Tonic Stainless Blanc - White	330 \$	479 \$	
	DX-602	Table Commune Tonic Stainless Noir - Black	405 \$	587 \$	
	DX-603	Table Console Tonic Stainless Blanc - White	315 \$	457 \$	
	DX-603	Table Console Tonic Stainless Noir - Black	405 \$	587 \$	
	DX-604	Table Cocktail Cosmo Noir - Black <input type="checkbox"/> Rouge - Red <input type="checkbox"/> Blanc - White <input type="checkbox"/>	145 \$	210 \$	

TABLES

	DX-701	Table à dîner /Dinner Table Stainless Blanc - White	330,00	479,00	
	DX-702	Table à dîner /Dinner Table Stainless Blanc - White	330,00	479,00	
	DX-703	Table à dîner /Dinner Table Stainless Blanc - White	375,00	544,00	
	DX-704	Table à dîner /Dinner Table Stainless Blanc - White	395,00	573,00	
	DX-705	Table Mezzo Stainless Blanc - White	165,00	239,00	
	DX-705	Table Mezzo Stainless Choix de couleur / Choice of colour: _____	240,00	348,00	
	DX-706	Table d'Appoint Piccolo Stainless Blanc - White	120,00	174,00	
	DX-706	Table d'Appoint Piccolo Stainless Noir - Black <input type="checkbox"/> Mirroir - Mirror <input type="checkbox"/>	165,00	239,00	
	DX 707	Table à café French Kiss /Coffee Table Noir - Black <input type="checkbox"/> Rouge - Red <input type="checkbox"/> Blanc - White <input type="checkbox"/>	315,00	457,00	
	DX 708	Table à café Kimono/Coffee Table Noir - Black <input type="checkbox"/> Rouge - Red <input type="checkbox"/> Blanc - White <input type="checkbox"/>	315,00	457,00	
	DX 709	Ovale Table à café O /Coffee Table Noir - Black <input type="checkbox"/> Argent - Silver <input type="checkbox"/> Blanc - White <input type="checkbox"/>	315,00	457,00	
	DX 714	Table en coin blanc / White Top corner Ottoman Fidji	65,00	94,00	
	DX 714	Table en U blanc / White U-Shaped Top Ottoman Fidji	65,00	94,00	

Vous devez OBLIGATOIREMENT joindre le formulaire d'autorisation de carte de crédit à ce formulaire. Toutes les commandes sont soumises aux politiques de paiement et aux limites de responsabilités de GES Canada Ltée stipulées dans ce catalogue de l'exposant.

Frais d'annulation: Après le début du montage du salon, toute annulation sera facturée à 100% du coût original.

The payment & credit card authorization form MUST accompany this form. All orders are governed by the GES Canada Ltd Payment Policy and Limits of Liability & Responsibility as specified in this Exhibitor Kit.

Cancellation fees: Items cancelled after move-in begins will be charged at 100% of the original price and 100% after installation .

Montant / Amount	\$
R101720233 - TPS 5% GST	\$
1002260545 - TVQ 9.975% QST	\$
TOTAL	\$
COMPAGNIE / COMPANY	# STAND BOOTH

Retourner votre commande / Send your order form to : montreal@ges.com or by fax : 514-367-5115
Service à la clientèle / Customer Services: 514-367-4848/1-877-399-3976



Plantes & fleurs Plants & Flowers

CANWELD EXPO 2017
13-14 septembre 2017
Place Bonaventure

DATE BUTOIR PRIX ESCOMPTÉ / DEADLINE DISCOUNT PRICE
DATE BUTOIR PRIX RÉGULIER / DEADLINE REGULAR PRICE

28 août 2017 August 28, 2017
11 septembre 2017 Sept. 11

LISTE DE PRIX / PRICE LIST

Qté/Qty	Code	Description	\$ Escompté Discount \$	\$ Régulier Regular \$	Total
	0110	Plantes tropicales vertes / <i>Green tropical plants</i> (3' - 5' haut/tall)	100,00 \$	145,00 \$	
	0110-A	Plantes tropicales vertes / <i>Green tropical plants</i> (6' - 7' haut/tall)	120,00 \$	174,00 \$	
	0110-A	Plantes tropicales vertes / <i>Green tropical plants</i> (7' - 8' haut/tall)	160,00 \$	232,00 \$	
	0113	Fougère / <i>Boston Fern</i>	80,00 \$	116,00 \$	
	0111	Chrysanthème / <i>Chrysanthemums</i>	50,00 \$	73,00 \$	
	0112	Azalées / <i>Azaleas</i>	80,00 \$	116,00 \$	



0110



0110-A



0113



0111



0112

0115	Arrangement de fleurs fraîchement coupées <i>Fresh cut flower arrangement</i>	Selon votre budget/ <i>Based on your budget</i>	\$
------	--	--	----



Arrangement sur demande, en fonction de vos besoins, au couleur de votre compagnie et de votre budget!
Communiquez avec nous!

Custom-designed as per your needs, brand colors and budget!
Contact us!

Vous devez OBLIGATOIREMENT joindre le formulaire d'autorisation de carte de crédit à ce formulaire. Toutes les commandes sont soumises aux politiques de paiement et aux limites de responsabilités de GES Canada Ltée stipulées dans ce catalogue de l'exposant.

Frais d'annulation: Après le début du montage du salon, toute annulation sera facturée à 100% du coût original.

The payment & credit card authorization form MUST accompany this form. All orders are governed by the GES Canada Ltd. Payment Policy and Limits of Liability & Responsibility as specified in this Exhibitor Kit.

Cancellation fees: Items cancelled after move-in begins will be charged at 100% of the original price.

Montant / Amount	\$
104060264 - TPS 5% GST	\$
1001673382 - TVQ 9.975% QST	\$
TOTAL	\$
COMPAGNIE / COMPANY	# stand Booth #

Merci de faire parvenir votre commande par / Please send your order by: F. 514.367.5115 - montreal@ges.com
Service à la clientèle / Customer Service 514.367.4848 / 1.877. 399.3976

The benefits of renting a personalized booth:

- Turnkey solutions according to your budget
- Powerful visual impact
- Infinite design possibilities
- Priority set-up
- Professional on-site service throughout the event



Your successful trade show is just a phone call or click away...

- 514-367-4848
- stand@ges.com





Location de stand Exhibit Rental

MB-21



* IMAGE/LOGO: OPTION

MB-22



* IMAGE/LOGO: OPTION

MB-23



* IMAGE/LOGO: OPTION

MB-24



* IMAGE/LOGO: OPTION

Communiquez avec nous pour personnaliser le stand à votre image!

Demandez votre soumission maintenant

Contact us to customize Exhibit Rentals to your brand!

Ask for a quote

Choix de couleur de panneaux

Choice of panels color



Noir Black Gris Grey Blanc White Red Rouge Bleu Blue Vert Green Bourgogne Burgundy



Cognac Espresso Rainuré Slatted

Choix de couleur de tapis

Choice of carpet color



Noir Black Gris Grey Red Rouge Bleu Blue

MB-25

* IMAGE/LOGO: OPTION



MB-27

* IMAGE/LOGO: OPTION



* IMAGE/LOGO: OPTION

MB-26



Communiquiez avec nous pour personnaliser le stand à votre image!

Demandez votre soumission maintenant

Contact us to customize Exhibit Rentals to your brand!

Ask for a quote

Choix de couleur de panneaux

Choice of panels color



Noir Black Gris Grey Blanc White Red Rouge Bleu Blue Vert Green Bourgogne Burgundy



Cognac Espresso Rainuré Slatted

Choix de couleur de tapis

Choice of carpet color

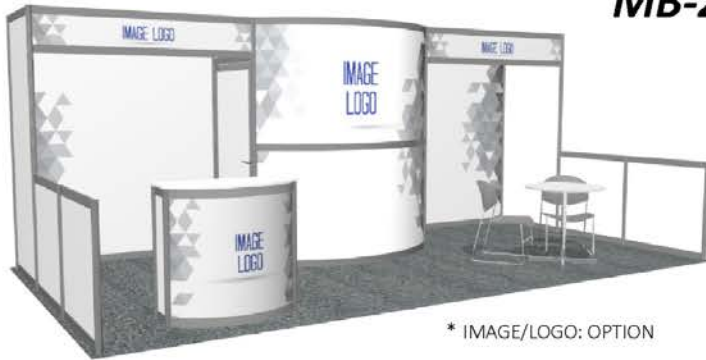

Noir Black Gris Grey Red Rouge Bleu Blue

MB-28

* IMAGE/LOGO: OPTION

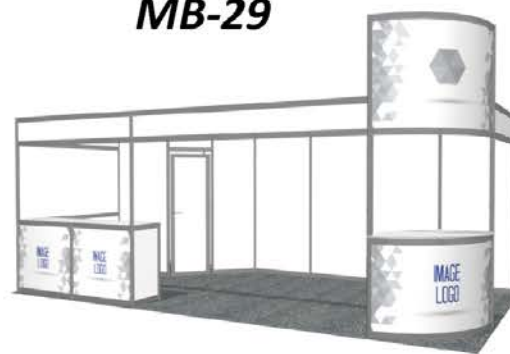
MB-29

Communiquez avec nous pour personnaliser le stand à votre image!

Demandez votre soumission maintenant

Contact us to customize Exhibit Rentals to your brand!

Ask for a quote

Choix de couleur de panneaux
Choice of panels color

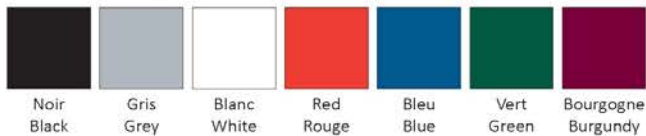

Choix de couleur de tapis
Choice of carpet color



CANWELD EXPO 2017
13-14 septembre 2017
Place Bonaventure

DATE BUTOIR PRIX ESCOMPTÉ / DEADLINE DISCOUNT PRICE
DATE BUTOIR PRIX RÉGULIER / DEADLINE REGULAR PRICE

28 août 2017 August 28, 2017

11 septembre 2017 Sept. 11

***Prix additionnel sur place /Extra Charge for onsite order**

LISTE DE PRIX / PRICE LIST					
Qté/Qty	Code	Description	\$ Escompté Discount \$	\$ Régulier Regular \$	Total
	MB-21	10' x 10' - 1 comptoir, 2 tabourets, tapis, 1 tablette, 1 corbeille à papier et 1 rail de 3 projecteurs / 10' x 10' - 1 counter, 2 bar stools, carpet, 1 shelf, 1 waste basket and 1x 3 spot tracklight	1 319,00 \$	1 913,00 \$	
	MB-22	10' x 10' - 1 table ronde, 2 chaises, tapis, 1 tablette, 1 corbeille à papier / 10' x 10' - 1 round table, 2 chairs, carpet, 1 shelf, 1 waste basket	1 433,00 \$	2 078,00 \$	
	MB-23	10' x 10' - 1 comptoir courbé, 1 tabouret, tapis, 1 tablette, 1 corbeille à papier, 1 rail de 3 projecteurs / 10' x 10' - 1 curved counter, 1 bar stool, carpet, 1 shelf, 1 waste basket, 1x 3 spot tracklight	1 578,00 \$	2 288,00 \$	
	MB-24	10' x 10' - 1 comptoir courbé, 2 tabourets, tapis, 1 tablette, 1 corbeille à papier, 1 rail de 3 projecteurs / 10' x 10' - 1 curved counter, 2 bar stools, carpet, 1 shelf, 1 waste basket, 1x 3 spot tracklight	1 721,00 \$	2 495,00 \$	
	MB-25	10' x 20' - 1 comptoir, 2 tabourets, 1 table ronde, 2 chaises, tapis, 2 tablettes, 1 corbeille à papier et 2 rail de 3 projecteurs / 10' x 20' - 1 counter, 2 bar stools, 1 round table, 2 chairs, carpet, 2 shelves, 1 waste basket and 2 x 3 spot tracklight	2 145,00 \$	3 110,00 \$	
	MB-26	10' x 20' - 1 comptoir courbé, 2 tabourets, tapis, 2 tablettes, 1 corbeille à papier et 2 projecteurs ajustables / 10' x 20' - 1 curved counter, 2 bar stools, carpet, 2 shelves, 1 waste basket and 2 adjustable spots	2 167,00 \$	3 142,00 \$	
	MB-27	10' x 20' - 2 comptoirs, 2 tabourets, tapis, 2 tablettes, 1 corbeille à papier et 2 rail de 3 projecteurs / 10' x 20' - 2 counters, 2 bar stools, carpet, 2 shelves, 1 waste basket and 2 x 3 spot tracklight	2 431,00 \$	3 525,00 \$	
	MB-28	10' x 20' - 1 comptoir courbé, 2 tabourets, 1 table ronde, 2 chaises, tapis, 2 tablettes, 1 corbeille à papier, 2 rail de 3 projecteurs / 10' x 20' - 1 curved counter, 2 bar stools, carpet, 1 round table, 2 chairs, 2 shelves, 1 waste basket, 2 x 3 spot tracklight	2 879,00 \$	4 175,00 \$	
	MB-29	10' x 20' - 2 comptoirs, 1 comptoir courbé, 2 tabourets, tapis, 2 tablettes, 1 corbeille à papier, 2 rail de 3 projecteurs / 10' x 20' - 2 counters, 1 curved counter, 2 bar stools, carpet, 2 shelves, 1 waste basket, 2 x 3 spot tracklight	3 181,00 \$	4 612,00 \$	

NOTES

Nom sur l'affiche d'identification / Name to be printed on Header Sign

Couleur de tapis

- Gris/Grey Rouge/Red
 Noir/Black Bleu/Blue

Couleur de texte - Enseigne

- Noir / Black Rouge / Red
 Bleu / Blue Vert / Green

Choix de couleur de panneaux fibrex / Fibrex Panel Colour Choice

- Noir / Black Blanc / White Cognac/ Cognac Espresso

Choix de couleur de panneaux velcro / Velcro Panel Colour Choice

- Noir / Black Bleu / Blue Gris / Grey

Vous devez OBLIGATOIREMENT joindre le formulaire d'autorisation de carte de crédit à ce formulaire. Toutes les commandes sont soumises aux politiques de paiement et aux limites de responsabilités de GES Canada énoncées dans ce catalogue de l'exposant.

Frais d'annulation: Après le début du montage du salon, toute annulation sera facturée à 100% du coût original.

The payment & credit card authorization form MUST accompany this form. All orders are governed by the GES Canada Ltd. Payment Policy and Limits of Liability & Responsibility as specified in this Exhibitor Kit.

Cancellation fees: Items cancelled after move-in begins will be charged at 100% of the original price and 100% after installation.

Montant / Amount	\$
104060264 - TPS 5% GST	\$
1001673382 - TVQ 9.975% QST	\$
TOTAL	

COMPAGNIE / COMPANY

STAND / BOOTH

Merci de faire parvenir votre commande par / Please send your order by: F. 514.367.5115 - montreal@ges.com
Service à la clientèle / Customer Service 514.367.4848 / 1.877. 399.3976

Enhance your presence on the show floor !

- Backlit signs
- Banners & hanging signs
- Floor/carpet decals
- Easel & freestanding signs
- Posters
- Custom cut signs & decals
- Backwall murals
- Branding graphics

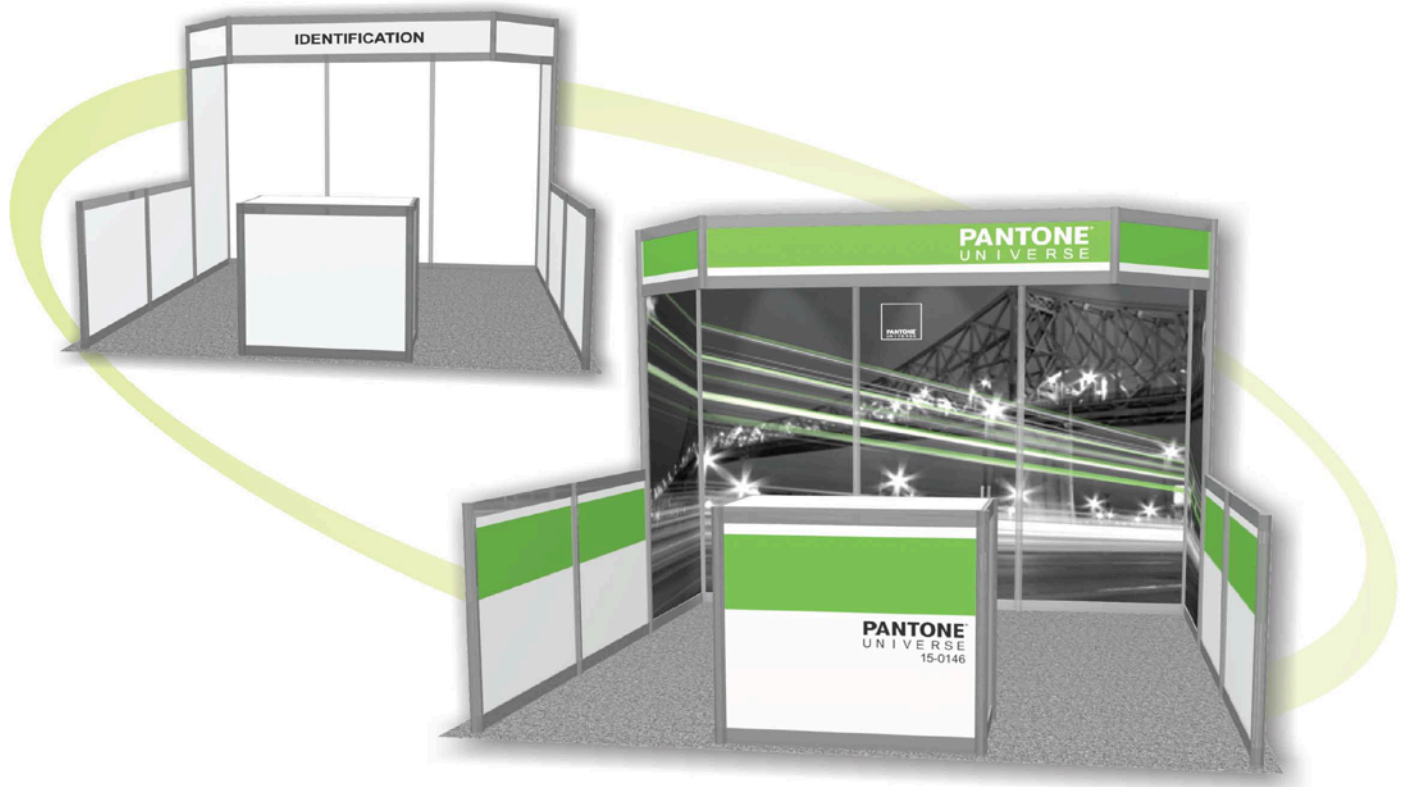



Transfer for graphic file

Platforms:

PC & Macintosh. All type (fonts) must be converted to curve or outline, or you must supply fonts (screen and printer).

File formats :

- High Resolution PDF
- Vector file : .EPS, .AI, .CDR
- Vector file : .EPS, .AI, .CDR
- Bitmap files (TIF, JPG, BMP, PSD) must be at 100 d.p.i. at final size

(a good tip: work with 400 d.p.i. files as usual, but at 25% of the final size of your sign).

Supported colour mode is CMYK

Always send a printed proof with all the Pantone color correspondance. For E-Mails. and the FTP Users, be sure to include a detailed PDF copy with all the Pantone color correspondance with your file.

Office Programs, logos and or graphics used for your WEB site are useless to produce large format printing.

Supported programs:

Coreldraw X8, Photoshop CC, Illustrator CC, Adobe Acrobat (PDF high resolution),

DO NOT FORGET TO INDICATE THE SOURCE AND NAME OF YOUR FILES (COREL, PHOTOSHOP, ILLUSTRATOR, ETC.)

N.B. For InDesign files, please save your file as PDF (high resolution).

FTP site

FTP site is accessible via your web browser.

<https://file.ges.com>

If you have any questions, please do not hesitate to contact us, we will do our best to make your life easier.



Services électriques Electrical Services

CANWELD EXPO 2017

13-14 septembre 2017

Place Bonaventure

DATE BUTOIR PRIX ESCOMPTÉ / DEADLINE DISCOUNT PRICE
DATE BUTOIR PRIX RÉGULIER / DEADLINE REGULAR PRICE

28 août 2017 August 28, 2017

11 septembre 2017 Sept. 11

LISTE DE PRIX / PRICE LIST					
Qté/Qty	Code	Description	\$ Escompté Discount \$	\$ Régulier Regular \$	Total
Électricité / Electrical					
	0206	1 Prise de courant 1500 watts ou moins / 110V positionnée à l'arrière du stand - si positionnement autre voir item # 0310. 1 outlet for 1500 watt or less / 110V positioned at the rear of the booth - If positioned other then see item # 0310.	150,00 \$	218,00 \$	
	0310	Autre positionnement tel que; fils en dessous du tapis, rallonge, prise du plafond. Any other positioning of power such as wire under the carpet, extension, outlet from the ceiling.	62,00 \$	90,00 \$	
	0210	15 Amp. 208V monophasé / 15 Amp. 208V power 1 phase	302,00 \$	438,00 \$	
	0213	20 Amp. 208V monophasé / 20 Amp. 208V power 1 phase	394,00 \$	571,00 \$	
	0216	30 Amp. 208V monophasé, (Ajouter l'item #0301) 30 Amp. 208V power 1 phase (Add item # 0301)	488,00 \$	708,00 \$	
	0217	30 Amp. 208V triphasé, (Ajouter l'item #0301) 30 Amp. 208V 3 phases (Add item # 0301)	488,00 \$	708,00 \$	
	0218	30 Amp. 550V triphasé, (Ajouter l'item #0301) 30 Amp. 550V 3 phases (Add item # 0301)	574,00 \$	832,00 \$	
	0229-A	60 Amp. 110-208V triphasé, (Ajouter l'item #0301) 60 Amp. 110-208V 3 phases (Add item # 0301)	615,00 \$	892,00 \$	
	0207	Projecteur 750 watts suspendu du plafond / 750 watt flood from ceiling	173,00 \$	251,00 \$	
	0257	Rallonge électrique / Extension cord	37,00 \$	54,00 \$	
	0258	Barre multiprises / Power Bar	37,00 \$	54,00 \$	
	0301	Branchement et débranchement / Connection and disconnection	105,00 \$	152,00 \$	
Note: Installations électriques et éclairage (CA 110-208 volts monophasé) Electrical connections and lighting (110-208Volt Ac single phase)			Montant / Amount		\$
			104060264 - TPS 5% GST		\$
			1001673382 - TVQ 9.975% QST		\$
			TOTAL		\$
<p>Vous devez OBLIGATOIREMENT joindre le formulaire d'autorisation de carte de crédit à ce formulaire. Toutes les commandes sont soumises aux politiques de paiement et aux limites de responsabilités de GES Canada Ltée stipulées dans ce catalogue de l'exposant.</p> <p>Frais d'annulation: Après le début du montage du salon, toute annulation sera facturée à 100% du coût original.</p> <p>The payment & credit card authorization form MUST accompany this form.All orders are governed by the GES Canada Ltd. Payment Policy and Limits of Liability & Responsibility as specified in this Exhibitor Kit.</p> <p>Cancellation fees: Items cancelled after move-in begins will be charged at 100% of the original price</p>			Compagnie / Company		STAND #
<p>Merci de faire parvenir votre commande par / Please send your order by: F. 514.367.5115 - montreal@ges.com Service à la clientèle / Customer Service 514.367.4848 / 1.877. 399.3976</p>					



Services électriques Additionnel Additional Electrical Services

CANWELD EXPO 2017
13-14 septembre 2017
Place Bonaventure

DATE BUTOIR PRIX ESCOMPTÉ / DEADLINE DISCOUNT PRICE
DATE BUTOIR PRIX RÉGULIER / DEADLINE REGULAR PRICE

28 août 2017 August 28, 2017
11 septembre 2017 Sept. 11

LISTE DE PRIX / PRICE LIST

Qté/Qty	Code	Description	\$ Escompté Discount \$	\$ Régulier Regular \$	Total
Électricité / Electrical					
	0212	110-Volts monophasé 20 amp / 110Volt 1 phase 20 amp.	237,00 \$	344,00 \$	
	0213-A	110-208Volts monophasé 20 amp. / 110-208Volt 1 phase 20 amp.	425,00 \$	616,00 \$	
	0214-A	110-208Volts triphasé 20 amp. / 110-208Volt 3 phases 20 amp.	425,00 \$	616,00 \$	
	0216-A	110-208Volts monophasé 30 amp. / 110-208Volt 1 phase 30 amp.	519,00 \$	753,00 \$	
	0217-A	110-208Volts triphasé 30 amp. / 110-208Volt 3 phases 30 amp.	519,00 \$	753,00 \$	
	0220-A	110-208Volts monophasé 40 amp. / 110-208Volt 1 phase 40 amp.	540,00 \$	783,00 \$	
	0221-A	110-208Volts triphasé 40 amp. / 110-208Volt 3 phases 40 amp.	540,00 \$	783,00 \$	
	0228-A	110-208Volts monophasé 60 amp. / 110-208Volt 1 phase 60 amp.	615,00 \$	892,00 \$	
	0229-A	110-208Volts triphasé 60 amp. / 110-208Volt 3 phases 60 amp.	615,00 \$	892,00 \$	
	0231-A	110-208Volts monophasé 100 amp. / 110-208Volt 1 phase 100 amp.	907,00 \$	1 315,00 \$	
	0232-A	110-208Volts triphasé 100 amp. / 110-208Volt 3 phases 100 amp.	907,00 \$	1 315,00 \$	
	0213	208Volts monophasé 20 amp. / 208Volt 1 phase 20 amp.	394,00 \$	571,00 \$	
	0214	208Volts triphasé 20 amp. / 208Volt 3 phases 20 amp.	394,00 \$	571,00 \$	
	0216	208Volts monophasé 30 amp. / 208Volt 1 phase 30 amp.	488,00 \$	708,00 \$	
	0217	208Volts triphasé 30 amp. / 208Volt 3 phases 30 amp.	488,00 \$	708,00 \$	
	0220	208Volts monophasé 40 amp. / 208Volt 1 phase 40 amp.	511,00 \$	741,00 \$	
	0221	208Volts triphasé 40 amp. / 208Volt 3 phases 40 amp.	511,00 \$	741,00 \$	
	0228	208Volts monophasé 60 amp. / 208Volt 1 phase 60 amp.	590,00 \$	856,00 \$	
	0235-A	110-208Volts triphasé 200 amp. / 110- 208Volt 3 phases 200 amp.	1 166,00 \$	1 691,00 \$	
	0236-B	208Volts triphasé 300 amp. / 208Volt 3 phases 300 amp.	1 305,00 \$	1 892,00 \$	
	301	+ branchement et débranchement / + connection and disconnection	105,00 \$	152,00 \$	

Note: Prix pour moteurs au-dessus de 5cv disponibles sur demande
Prices for motors above 5cv available on request

Vous devez OBLIGATOIREMENT joindre le formulaire d'autorisation de carte de crédit à ce formulaire. Toutes les commandes sont soumises aux politiques de paiement et aux limites de responsabilités de GES Canada Ltée stipulées dans ce catalogue de l'exposant.
Frais d'annulation: Après le début du montage du salon, toute annulation sera facturée à 100% du coût original.

The payment & credit card authorization form MUST accompany this form. All orders are governed by the GES Canada Ltd. Payment Policy and Limits of Liability & Responsibility as specified in this Exhibitor Kit.
Cancellation fees: Items cancelled after move-in begins will be charged at 100% of the original price

Montant / Amount	\$
104060264 - TPS 5% GST	\$
1001673382 - TVQ 9.975% QST	\$
TOTAL	\$
Compagnie / Company	STAND #

Merci de faire parvenir votre commande par / Please send your order by:
clientèle / Customer Service 514.367.4848 / 1.877. 399.3976

F. 514.367.5115 - montreal@ges.com Service à la

INSTALLATIONS ÉLECTRIQUES

Indemnité d'annulation. Après le début de l'installation, toute commande sera facturée à 100% du coût original.

MODALITÉS

RÈGLEMENTS

1. Tout exposant possédant des appareils ou systèmes électriques qui présentent des caractéristiques spéciales ayant des exigences supérieures, devra immédiatement en aviser GES Canada Ltée.
2. Tout matériel fourni par GES pour l'installation, la location et l'entretien du matériel électrique demeure la propriété de GES Canada Ltée.
3. Le prix indiqué pour la prise de courant comprend l'installation de la prise à l'arrière du stand. Toute connexion ou disjonction aux bornes d'appareils fait l'objet d'un tarif additionnel.
4. Les prix et les tarifs pour la main-d'œuvre sont basés sur l'échelle de salaires courante ou peuvent être sujets à changement sans préavis.
5. Pour être prise en considération, toute réclamation au sujet des frais encourus pour l'installation électrique devra être présentée avant la clôture du Salon.
6. **Interdiction: Il est interdit à quiconque de partager ou de redistribuer le courant électrique loué par un exposant ou pour le compte d'un exposant.** Le courant électrique loué est pour l'usage exclusif de l'exposant dans son stand ou étalage et ne peut être acheminé ailleurs. *Exemple:* une prise de courant de 1500W ou une alimentation électrique de 100 ampères, louée par un client, fournisseur ou exposant ne doit pas être répartie et redistribuée vers l'étalage ou le stand d'un autre exposant. Dans un tel cas, tout individu ou campagne qui aura passé la commande de location d'électricité, devra aussi assumer le coût du ou des services d'électricité fournis aux autres stands en plus des services d'électricité qu'ils auront commandés. Le tarif chargé à tout exposant utilisant un service d'électricité est le coût d'une prise de courant de 1500W au tarif en vigueur.

1. Le comité d'examineurs a le pouvoir de refuser les installations électriques qui présenteraient des risques de feu et qui ne rencontreraient pas les exigences du Fire Underwriters Investigation Bureau of Canada.
2. Tous les moteurs de plus de 1/2 c.v. doivent être munis d'un démarreur magnétique et d'un sectionneur.
3. Pour fins d'inspection et de dépannage, les fils électriques des stands pré-fabriqués doivent être en tout temps facilement accessibles des deux cotés et de l'arrière du stand.
4. **GES Canada Ltée** ne se rend pas responsable des dommages résultant des pannes d'électricité ou des défauts dans les appareils nécessitant un service électrique de 24 heures.
5. Aucun circuit individuel d'éclairage ne pourra dépasser 1,500 watts. Lorsque le circuit électrique d'un stand est muni de fusibles et qu'il dépasse 2,000 watts, ou 2 circuits, ledit stand devra être pourvu d'un câble d'alimentation 120-208 volts, triphasé.
6. Il n'est pas nécessaire de débrancher les appareils électriques ne fonctionnant pas après les heures de fermeture; le courant électrique est automatiquement coupé au panneau central. Il est strictement défendu de couvrir les lampes de papier, de tissu ou de toute autre matière inflammable durant la nuit.
7. Au moment de la fermeture chaque jour, l'exposant devra lui-même fermer les interrupteurs de tous les appareils en opération.
8. Votre matériel devra être prêt pour le démantèlement dès la clôture de l'exposition. Vous devrez également débrancher tous vos appareils électriques car le courant sera immédiatement coupé.
9. Les prix indiqués comprennent l'installation complète de tous les câbles d'alimentation, tableaux et fils, les frais d'inspection et d'entretien ainsi que l'enlèvement du matériel électrique à la fin de l'exposition. Tout le matériel demeure la propriété de GES Canada Ltée.

ELECTRICAL INSTALLATION

Cancellation policy. All items cancelled after move-in begins, will be charged at 100% of the original price

GENERAL CONDITIONS

ELECTRICAL REGULATIONS

1. Any exhibitor requiring load in excess should notify GES Canada Ltd.
2. All material supplied by GES Canada Ltd for the installation, rental and maintenance of the electrical works remains the property of GES Canada Ltd.
3. The price of an outlet includes the supply of this outlet at the rear of the exhibitor's booth. Any connection or disconnection such as to machine terminals is an additional charge.
4. Prices and labour rates are based on current wage scales and may be subject to change without notice.
5. All claims on electrical charges must be filed prior to the closing of the show to be considered.
6. **No power sharing:** Power that is rented by the exhibitor or by a supplier on behalf of the exhibitor or by any other customer is for use in only exhibit or booth and cannot be shared with another exhibit i.e. a 1500 watt outlet amp. service, etc. rented by one customer, supplier or exhibitor cannot be broken up into smaller units of power and used free of charge in another customer's booth or exhibit. The party that ordered the power will be responsible for the payment of the power supplied to these other booths as well as for the payment of the electrical power originally ordered, all as per listed catalogue prices. The minimum charge to any one exhibitor using power is for one 1500 watt outlet current prices.

1. The board of Electrical Examiners has the power to refuse connections where wiring constitutes a fire hazard, and does not meet the requirements of the Board of Fire Underwriters.
2. All motors above 1/2 hp, must be supplied with their own starters and disconnecting switches.
3. Specialty built displays and panels must have electrical wiring accessible for inspection and trouble shooting at all times; they must be accessible from sides or rear and not solidly built-in.
4. GES Canada Ltd is not responsible for power failure or any other equipment failure and resulting damages on 24-hour electrical service lines.
5. No individual lighting circuit shall exceed 1,500 watts of lighting. Where the exhibitor furnished his own fuse protection for a display board and wattage is over 2,000 or 2 circuits, the board shall be wired for 120-208 volts, 3 wire main feed lines.
6. Do not disconnect any Non-Operating Electrical Units at closing hour of the show. These are turned off at the main switch-board automatically. Do not cover lamps with paper, cloth or other flammable material overnight.
7. Exhibitor must himself disconnect the control switch in his booth of all moving or operating devices before leaving at the closing hour of each show period.
8. Before show breaks on final day, stop your machinery and position it for dismantling, because power cannot be turned on again for hours after.
9. The above prices cover complete installation of all necessary feeders, Panels and Circuit Wiring. Inspection fees, Maintenance Electricians and Dismantling of Electrical Equipment at end of Exhibition. All material remains the property of GES Canada Ltd.



Accrochage Sign Hanging

CANWELD EXPO 2017
13-14 septembre 2017
Place Bonaventure

DATE BUTOIR PRIX ESCOMPTÉ / DEADLINE DISCOUNT PRICE
DATE BUTOIR PRIX RÉGULIER / DEADLINE REGULAR PRICE

28 aout 2017 August 28, 2017
11 septembre 2017 Sept. 11

NOMBRE D'ENSEIGNES / NUMBER OF SIGNS _____	1 lb à 50 lbs (max. 2 points d'encrage) up to 50 pounds (max. 2 drops)		Plus de 50 lbs (prix minium 316\$) Over 50 pounds (minimum price 316\$)	
	Prix escompté	Prix régulier *	Prix escompté	Prix régulier*
Grandeur en pouce / Size in inches _____ X _____	112,00 \$	158,00 \$	158,00 \$	221,00 \$
Poids en livres / Weight in pounds _____	par enseigne / per sign		par point d'ancrage additionnel / per additional Drop	

Pour des exigences spéciales ou autres éléments à accrocher, veuillez communiquer au (514) 367-4848, Service à la clientèle.
For special requirements or other elements to hang, please contact our customer service department at (514) 367-4848.

Tout accrochage ou ancrage au structure de la Place Bonaventure est strictement interdit. Place Bonaventure se réserve le droit d'exiger des frais aux contrevenants.
AVIS: Ce formulaire officiel doit être utilisé pour toute commande d'ACCROCHAGE. Il doit être dûment rempli et retourné à GES Canada Ltée et doit être reçu avant la date

Any hanging or ancring to the structure of Place Bonaventure is strictly prohibited. Place Bonaventure reserves the right to demand compensation to any offender.
NOTICE: This official form must be used for any SIGN HANGING order. It must be correctly filled and return and received at GES Canada Ltd. before the deadline date.

Le présent calcul n'est qu'un estimé. Les coûts réels seront confirmés sur le site. S'il y a lieu, les ajustements nécessaires seront portés à votre carte de crédit.
This calculation is an estimate only. The real costs will be confirmed on show site. If an adjustment should be necessary, the cost will be reflected on your credit card

Responsabilité limitée de GES Canada Ltée
 ● **Responsabilité** - GES Canada Ltée est responsable de pertes ou dommages causés à votre marchandise **UNIQUEMENT** si les dits dommages sont causés par une négligence de GES Canada Ltée.
 ● **Mesures de dédommagement** - Si GES Canada Ltée a été négligent et que cette négligence a causé la perte/dommage de votre matériel, les mesures de dédommagement seront déterminées ainsi:
 a. Les mesures de dédommagement, dans quelconques circonstances (incluant le point b.) seront limitées au moindre coût entre la valeur dépréciée des biens ou le coût de réparation.
 b. Le moindre coût entre: 0,30\$ par livre par morceau, 50,00\$ par morceau ou 1000,00\$ par circonstance.
 GES Canada Ltée ne vend, ni offre des assurances. GES Canada Ltée n'est pas reponsable si la perte ou le bris n'est pas causé par GES Canada Ltée.
GES Canada Ltd Limits of Liability
 ● **Liability** - GES Canada Ltd. is liable for loss or damage to your goods ONLY if the loss or damage was caused by GES Canada Ltd. negligence.
 ● **Measure of Damage** - If GES Canada Ltd. was negligent and the negligence caused either loss or damage to your goods, then the measure of that damage will be determined by the following:
 a. Measure of damages in all situations (including b. below) will be limited by the Depreciated Value of the goods or repair costs, whichever is less.
 b. The lesser of \$0.30 per pound per piece, \$50 per piece, or \$1000 per occurrence.
 GES Canada Ltd does not offer or sell insurance. GES Canada Ltd. is not liable and will not owe for loss or damage to your goods if the damage was not caused by GES Canada Ltd.

Note:	Montant / Amount	
	104060264 - TPS 5% GST	\$
Vous devez OBLIGATOIREMENT joindre le formulaire d'autorisation de carte de crédit à ce formulaire. Toutes les commandes sont soumises aux politiques de paiement et aux limites de responsabilités de GES Canada Ltée stipulées dans ce catalogue de l'exposant. Frais d'annulation: Après le début du montage du salon, toute annulation sera facturée à 100% du coût original. The payment & credit card authorization form MUST accompany this form. All orders are governed by the GES Canada Ltd. Payment Policy and Limits of Liability & Responsibility as specified in this Exhibitor Kit. Cancellation fees: Items cancelled after move-in begins will be charged at 100% of the original price.	1002260545 - TVQ 9.975% QST	\$
	TOTAL	\$
	Compagnie / Company	STAND #

Positionnement / Positioning

ARRIÈRE DU STAND / BACK OF THE BOOTH

ou / or

10' x 10' / 20' x 20'
10' x 20' / 10' x 30'

STAND / BOOTH # _____

CANWELD EXPO 2017
13-14 septembre 2017
Place Bonaventure

DATE BUTOIR PRIX ESCOMPTÉ / DEADLINE DISCOUNT PRICE
DATE BUTOIR PRIX RÉGULIER / DEADLINE REGULAR PRICE

28 août 2017 August 28, 2017
11 septembre 2017 Sept. 11

LISTE DE PRIX / PRICE LIST						
Qté/Qty	Code	Description		\$ Escompté Discount \$	\$ Régulier Regular \$	Total
Plomberie / Plumbing						
	5000-ML50	Eau Voie principal 1/2" / Water Main line 1/2'	Ch./Ea.	191,00 \$	277,00 \$	
	5010-C50	Raccordement 1/2" / Connection, Disconnection 1/2"	Ch./Ea.	32,00 \$	46,00 \$	
	5000-ML75	Eau Voie principal 3/4" / Water Main line 3/4"	Ch./Ea.	210,00 \$	305,00 \$	
	5010-C75	Raccordement 3/4" / Connection, Disconnection 3/4"	Ch./Ea.	42,00 \$	61,00 \$	
	5020-SR	Évier eau froide drain inclus (voir note 2) / Sink cold water drain included (see note 2)		357,00 \$	518,00 \$	
	5020-SH	Évier eau froide et chaude (voir note 1) et drain inclus (voir note 2) Sink cold water and hot water (see note 1) and drain included (see note 2)		387,00 \$	561,00 \$	
	5030-FE	Bassin - Piscine (remplir/vider par unité) 30m ³ approx. / Basin - Pool (fill & empty each) 30m ³ approx.		320,00 \$	464,00 \$	
	5031-FE	Bain - Spa (remplir/vider par unité) / Bath tub - Spa (fill & empty each)		213,00 \$	309,00 \$	
	5040-DF	Drainage par le plancher (Location & installation de tuyaux) ; prix par pied linéaire Drainage by the floor (Rental & installation of pipe) price by linear foot		4,12 \$	6,00 \$	
	5050-MH	Le taux horaire de main-d'œuvre pour travaux additionnels en plomberie Hourly rate for additional plumbing		95,00 \$	133,00 \$	

Note 1: Veuillez prévoir commander les services électriques requis pour faire fonctionner le chauffe-eau (25 gallons). L'eau chaude requise en plus grande quantité doit faire l'objet d'un prix séparé.

Note 2: Aux endroits situés près d'un drain tel qu'identifiés sur le plan, près de certaines colonnes, sinon prévoir des coûts supplémentaires tels que l'item # 5640-DF ci-dessus.

Note 1: Please make sure to order separately the electrical services needed for the water heater (25 gallons). Hot water required in larger quantity must be priced separately.

Veuillez indiquer l'endroit précis de l'installation (X)
Please indicate point of installation (X)



devant du stand / front of booth

Informations supplémentaires / extra information:

Montant / Amount

104060264 - TPS 5% GST

\$

1001673382 - TVQ 9.975% QST

\$

TOTAL

\$

Compagnie / Company

STAND #

Vous devez OBLIGATOIREMENT joindre le formulaire d'autorisation de carte de crédit à ce formulaire. Toutes les commandes sont soumises aux politiques de paiement et aux limites de responsabilités de GES Canada Ltée stipulées dans ce catalogue de l'exposant.

Frais d'annulation: Après le début du montage du salon, toute annulation sera facturée à 100% du coût original.

The payment & credit card authorization form MUST accompany this form. All orders are governed by the GES Canada Ltd Payment Policy and Limits of Liability & Responsibility as specified in this Exhibitor Kit.

Cancellation fees: Items cancelled after move-in begins will be charged at 100% of the original price.



CANWELD EXPO 2017
13-14 septembre 2017
Place Bonaventure

DATE BUTOIR PRIX ESCOMPTÉ / DEADLINE DISCOUNT PRICE
DATE BUTOIR PRIX RÉGULIER / DEADLINE REGULAR PRICE

28 août 2017 August 28, 2017
11 septembre 2017 Sept. 11

LISTE DE PRIX / PRICE LIST

SERVICES AIR COMPRIMÉ / COMPRESSED AIR SERVICES

	Voie principale Main line 1/2" code 5300-ML50	Raccordement Connection code 5300- C50	Voie principale Main line 3/4" code 5300-ML75	Raccordement Connection code 5300- C75	
Prix par unité / Price per unit	278,00 \$	55,00 \$	400,00 \$	87,00 \$	
Nombre requis / Number required					
Sous- total / Sub total					

tarif horaire pour travail supplémentaire 98\$
Hourly rate for additional work 98\$

DEBIT TOTAL DE L'AIR REQUIS : _____ (CFM=piéd cube par minute) VOTRE RACCORD: MALE FEMELLE

PRESSION REQUISE: _____ P.S.I.

Ces informations sont obligatoires

TOTAL CFM NEEDED: _____ (CFM=cubic feet per minute) YOUR CONNECTION: MALE FEMALE

REQUIRED AIR PRESURE: _____ P.S.I.

This information is mandatory

Il est de votre responsabilité de vous assurer d'avoir en votre possession l'équipement nécessaire pour toute filtration spécifique. / It is your responsibility to have in your possession the necessary equipment for any specific filtration.

Exigences spéciales / Special requirements:

Veuillez indiquer l'endroit précis d'installation (X)
Please indicate point(s) of installation (x)



Devant du stand / Front of Booth

AVIS: Ce formulaire officiel doit être utilisé pour toute commande d'AIR COMPRIMÉE. Il doit être dûment rempli et retourné à GES Canada Ltée et doit être reçu avant la date limite. Une charge additionnelle de 40% sera appliquée sur toute commande reçue après cette date. LA FICHE TECHNIQUE DE CHAQUE ÉQUIPEMENT DOIT ACCOMPAGNER CE FORMULAIRE.
Notice: This official form must be used for any COMPRESSED AIR order. It must be correctly filled out, returned, and received at GES Canada Ltd. before the deadline date. An additional charge of 40% will be applicable on any order received after this date. THE TECHNICAL DATA SHEET FOR EACH EQUIPMENT MUST BE PROVIDED WITH THIS FORM.

Le présent calcul n'est qu'un estimé. Les coûts réels seront confirmés sur le site. S'il y a lieu, les ajustements nécessaires seront portés à votre carte de crédit.
This calculation is an estimate only. The real costs will be confirmed on show site. If an adjustment should be necessary, the cost will be reflected on your credit card

Responsabilité limitée de GES Canada Ltée

- Responsabilité - GES Canada Ltée est responsable de pertes ou dommages causés à votre marchandise UNIQUEMENT si les dits dommages sont causés par une négligence de GES Canada Ltée..
 - Mesures de dédommagement - Si GES Canada Ltée a été négligent et que cette négligence a causé la perte/dommage de votre matériel, les mesures de dédommagement seront déterminées ainsi:
 - Les mesures de dédommagement, dans quelconques circonstances (incluant le point b.) seront limitées au moindre coût entre la valeur dépréciée des biens ou le coût de réparation.
 - Le moindre coût entre: 0,30\$ par livre par morceau, 50,00\$ par morceau ou 1000,00\$ par circonstance.
- GES Canada Ltée ne vend, ni offre des assurances. GES Canada Ltée n'est pas responsable si la perte ou le bris n'est pas causé par GES Canada Ltée .
- GES Canada Ltd. Limits of Liability**
- Liability - GES Canada Ltd is liable for loss or damage to your goods ONLY if the loss or damage was caused by GES Canada Ltd. negligence.
 - Measure of Damage - If GES Canada Ltd. was negligent and the negligence caused either loss or damage to your goods, then the measure of that damage will be determined by the following:
 - Measure of damages in all situations (including b. below) will be limited by the Depreciated Value of the goods or repair costs, whichever is less.
 - The lesser of \$0.30 per pound per piece, \$50 per piece, or \$1000 per occurrence.
- GES Canada Ltd does not offer or sell insurance. GES Canada Ltd. is not liable and will not owe for loss or damage to your goods if the damage was not caused by GES Canada Ltd .

Note:

Vous devez OBLIGATOIREMENT joindre le formulaire d'autorisation de carte de crédit à ce formulaire.
Toutes les commandes sont soumises aux politiques de paiement et aux limites de responsabilités de GES Spécialiste mondial de l'événement stipulées dans ce catalogue de l'exposant.
Frais d'annulation: Après le début du montage du salon, toute annulation sera facturée à 100% du coût original.

The payment & credit card authorization form MUST accompany this form. All orders are governed by the GES Global Experience Specialists Payment Policy and Limits of Liability & Responsibility as specified in this Exhibitor Kit.
Cancellation fees: Items cancelled after move-in begins will be charged at 100% of the original price.

Montant / Amount	\$
104060264 - TPS 5% GST	\$
1001673382 - TVQ 9.975% QST	\$
TOTAL	\$
Compagnie / Company	STAND #



POSITIONNEMENT DANS LE STAND IN BOOTH FORKLIFT

CANWELD EXPO 2017
13-14 septembre 2017
Place Bonaventure

DATE BUTOIR PRIX ESCOMPTÉ / DEADLINE DISCOUNT PRICE
DATE BUTOIR PRIX RÉGULIER / DEADLINE REGULAR PRICE

28 août 2017 Aug 28, 2017
11 septembre 2017 Sept. 11

LISTE DE PRIX / PRICE LIST

Ce service est offert aux exposants qui ont besoin d'assistance dans leur stand pour le positionnement d'équipements lourds (UNE CHARGE MINIMUM D'UNE HEURE PAR COMMANDE, INCLUANT INSTALLATION ET DÉMONTAGE).

In booth forklift services are available to exhibitors requiring assistance with positioning of exhibitor materials within your booth space (MINIMUM CHARGE OF 1 HOUR PER ORDER, INCLUDING INSTALLATION AND DISMANTLING).

CE SERVICE N'EST PAS PAYÉ PAR LE PROMOTEUR / THIS SERVICE IS NOT PAID BY SHOW MANAGEMENT

<p>Temps régulier : lundi - vendredi 8h00 - 16h00 175\$ / heure</p> <p>Straight time Monday - Friday 8:00am - 4:00pm 175\$ per hour</p>	<p>Temps supplémentaire lundi - vendredi 16h00 - 18h00 sam. & dim. 8h00 - 16h00 264\$ / heure</p> <p>Overtime Monday - Friday 4:00pm - 6:00pm and Sat & Sun 8:00am - 4:00pm 264\$ per hour</p>	<p>Temps double lundi - vendredi après 18H00 sam. & dim. et jours fériés après 16H00 353\$ / heure</p> <p>Double time Monday - Friday after 6:00pm Sat., Sun. & all Holidays after 4:00pm 353\$ per hour</p>
---	--	--

Une charge additionnelle de 40% sera appliquée sur toute commande reçue sur le site. Tous les taux comprennent le chariot élévateur et le chauffeur (taxes en sus).
A 40% surcharge will be applied to on-site orders. All rates include forklift and driver (taxes not included).

S.v.p. **compléter** les informations suivantes:
Please complete the following information:

Nom du superviseur / Supervisor name: _____ (l'exposant doit être présent pour superviser / Exhibitor must be present to supervise)

Installation requise pour / Installation time required : _____

_____	_____	_____	_____	_____
Day	Date	Mois/Month	# heures / # hours	# chariots/# of forklifts

Démontage requis pour / Dismantling time required : _____

_____	_____	_____	_____	_____
Day	Date	Mois/Month	# heures / # hours	# chariots/# of forklifts

Temps approximatif / Approximate time:

Montage / Move-In Départ/Start: _____ am / pm Fin/Finish: _____ am / pm total heures/Total hours: _____
 Démontage / Move-Out Départ/Start: _____ am / pm Fin/Finish: _____ am / pm total heures/Total hours: _____

Les services de plus d'une heure seront facturés par tranches de 30 minutes par chariot élévateur.
Services over 1 hour will be charged in 1/2 hour increments per forklift.

Responsabilité limitée de GES Canada Ltée

● **Responsabilité** - GES Canada Ltée est responsable de pertes ou dommages causés à votre marchandise **UNIQUEMENT** si les dits dommages sont causés par une négligence de GES Canada Ltée.
 ● **Mesures de dédommagement** - Si GES Canada Ltée a été négligent et que cette négligence a causé la perte/dommage de votre matériel, les mesures de dédommagement seront déterminées ainsi:
 a. Les mesures de dédommagement, dans quelconques circonstances (incluant le point b.) seront limitées au moindre coût entre la valeur dépréciée des biens ou le coût de réparation.
 b. Le moindre coût entre: 0,30\$ par livre par morceau, 50,00\$ par morceau ou 1000,00\$ par circonstance.
 GES Canada Ltée ne vend, ni offre des assurances. GES Canada Ltée n'est pas responsable si la perte ou le bris n'est pas causé par GES Canada Ltée.
GES Canada Ltd Limits of Liability
 ● **Liability** - GES Canada Ltd. is liable for loss or damage to your goods ONLY if the loss or damage was caused by GES Canada Ltd negligence.
 ● **Measure of Damage** - If GES Canada Ltd. was negligent and the negligence caused either loss or damage to your goods, then the measure of that damage will be determined by the following:
 a. Measure of damages in all situations (including b. below) will be limited by the Depreciated Value of the goods or repair costs, whichever is less.
 b. The lesser of \$0.30 per pound per piece, \$50 per piece, or \$1000 per occurrence.
 GES Canada Ltd does not offer or sell insurance. GES Canada Ltd. is not liable and will not owe for loss or damage to your goods if the damage was not caused by GES Canada Ltd.

Toutes les commandes sont soumises aux politiques de paiement et aux limites de responsabilité de GES Canada Ltée stipulées dans ce manuel de l'exposant.
 All orders are governed by the GES Canada Ltd Payment Policy and Limits of Liability & Responsibility as specified in this Exhibitor Kit.
 INDEMNITÉ D'ANNULATION: Après le début du montage de salon, toute annulation sera facturée à 50% du coût original et à 100% après la livraison.
 CANCELLATION CLAUSE: Items cancelled after move-in begins will be charged at 50% of the original price and 100% after installation.

Montant / Amount	\$
104060264 - TPS 5% GST	\$
1001673382 - TVQ 9.975% QST	\$
TOTAL	\$
Compagnie / Company	STAND #

**PLACE
BONAVENTURE**

ACCÈS AU DÉBARCADÈRE

Angle des rues St-Jacques et Montfort
Montréal QC

Aucune marchandise ne sera acceptée avant la date officielle de montage

LOADING DOCK ACCESS

Corner of St-Jacques & Montfort Streets
Montreal QC

No merchandise will be accepted prior to official move-in date.

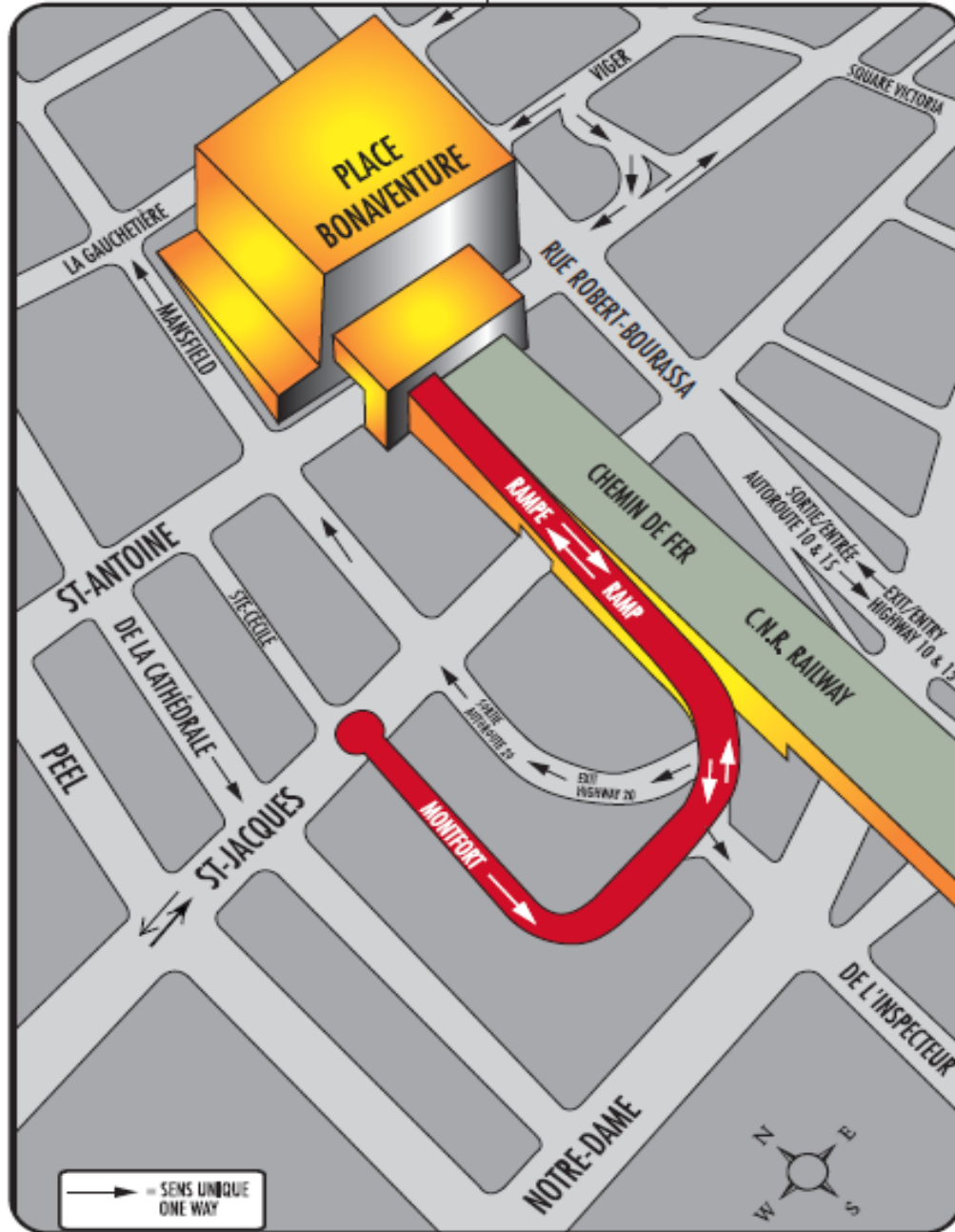



Terms & Conditions of Contract and Limits of Liability & Responsibility

I. Definitions:

Agents: GES Canada Ltd' agents, sub-contractors, carriers, and the agents of each.
Customer: Exhibitor or other party requesting services from GES Canada Ltd
Carrier: Motor carrier, van line, air carrier, or air or surface carrier/ freight forwarder.
Shipper: Party who tenders Goods to Carrier for transportation.
Goods: Exhibits, property, and commodities of any type for which GES Global Experience Specialists is requested to perform services.
Cold Storage: Holding of Goods in a climate controlled area.
Accessible Storage: Holding of Goods in an area from which Goods may be removed during shows.
Services: Warehousing, transportation, drayage, un-supervised labour, supervised labour and/or related services.
Show Site: The venue or place where an exposition or event takes place.
Supervised Labour: Labour that is provided to a Customer to install or dismantle a booth or exhibit space, and is supervised and/or directed by GES Canada Ltd.
Un-Supervised Labour: Labour that is provided to a Customer to install or dismantle a booth or exhibit space and per Customer's election is not supervised and/or directed by GES Canada Ltd Customer assumes the responsibility for the work of labour when Customer elects to use unsupervised labour.

II. Scope:

These Terms and Conditions shall be binding upon Customer, GES Canada Ltd. and their respective Agents and representatives, including but not limited to Customer contracted labour such as Customer Appointed Contractors and Installation and Dismantle Companies, and any other party with an interest in the Goods. Each shall have the benefit of and be bound by all provisions stated herein, including but not limited to time limits and limitations of liability.

By acceptance of services of GES Canada Ltd. or Agents, Customer and any other party with an interest in the Goods agree to these Terms and Conditions.

III. Customer Obligations:

Payment for Services. Customer shall be liable for all unpaid charges for services performed by GES Canada Ltd. or Agents. Customer authorizes GES Canada Ltd. to charge it's credit card directly for services rendered on it's behalf after departure, by placing an order on-line, via fax, phone, or through a work order on site.

Credit Terms. All charges are due before Services are performed unless other arrangements have been made in advance. GES Canada Ltd. has the right to require prepayment or guarantee of the charges at the time of request for Services. A failure to pay timely will result in Customer having to pay in cash in advance for future services. If a credit card is provided to GES Canada Ltd. , GES Canada Ltd. is authorized to bill to such credit card any unpaid charges for services provided Customer, including charges for return shipping. Any charges not paid within 30 days of delivery will be subject to interest at 1.5% per month until paid.

IV. Mutual Obligations:

Indemnification:

Customer to GES Canada Ltd. : Except to the extent of GES Canada Ltd.'s own negligence and/or willful misconduct, Customer shall defend, hold harmless and indemnify GES Canada Ltd. from and against any claims, lawsuits, demands, liability, costs, and expenses, including reasonable attorney's fees and court costs, resulting from any injury to or death of persons, or damage to property, relating to or arising from performance under this Agreement.

Customer agrees to indemnify and hold GES Canada Ltd. harmless for any and all acts of its representatives and agents, including but not limited to Customer Appointed Contractors and Installation and Dismantle Companies, any subtenant or other user of its' space or any agents or employees engaged in business on its' behalf of Customer or present at Customers' invitation.

GES Canada Ltd. to Customer: To the extent of GES Canada Ltd. own negligence and/or willful misconduct, and subject to the limitations of liability below, GES Canada Ltd. shall defend, hold harmless and indemnify Customer from and against any claims, lawsuits, demands, liability, costs and expenses, including reasonable attorney's fees and court costs, resulting from any injury to or death of persons, or damage to property other than Goods. GES Canada Ltd. assumes no liability for bodily injury resulting from Customer's presence in areas which have been marked as "off limits to exhibitors" and during hours and days when exhibitors are present in the facility, prior to the start of and after the conclusion of their space lease with show management.

V. No liability for consequential damages. UNDER NO CIRCUMSTANCES WILL ANY PARTY BE LIABLE FOR SPECIAL, INCIDENTAL, CONSEQUENTIAL OR PUNITIVE DAMAGES, INCLUDING BUT NOT LIMITED TO LOSS OF PROFITS OR INCOME.

VI. GES Canada Ltd. Liability for Loss or Damage to Goods

Negligence standard: GES Canada Ltd. shall be liable, subject to the limitations contained herein, for loss or damage to Goods only if such loss or damage is caused by the direct negligence or willful misconduct of GES Canada Ltd .

Condition of Goods: GES Canada Ltd. shall not be liable for damage, loss, or delay to uncrated freight, freight improperly packed, glass breakage or concealed damage. GES Canada Ltd. shall not be liable for ordinary wear and tear in handling of Goods or for damage to shrink wrapped Goods. All Goods should be able to withstand handling by heavy equipment, including but not limited to forklifts, cranes, or dollies. It is the Customers' responsibility to ensure that Goods are packaged correctly prior to shipment or movement on or off the Show floor.

Receipt of Goods: GES Canada Ltd. shall not be liable for Goods received without receipts, freight bills, or specified unit counts on receipts or freight bills. Such Goods shall be delivered to booth without the guarantee of piece count or condition.

Force Majeure: GES Canada Ltd. shall not be liable for loss or damage that results from Acts of God, weather conditions, act or default of Customer, shipper, or the owner of the Goods, inherent nature of the Goods, public enemy, public authority, labour disputes, and acts of terrorism or war.

Cold Storage: Goods requiring cold storage are stored at Customer's own risk. GES Canada Ltd. assumes no liability or responsibility for Cold Storage.

Accessible Storage: GES Canada Ltd. assumes no liability for loss or damage to Goods while in Accessible Storage. Storage charges are for the use of space and are not a form of insurance, or a guarantee of security.

Unattended Goods: GES Canada Ltd. assumes no liability for loss or damage to unattended Goods received at Show Site at any time from the point of receipt of inbound Goods until the loading of the outbound Goods, including the entire term of the respective show or exhibition. Customer is responsible for insuring it's own Goods for any and all risk of loss.

Labour: GES Canada Ltd. assumes no liability for loss, damage, or bodily injury arising out of Customer's supervision of GES Canada Ltd. provided labour. If GES Canada Ltd. supervises labour for a fee, GES Canada Ltd. shall be liable only for actions or claims arising out of its' negligent supervision. If Customer elects to use unsupervised labour, then Customer assumes all liability for the actions or claims that arise out of such work, and shall provide GES Canada Ltd. and show management with an indemnity, including defense costs, for any claims that result from Customers' supervision or failure to supervise assigned labour.



Terms & Conditions of Contract and Limits of Liability & Responsibility

Empty Storage: GES Canada Ltd. assumes no liability for loss or damage to Goods or crates, or the contents therein, while containers are in storage. It is the Customer's sole responsibility to affix the appropriate labels available at the GES Canada Ltd. Servicentre for empty container storage. Damage that is the direct result of GES Canada Ltd.'s negligence shall be subject to the limitations of liability set forth in this document.

Forced Freight: GES Canada Ltd. shall not be liable for Goods not picked up by Customer's chosen carrier by the show deadline. It is the Customer's responsibility to complete accurate paperwork for shipping and ensure its' Goods are appropriately labeled. Customer acknowledges that it is a lessee of space, and as such has an obligation to remove its' Goods on or before the targeted time. If Goods remain on the floor after this point, GES Canada Ltd has the right to remove them in order to restore the premises to its original condition for show management pursuant to the venue's lease with show management. In such cases GES Canada Ltd. is authorized to proceed in the manner chosen by the Customer on the Order for Material Handling Services/ Straight Bill of Lading. Failure to select one of the provided options will result in re-routing at GES Canada Ltd' discretion, and at Customer's expense assuming the Goods are labeled for return. GES Canada Ltd. retains the right to dispose of Goods left on the show floor without liability if left unattended, left without labels or not correctly labeled.

Concealed Damage: GES Canada Ltd. shall not be liable for concealed loss or damage, uncrated Goods, or improperly package or labeled Goods.

Unattended Booth: GES Canada Ltd. shall not be liable for any loss or damage occurring while Goods are unattended in Customer's booth at any time, including, but not limited to, the time the Goods are delivered to the dock until the time the Goods are received by Customer's chosen carrier. All Material Handling Forms and/or Straight Bills of Lading covering outgoing Goods submitted to GES Canada Ltd. will be checked at the time of pickup from the booth and corrections to the count or condition will be documented where discrepancies exist.

Measure of Damage: GES Canada Ltd. liability shall be limited to the lesser of 1) the depreciated value of Goods, 2) repair cost, or 3) the limitation of liability. The limitation of liability shall be \$0.30 (thirty cents) per pound per piece, \$50 (fifty dollars) per article or \$1000.00 (one thousand dollars) per shipment.

No Insurance: GES Canada Ltd. is not an insurance company and does not offer or provide insurance. It is the obligation of Customer to ensure Goods are insured at all times. Loss or theft of the Goods in storage or in transit to and from the show and or while on the show floor is the sole responsibility of Customer, unless it is shown that GES Canada Ltd. performed in a manner that constitutes gross negligence in the performance of its services for Customer.

Notice of loss or damage: In order to have a valid claim, notice of loss or damage to Goods must be given to GES Canada Ltd. within 24 hours of occurrence or delivery of Goods, whichever is later.

Filing of Claim: Any claim for loss or damage to Goods must be in writing, containing facts sufficient to identify the Goods, asserting liability for alleged loss or damage, and making claim for the payment of a specified or determinable amount of money. Such claim must be filed with the appropriate party within the time limits specified below.

Damage Reports, incident reports, inspection reports, notations of shortage or damage on freight bills or other documents, do not constitute filing of a claim.

Claim for goods alleged to be lost, stolen or damaged at the Show Site must be received in writing by GES Canada Ltd. within sixty (60) days after the close of the show.

Claims for Goods alleged to be lost or damaged during transit must be received by the responsible party within nine (9) months of the date of delivery of Goods. GES Canada Ltd. Logistics subcontracts the movement of Goods to third party carriers. Claims for damage in transit should be made directly with the Customer's carrier as shown on the Material Handling form / Straight Bill of Lading. In the event of a dispute with GES Canada Ltd., Customer will not withhold payment or any amount due GES Canada Ltd. for Services as an offset against the amount of the alleged loss or damage. Customer agrees to pay GES Canada Ltd. prior to the close of the show for all such charges and further agrees that any claim Customer may have against GES Canada Ltd. shall be pursued independently by Customer as a separate action to be resolved on its own merits. GES Canada Ltd. reserves the right to pursue collection on amounts owed after show close, without regard to any amount alleged to be owed for damage, or loss.

Filing of Suit: Any action at law regarding loss or damage to Goods must be filed within one (1) year of the date of declination of any part of a claim.

VII. Jurisdiction, Choice of Forum.

This Agreement shall be governed by and construed in accordance with the applicable laws of Canada or, alternatively, and depending on jurisdiction, the laws of the Province of Quebec.

VIII. Advance Warehousing / Temporary Storage / Long Term Storage.

All terms and conditions relative to Advanced Warehousing / Temporary Storage / Long Term Storage are contained in the separate agreement entitled "Storage Agreement". In the event that a Storage Agreement is not executed between the parties, the following shall apply with respect to GES' liability for Customer's Goods: The responsibility of GES Canada Ltd. with respect to Exhibit Material is limited to the exercise of ordinary care and diligence in handling and storing of Customer's Goods. GES Canada Ltd shall be liable only for loss or damage to Goods caused by GES Canada Ltd sole negligence. GES Canada Ltd.' liability is limited to sixty (\$0.60) cents per pound or the actual cash value per article. In the case of partial loss or damage, the maximum liability shall be prorated based on weight. GES Canada Ltd. is not responsible for any loss or damage to Goods caused by, but not limited to fire, theft, the elements, vandalism, moisture, vermin, mechanical breakdown or failure, freezing or changes in temperature, as well as any other causes beyond GES Canada Ltd.' immediate control. GES Canada Ltd. is not responsible for the marring, scratching, or breakage of glass or other fragile items. GES Canada Ltd. is not liable for the mechanical functions of instruments or appliances even if such articles are packed or unpacked by GES Canada Ltd. In no event shall GES Canada Ltd. be liable for special, incidental, indirect, or consequential damages, including business loss of any kind, resulting from any damage to or loss of Goods or from any act or failure to act. Customer pays storage fees, if any or costs for advance warehousing for use of the space only. There is no guarantee of security or representations made by GES Canada Ltd. as to appropriateness of the conditions for Exhibitors' Material. This risk of loss remains the Customer's alone and GES Canada Ltd. recommends the Customer carry and maintain insurance in amounts sufficient to cover its risk.

SPECIAL NOTE: THE CONSIGNMENT OR DELIVERY OF A SHIPMENT TO GES CANADA LTD OR ITS SUBCONTRACTORS BY A CUSTOMER OR BY ANY SHIPPER ON BEHALF OF THE CUSTOMER SHALL BE CONSTRUED AS AN ACCEPTANCE BY SUCH EXHIBITOR (AND/OR OTHER SHIPPER) OF THE TERMS AND CONDITIONS SET FORTH IN THIS AGREEMENT.

La sécurité est très importante pour toutes les personnes qui travaillent dans la salle d'exposition – surtout la vôtre !

GES Canada Ltée est engagé à la sécurité au niveau de la compagnie et à travers les fonctions que nous effectuons. Nous vous demandons de prioriser la sécurité lors de vos activités pendant l'évènement. Si vous êtes témoin d'une action qui représente un danger, veuillez s.v.p. la rapporter à un superviseur de GES Canada Ltée. En témoignant des actions non sécuritaires, vous aiderez à rendre l'évènement plus sécuritaire et agréable pour vous et vos confrères exposants.

Veuillez vous référer et respecter la liste des conseils de prévention de pertes que vous trouverez ci-dessous. Ces directives aideront à améliorer la sécurité de l'évènement en général et de prévenir des blessures aux exposants, aux employés et à vous. Amusez-vous et faites-le en toute sécurité ! Merci de votre collaboration !

Guide de conseils de prévention de perte pour les exposants sur le site de l'évènement.

- Il est strictement interdit de fumer dans le hall d'exposition.
- Il est INTERDIT de monter debout sur les chaises, tables ou tout autre mobilier. Veuillez utiliser une échelle ou demander de l'aide auprès du personnel de GES Canada Ltée.
- Seuls les employés autorisés de GES Canada Ltée ont l'autorisation d'opérer les chariots élévateurs ainsi que les transpalettes. Demandez de l'aide.
- Faites attention aux chariots élévateurs qui circulent dans les allées et sur les débarcadères. Veuillez s.v.p. vous tenir loin de ces appareils, surtout lorsqu'ils transportent une charge ou une palette.
- Ne jamais courir dans le hall d'exposition. S.V.P. veuillez marcher. Attention où vous mettez les pieds dans les allées et restez loin des débarcadères.
- Les fils électriques ainsi que les extensions peuvent être dangereux s'ils sont effilochés ou étirés dans une allée. S.V.P. veuillez vérifier l'état des fils. Pour toute assistance ou pour remplacer un fil endommagé, veuillez aviser le responsable des services électriques. Ne pas surcharger les prises électriques.
- S.V.P. veuillez garder les sorties de feu dégagées. Si vous êtes témoin d'un feu, veuillez le signaler immédiatement ou actionner l'alarme de feu le plus près.
- Si vous renversez quelque chose, ou apercevez un liquide renversé, veuillez le signaler immédiatement.
- Gardez votre espace propre. Jetez les débris et disposez votre matériel de façon sécuritaire.
- Les allées doivent rester propres et sans débris.
- Assurez-vous que vos effets de grande valeur sont placés dans un endroit sécuritaire dans le hall d'exposition. Les articles laissés sans supervision dans les kiosques peuvent être des cibles pour le vol.
- Si vous avez des préoccupations ou des questions par rapport à la sécurité, veuillez vous adresser à un représentant de GES Canada Ltée.

Safety is very important for everyone working in the exhibit hall - especially you!

GES Canada Ltd. is committed to safety throughout our company and in the work that we do. We request that you make safety a part of your activities during the show. If you see something unsafe or that presents a hazard, please bring it to the attention of a GES Canada Ltd. supervisor. By reporting unsafe or hazardous conditions, you will help make the show safer and more enjoyable for yourself and your fellow exhibitors.

Below you will find a list of Loss Prevention Guidelines that we request you follow while at showsite. These Guidelines will enhance the overall safety of the show and help to prevent injuries to you, our employees, and other exhibitors. Enjoy the show and do it safely. Thank you for your Cooperation!

Exhibitor loss prevention guidelines at showsite

- Smoking is prohibited in the exhibit venue.
- Standing on chairs, tables, and other furniture is PROHIBITED. The furniture is not designed to support your standing weight. Please use a ladder or ask GES Canada Ltd. personnel for assistance.
- Forklifts and pallet jacks are to be used by authorized GES Canada Ltd. personnel only. Please do not operate this equipment. Ask for help.
- Be aware of the forklifts moving throughout the aisles and docks. Please stay clear of them, especially when they are carrying a crate or a load.
- Never run in the exhibit hall. Please walk. Watch your step in the aisles and stay away from the loading docks.
- Electrical wires and cords can be hazardous if frayed or stretched over a walkway. Please check all cords for damage. Notify the electrical service company if you need assistance repairing or removing a damaged cord. Do not overload outlets or plugs.
- Please keep fire exits clear. Report any fires immediately or pull the nearest fire alarm.
- If you spill something, or notice a spill, clean it up or report it immediately. Please do not walk away from a spill.
- Use good housekeeping. Dispose of waste properly and keep materials stacked securely.
- Keep aisles free and clear of any and all debris.
- Protect your valuables while on the show floor. Please keep all expensive or valuable items secured. Unattended items in booths are easy theft targets.
- Notify a GES Canada Ltd representative of any safety issues or concerns.