

**GES** is pleased to have been selected the official service contractor by the Show Organizer to design and produce your show. Our goal is to ensure your show participation is a success.

**GES** is involved in many areas relative to the show and if at any time during the planning process you are unsure where to turn, just ask us, we are at your service.

Please ensure that you review this section carefully as it contains information, **DISCOUNT PRICES** and order forms for each of the many services being provided by **GES**.

For your convenience, we will be offering the following services:

- ✓ Online Ordering
- ✓ Furnishings
- ✓ Carpet & Underpadding
- ✓ GEM Exhibits & Accessories
- ✓ Signs & Graphics
- ✓ Installation & Dismantling Labour
- ✓ In-Booth Forklift

To take advantage of our **DISCOUNT PRICING**, all order forms and full payment must be received on or before the Discount Date of January 26 as indicated on each form. **GES** accepts Visa, Mastercard, American Express, Cheques and Cash as methods of payment for our services. All exhibitors are responsible for payment of G.S.T. when exhibiting in Alberta.

If you need assistance or additional information, please contact our **Exhibitor Services Department at (403) 243-2212.**



## Accelerate your experience with Expresso exhibit planning, ordering and management.

Exhibitors can order everything they need for their tradeshow exhibit through Expresso, our simple to navigate, picture-driven system that satisfies your need for speed. With just a few clicks exhibitors can order GES products and services including:

- Booth furniture.
- Carpet and flooring.
- Material handling.
- Booth labour.
- And much more.

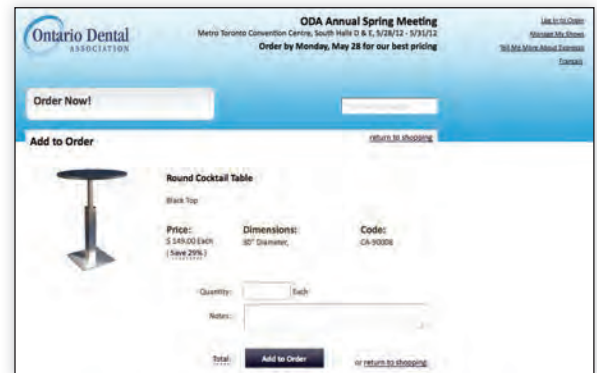

**Expresso is more than just an online exhibitor manual. Exhibitors can:**

- Order exhibit products and services.
- Print shipping labels.
- View important show and event information.
- Download the show schedule into Outlook or iCalendar.
- View account order status and history.



**Experience a difference with Expresso.**

- Each show has their own custom website.
- Runs on all browsers for PCs, Macs and tablets.
- Everything in one place; all organizer and show information, ordering and even third party forms.
- Keeps you on-time and on-budget.



#25, 5805 - 76 Ave. SE Calgary, Alberta, T2C 5L8 Tel: (403) 243-2212 Fax: (403) 243-3868 Toll Free 1-800-636-8235 www.gesexpo.ca

SHOW: 2017 Calgary Boat & Sportsmen's Show

**EXHIBITOR INFORMATION**

BOOTH #: \_\_\_\_\_

COMPANY \_\_\_\_\_

STREET \_\_\_\_\_

CITY \_\_\_\_\_ PROV/STATE \_\_\_\_\_ CODE \_\_\_\_\_

E-MAIL \_\_\_\_\_

PHONE \_\_\_\_\_ FAX \_\_\_\_\_

CONTACT NAME \_\_\_\_\_

**IMPORTANT - READ CAREFULLY**

Please fill out The Credit Card Authorization below if:

- You or your company are forwarding payment to GES in the form of a cheque.
- There is any possibility you or your representative will be ordering any service on-site.
- You are ordering Material Handling, Installation and Dismantle Labour or In-Booth Forklift Services.

**PLEASE COMPLETE THE FOLLOWING**

MASTERCARD   
  VISA   
  AMERICAN EXPRESS   
 EXPIRY DATE:

CORPORATE   
  PERSONAL

**CARD #**

CARDHOLDER'S NAME (PRINT): \_\_\_\_\_

CARDHOLDER'S SIGNATURE: \_\_\_\_\_

Cardholder's Billing Address: \_\_\_\_\_

City: \_\_\_\_\_ Prov/State: \_\_\_\_\_ Code/Zip: \_\_\_\_\_

Tel: \_\_\_\_\_ Fax: \_\_\_\_\_

This authorization allows GES to charge any fees outstanding after show closing to this credit card (including funds owed due to a cheque returned NSF)

**CHEQUES WILL NOT BE ACCEPTED WITHOUT THIS CREDIT CARD AUTHORIZATION**

**IF THIS AUTHORIZATION IS NOT COMPLETED, ALL ON-SITE ORDERS ARE EXPECTED TO BE PAID IN FULL BEFORE DELIVERY**

TO: **GES**  
FAX: **(403) 243-3868**  
DATE: \_\_\_\_\_  
FROM: \_\_\_\_\_  
SHOW NAME: \_\_\_\_\_  
COMPANY: \_\_\_\_\_  
BOOTH #: \_\_\_\_\_

✓ To help us ensure we have received your entire order, please check off those forms you are sending us:

- Third Party Billing
- Credit Card Authorization
- Furnishings
- Carpet & Underpadding
- Exhibit Accessories
- Signs
- Installation & Dismantle Labour Services

***Please call to confirm receipt of your order.***

***To receive Discount Pricing send your order in  
by the Discount Price Deadline Date - January 26, 2017***

***Thank you from GES***





**DISCOUNT PRICING:**

To qualify for **Discount Pricing**, orders must be received **with payment in full on or before the deadline date.** Late orders will be charged the **Regular Prices.** Orders without payment cannot be processed until payment is received and could be charged the **Regular Price.**

**METHOD OF PAYMENT:**

GES accepts American Express, MasterCard, Visa, Debit Card, Cheque and Bank Wire Transfers. Purchase Orders are not considered payment. **Exhibitors will be charged a \$25.00 fee for returned NSF cheques.**

**BANK WIRE TRANSFER INFORMATION:**

To properly credit your account, please complete the **BANK WIRE TRANSFER FORM** included with the GES order forms and send the following information to the GES Exposition Services (Canada) Limited address listed on the Bank Wire Transfer Form.

***NOTE: There is a minimum \$20.00 Service Charge (North America) \$40.00 (International) applicable on all wire transfers. Fees vary depending on banks processing wire transfers.***

**PAYMENT SCHEDULE:**

Payment for all services must be pre-paid in full. GES will not provide Material Handling, In-Booth Forklifts, or Installation and Dismantle Labour Services without your company's **CREDIT CARD AUTHORIZATION FORM** on file.

**THIRD PARTY BILLING:**

You may arrange for an exhibit house or other agent to manage your exhibit & order services on your behalf. GES will agree to this arrangement if the exhibit house or agent makes satisfactory payment arrangements with us. In the event the authorized Third Party does not pay, each exhibiting company is ultimately responsible for all charges incurred on its behalf. See **THIRD PARTY BILLING REQUEST FORM.**

**ADJUSTMENTS AND CANCELLATIONS:**

Adjustments to your invoice **will not be made after the close of the show.** Some items, services and labour are subject to cancellation fees. Refer to each order form for details.

**ALL EXHIBITORS MUST PAY 5% GST ON ALL ORDERS.**



**ELECTRONIC FUNDS/WIRE  
TRANSFER FORM**

5675 McLaughlin Road, Mississauga, Ontario, L5R 3K5 Phone: 905-283-0500 Fax: 905-283-0501

**Please complete and return this form to : Jolanta Baloniak, Accounts Receivable  
GES Exposition Services (Canada) Limited  
Email: ar@ges.com Fax: 905-283-0501**

**Your Company Name:** \_\_\_\_\_  
**Contact Name:** \_\_\_\_\_  
**Contact Number:** \_\_\_\_\_  
**Booth Number:** \_\_\_\_\_ **Event Name:** 2017 Calgary Boat & Sportsmens Show

**GES BANK INFORMATION**

PLEASE INCLUDE ALL OF THE FOLLOWING INFORMATION TO ENSURE YOUR FUNDS REACH OUR BANK

**Account Name:** GES Exposition Services (Canada) Limited  
**Bank Name:** Bank of Montreal  
**Address:** 350-7th Avenue SW  
Calgary, AB  
T2P 3N9

\*IF YOU ARE SENDING CANADIAN DOLLARS

\*IF YOU ARE SENDING AMERICAN DOLLARS

**EFT/Direct Deposit**

Institution code #: 001  
Transit #: 00109  
Account #: 1967-990

Institution code #: 001  
Transit #: 00109  
Account #: 4773-410

**Wire Transfers**

Account #: 1967-990  
Beneficiary's Bank: //CC000100109  
Swift Code: BOFMCAM2

Account #: 4773-410  
Beneficiary's Bank: //CC000100109  
Intermediary Bank: Wells Fargo Bank (FKA Wachovia)  
Swift Code: PNBPUS3NNYC

**Routing / BIC / NCC / BSC or ABA Number:** 026005092

**Invoice Amount:** \_\_\_\_\_

**Date of Transfer:** \_\_\_\_\_

**\*Minimum Bank Charge:** \$20.00 (North American) \$40.00 (International)

**Total:** \_\_\_\_\_

**Please Note:** Ensure transfer is made a minimum of 10 days prior to the show move in date.  
\*Minimum Bank Charges as shown above, reflect GES's bank charges only.  
Any additional wire transfer and EFT fees are the exhibitor's responsibility.





# furnishings

Grey Fabric Side Chair



Grey Fabric Counter Stool



Grey Fabric Arm Chair



Steno Chair



30" Round / 30" High Pedestal Table



30" Round / 18" High Coffee Table



4', 6', OR 8' Long Raised Draped Table with White Vinyl Top



4', 6', OR 8' Long Draped Table with White Vinyl Top





# furnishings

Coat Tree



22" W X 28" H  
Chrome Sign Holder  
(sign extra)

Easel



Gold Ballot Drum



Plexi Pocket



40" W x 20" D x 36" H  
White Counter Storage Unit



Bag Holder 41"H



Stanchions  
6" Belt



Plastic  
Wastebasket



#25, 5805 - 76 Ave. SE Calgary, Alberta, T2C 5L8 Tel: (403) 243-2212 Fax: (403) 243-3868 Toll Free 1-800-636-8235 www.gesexpo.ca

SHOW: 2017 Calgary Boat & Sportsmen's Show

**DISCOUNT PRICE  
DEADLINE DATE:**

January 26, 2017

**EXHIBITOR INFORMATION**

**BOOTH #:** \_\_\_\_\_

COMPANY \_\_\_\_\_

STREET \_\_\_\_\_

CITY \_\_\_\_\_ PROV/STATE \_\_\_\_\_ CODE \_\_\_\_\_

E-MAIL \_\_\_\_\_

PHONE \_\_\_\_\_ FAX \_\_\_\_\_

CONTACT NAME \_\_\_\_\_

**CREDIT CARD AUTHORIZATION**

MASTERCARD  VISA  AMEX

--	--	--	--	--	--	--	--	--	--

EXPIRY DATE \_\_\_\_\_ / \_\_\_\_\_

CARDHOLDER NAME \_\_\_\_\_

CARDHOLDER SIGNATURE \_\_\_\_\_

CHEQUE ATTACHED (PAYABLE TO GES)

**ALL ORDERS MUST BE PREPAID IN FULL  
(ORDERS CANNOT BE PROCESSED UNTIL PAYMENT IS RECEIVED)**

FURNISHINGS				
QTY	DESCRIPTION	DISCOUNT PRICE	REGULAR PRICE	TOTAL
	Grey Fabric Side Chair	\$41.00	\$57.00	
	Grey Fabric Counter Stool	\$89.50	\$125.50	
	Grey Fabric Arm Chair	\$42.00	\$74.50	
	Steno Chair	\$58.00	\$81.00	
	Cocktail Table 40" High	\$90.00	\$125.50	
	30" Round 30" High Pedestal Table	\$74.50	\$104.50	
	30" Round 18" High Coffee Table	\$57.00	\$79.50	
	Coat Tree	\$32.00	\$45.00	
	22" x 28" Chrome Sign Holder (Sign Extra)	\$48.50	\$68.00	
	Easel	\$41.00	\$57.50	
	Ballot Drum	\$65.00	\$91.00	
	Garment Rack on Wheels	\$46.50	\$65.00	
	White Counter Storage Unit 40" H	\$139.50	\$195.50	
	Bag Holder 41"H	\$68.00	\$95.50	
	Tape Stanchion	\$43.50	\$60.50	
	Wastebasket	\$22.50	\$32.00	

**DRAPED DISPLAY TABLES 30" HIGH**

BLACK  BLUE  BURGUNDY  GREEN  RED  SILVER  WHITE

QTY	DESCRIPTION	DISCOUNT PRICE	REGULAR PRICE	TOTAL
	4 Ft. Long x 2 Ft. Wide	\$85.50	\$119.50	
	6 Ft. Long x 2 Ft. Wide	\$94.00	\$131.50	
	8 Ft. Long x 2 Ft. Wide	\$101.50	\$142.50	
	Drape Fourth Side	Add \$37.00 ea.		

**RAISED DRAPED DISPLAY TABLES 42" HIGH**

BLACK  BLUE  SILVER  WHITE

QTY	DESCRIPTION	DISCOUNT PRICE	REGULAR PRICE	TOTAL
	4 Ft. Long x 2 Ft. Wide	\$97.50	\$136.50	
	6 Ft. Long x 2 Ft. Wide	\$120.00	\$168.00	
	8 Ft. Long x 2 Ft. Wide	\$147.00	\$206.00	
	Drape Fourth Side	Add \$37.00 ea.		

**CUSTOM BOOTH DRAPING**

BLACK  BLUE  RED  SILVER  WHITE

	3 Ft. High (Per Linear Ft.)	\$7.00	\$10.00	
	8 Ft. High (Per Linear Ft.)	\$8.00	\$11.00	

**Terms & Conditions**

- All orders received after the Discount Price Date will be processed at the Regular Price.
- Exhibitor is responsible for all items for the duration of the show.
- If a colour is not chosen, GES will choose a colour for you.
- Charges are for rental of equipment only. All items remain the property of GES.
- GES is not responsible for exhibit materials left in GEM rental exhibits or counter storage units.
- All claims or discrepancies must be settled at the GES Service Centre prior to show closing.
- No refunds/exchanges on cancelled draped tables or custom booth draping once delivered. 50% refund on furnishings cancelled prior to show opening.

<b>SUBTOTAL</b>	
<b>5% GST</b>	
<b>TOTAL</b>	
GES #R104060264	

**I have read and understand the Terms & Conditions of my Agreement with GES.**

\_\_\_\_\_  
Signature

\_\_\_\_\_  
Date

# CARPET ORDER FORM

#25, 5805 - 76 Ave. SE Calgary, Alberta, T2C 5L8 Tel: (403) 243-2212 Fax: (403) 243-3868 Toll Free 1-800-636-8235 www.gesexpo.ca

SHOW: 2017 Calgary Boat & Sportsmen's Show

**EXHIBITOR INFORMATION**

BOOTH #: \_\_\_\_\_

COMPANY \_\_\_\_\_

STREET \_\_\_\_\_

CITY \_\_\_\_\_ PROV/STATE \_\_\_\_\_ CODE \_\_\_\_\_

E-MAIL \_\_\_\_\_

PHONE \_\_\_\_\_ FAX \_\_\_\_\_

CONTACT NAME \_\_\_\_\_

**DISCOUNT PRICE DEADLINE DATE:** January 26, 2017

**CREDIT CARD AUTHORIZATION**

MASTERCARD   
  VISA   
  AMEX

--	--	--	--	--	--	--	--

EXPIRY DATE \_\_\_\_ / \_\_\_\_

CARDHOLDER NAME \_\_\_\_\_

CARDHOLDER SIGNATURE \_\_\_\_\_

CHEQUE ATTACHED (PAYABLE TO GES)

**ALL ORDERS MUST BE PREPAID IN FULL  
(ORDERS CAN NOT BE PROCESSED UNTIL PAYMENT IS RECEIVED)**

**BOOTH CARPET - STANDARD SIZE**  
*Note: Exhibitors ordering multiple pieces of carpet in this section may not receive the same dyelot.*

QTY.	DESCRIPTION	DISCOUNT PRICE	REGULAR PRICE	TOTAL
	10 Ft. X 10 Ft. Single Booth	\$161.00	\$225.00	
	10 Ft. X 20 Ft. Double Booth	\$322.50	\$451.00	

**COLOUR SELECTION:**   
 BLACK   
 BLUE   
 GREY   
 RED

**BOOTH CARPET - CUSTOM SIZE**  
*If your booth requires a size not listed above, please complete this section.*

BOOTH SIZE: ____ Ft. x ____ Ft. = ____ Sq. Ft.	\$1.61/Sq. Ft.	\$2.26/Sq. Ft.	
--	----------------	----------------	--

**COLOUR SELECTION:**   
 BLACK   
 BLUE   
 GREY   
 RED

**UNDERPADDING PRICE PER SQUARE FOOT INSTALLED (100 SQ. FT. MIN.)**

BOOTH SIZE: ____ Ft. x ____ Ft. = ____ Sq. Ft.	\$1.08/Sq. Ft.	\$1.51/Sq. Ft.	
--	----------------	----------------	--

**PROTECTIVE PLASTIC COVERING PRICE PER SQUARE FOOT INSTALLED (STANDARD SIZES ONLY)**

BOOTH SIZE: ____ Ft. x ____ Ft. = ____ Sq. Ft.	\$0.24/Sq. Ft.	\$0.33/Sq. Ft.	
--	----------------	----------------	--

PLEASE SELECT ONE FOR CUSTOM CARPET SIZES ONLY

IF ORDERING ELECTRICAL OR TELECOMMUNICATIONS SERVICES, WILL UNDER CARPET WIRING BE REQUIRED?

YES     NO

**Terms & Conditions**

- All orders received after the Discount Price Date will be processed at the Regular Price.
- Exhibitor is responsible for all items for the duration of the show.
- No refunds/exchanges on carpets once delivered.
- Charges are for rental of equipment only. All items remain the property of GES.
- All claims or discrepancies must be settled at the GES Service Centre prior to show closing.
- If a colour is not chosen, GES will choose a colour for you. *Carpet colour subject to availability.*

<b>SUBTOTAL</b>	
<b>5% GST</b>	
<b>TOTAL</b>	
GST #R104060264	

**I have read and understand the Terms & Conditions of my Agreement with GES.**

\_\_\_\_\_

**Signature**

\_\_\_\_\_

**Date**



#25, 5805 - 76 Ave. SE Calgary, Alberta, T2C 5L8 Tel: (403) 243-2212 Fax: (403) 243-3868 Toll Free 1-800-636-8235 www.gesexpo.ca

SHOW: 2017 Calgary Boat & Sportsmen's Show	<b>DISCOUNT PRICE DEADLINE DATE:</b> January 26, 2017				
<b>EXHIBITOR INFORMATION</b>	<b>CREDIT CARD AUTHORIZATION</b>				
BOOTH #: _____	<input type="checkbox"/> MASTERCARD <input type="checkbox"/> VISA <input type="checkbox"/> AMEX				
COMPANY _____	<table border="1" style="width: 100%; height: 20px; border-collapse: collapse;"> <tr> <td style="width: 25%;"></td> <td style="width: 25%;"></td> <td style="width: 25%;"></td> <td style="width: 25%;"></td> </tr> </table>				
STREET _____	EXPIRY DATE _____ / _____				
CITY _____ PROV/STATE _____ CODE _____	CARDHOLDER NAME _____				
E-MAIL _____	CARDHOLDER SIGNATURE _____				
PHONE _____ FAX _____	<input type="checkbox"/> CHEQUE ATTACHED (PAYABLE TO GES)				
CONTACT NAME _____					

## ALL ORDERS MUST BE PREPAID IN FULL

(ORDERS CAN NOT BE PROCESSED UNTIL PAYMENT IS RECEIVED)

INITIAL CLEANING SERVICES	DAILY CLEANING SERVICES	ADDITIONAL CLEANING SERVICES
Performed evening prior to show opening  • Carpets vacuumed	Performed prior to show opening and every night at show close for duration of show  • Carpets vacuumed • Wastebaskets emptied	Performed upon request  • For carpet in need of special attention due to food sampling demonstrations, hair, wood, metal shavings, grease or paint.

RATES		RATES			RATES	
DISCOUNT PRICE	REGULAR PRICE	BOOTH SQUARE FOOT	DISCOUNT PRICE	REGULAR PRICE	DISCOUNT PRICE	REGULAR PRICE
\$0.40 / sq.ft.	\$0.56 / sq.ft.	50 - 600 sq.ft.	\$0.57/sq.ft.	\$0.80/sq.ft.	To Be Quoted	N/A
		601-1000 sq.ft.	\$0.48/sq.ft.	\$0.67/sq.ft.		
		OVER 1000sq.ft.	\$0.40/sq.ft.	\$0.56/sq.ft.		

**SELECT SERVICE REQUIRED:**

Initial Cleaning      \_\_\_\_\_ @ \_\_\_\_\_ = \_\_\_\_\_  
 Daily Cleaning      Total sq.ft.of Booth      \$ Per sq.ft.      Total  
 Additional Services

**Terms & Conditions**

- All orders received after the Discount Price Date will be processed at the Regular Price.
- No cancellations after move-in begins.
- All claims or discrepancies must be settled at the GES Service Centre prior to show closing.
- All orders are governed by GES Limits of Liability and Responsibility

<b>SUBTOTAL</b>	
<b>5% GST</b>	
<b>TOTAL</b>	
	GST #R104060264

**I have read and understand the Terms & Conditions of my Agreement with GES.**

\_\_\_\_\_  
Signature

\_\_\_\_\_  
Date

#25, 5805 - 76 Ave. SE Calgary, Alberta, T2C 5L8 Tel: (403) 243-2212 Fax: (403) 243-3868 Toll Free 1-800-636-8235 www.gesexpo.ca

SHOW: 2017 Calgary Boat & Sportsmen's Show	<b>DISCOUNT PRICE DEADLINE DATE:</b> January 26, 2017				
<b>EXHIBITOR INFORMATION</b>	<b>CREDIT CARD AUTHORIZATION</b>				
BOOTH #: _____	<input type="checkbox"/> MASTERCARD <input type="checkbox"/> VISA <input type="checkbox"/> AMEX				
COMPANY _____	<table border="1" style="width:100%; height: 20px; border-collapse: collapse;"> <tr> <td style="width: 25%;"> </td> <td style="width: 25%;"> </td> <td style="width: 25%;"> </td> <td style="width: 25%;"> </td> </tr> </table>				
STREET _____	EXPIRY DATE ____ / ____				
CITY _____ PROV/STATE _____ CODE _____	CARDHOLDER NAME _____				
E-MAIL _____	CARDHOLDER SIGNATURE _____				
PHONE _____ FAX _____	<input type="checkbox"/> CHEQUE ATTACHED (PAYABLE TO GES)				
CONTACT NAME _____					

# Show Special

→ Spend less
→ Sell More
→ Look great

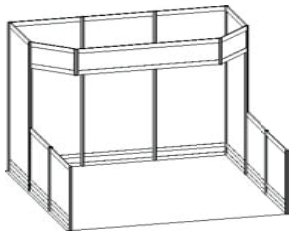

\$1000.50

**PACKAGE A: 10'x10' BOOTH**

- Header Sign - 12"x78"
- Infill Panels
- Colour Coordinated 10'x10' Carpet
- Price after Deadline Date: **\$1,400.50**

- ✓ Installed and Dismantled
- ✓ Ready before you arrive
- ✓ No Labour Costs
- ✓ No Trucking Costs
- ✓ No Material Handling Costs
- ✓ Includes Carpet
- ✓ Includes Header Sign(s)
- ✓ Choice of Colours
- ✓ Accessories Available

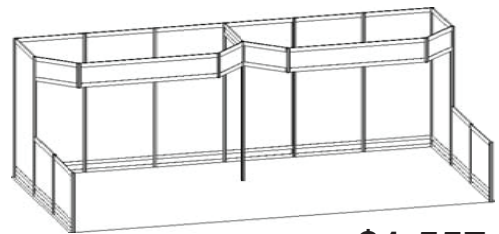

\$1,557.50

**PACKAGE B: 10'x20' BOOTH**

- 2 Header Signs - 12"x78" each
- Infill Panels
- Colour Coordinated 10'x20' Carpet
- Price after Deadline Date: **\$2,180.50**

Indicate Date and Time you plan to arrive to merchandise your exhibit: \_\_\_\_\_  
Date Time

<b>PLEASE COMPLETE THE FOLLOWING:</b>			
<b>SIZE ORDERED:</b>	<b>PACKAGE A:</b> <input type="checkbox"/> 10'x10'	<b>PACKAGE B:</b> <input type="checkbox"/> 10'x20'	
Infill Panel Colour: <b>White Only</b>			
Carpet Colour: <input type="checkbox"/> Black <input type="checkbox"/> Blue <input type="checkbox"/> Red <input type="checkbox"/> Grey			
<i>(All panel &amp; carpet colours subject to availability.)</i>			
Package A Identification Sign to Read: _____			
Package B Identification Sign to Read: Left: _____ Right: _____			
<input type="checkbox"/> <b>Custom Header to be added</b>			
Please e-mail artwork to: calgarygraphics@ges.com    Label e-mail with Exhibitor Name & Show Name/Date (file must be eps, ai, cdr)			
<b>Custom Header Signs/Logos will be charged \$100.00 extra per sign</b>			
<b>ALL ORDERS MUST BE PREPAID IN FULL</b>			
<b>(ORDERS CAN NOT BE PROCESSED UNTIL PAYMENT IS RECEIVED)</b>			

**Terms & Conditions**

- Does not include lighting or electrical service.
- No refunds/exchanges once show move-in begins.
- All claims or discrepancies must be settled prior to show closing.
- All orders received after the Discount Price Date will be processed at the Regular Price.
- GES is not responsible for exhibit materials left in GEM rental exhibits or counter storage units.

**I have read and understand the Terms & Conditions of my Agreement with GES.**

<b>SUBTOTAL</b>	
<b>5% GST</b>	
<b>TOTAL</b>	
	GST #R104060264

\_\_\_\_\_  
Signature

\_\_\_\_\_  
Date



# standard exhibit rentals

**10' X 10'**  
EXHIBITS

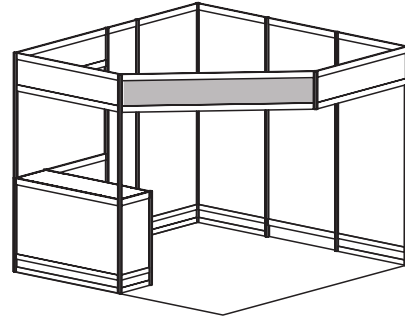

● GEM Model #1 - 10'x10' Corner

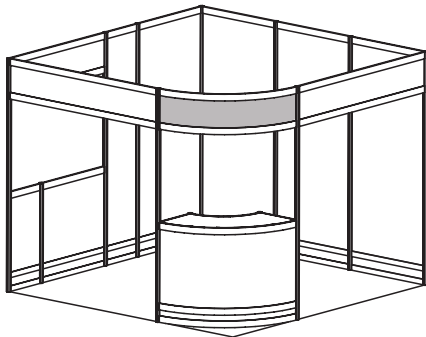

● GEM Model #2 - 10'x10' Corner

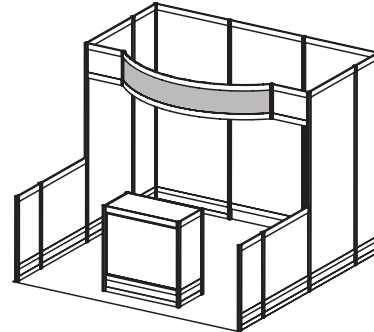

● GEM Model #3 - 10'x10'

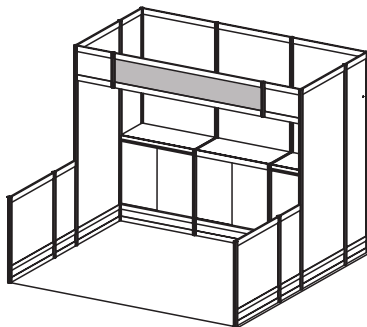

● GEM Model #4 - 10'x10'

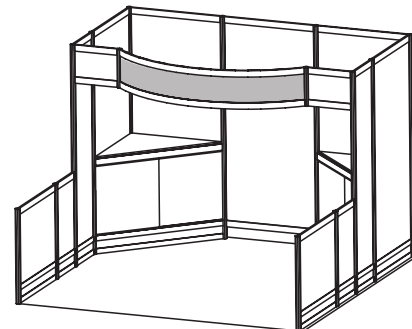

● GEM Model #5 - 10'x10'

## 3 Easy Steps

- 1 Select the model number that suits your needs
- 2 Choose carpet and panel colours on the GEM Exhibit Rental order form
- 3 Complete & send order form

Grey indicates standard header sign(s)



# standard exhibit rentals

**10' X 20'**  
EXHIBITS

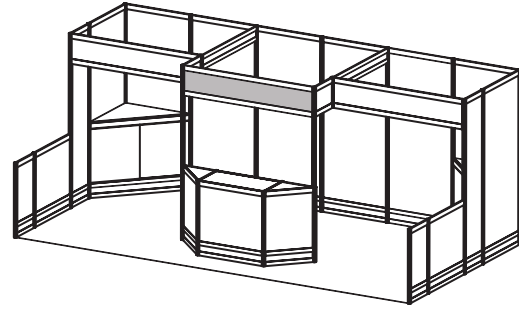

● GEM Model #6 - 10'x20'

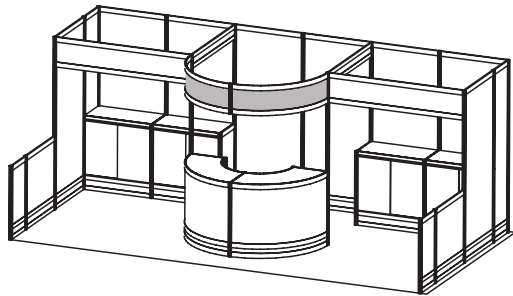

● GEM Model #7 - 10'x20'

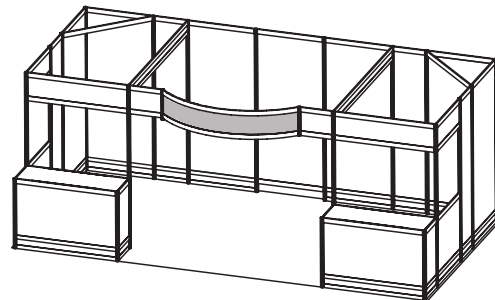

● GEM Model #8 - 10'x20'

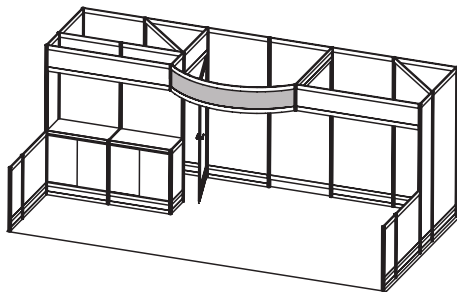

● GEM Model #9 - 10'x20'

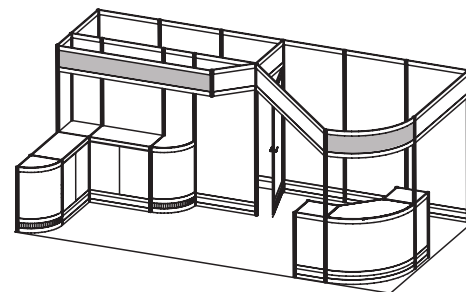

● GEM Model #10 - 10'x20' Corner

## 3 Easy Steps →

- 1 Select the model number that suits your needs
- 2 Choose carpet and panel colours on the GEM Exhibit Rental order form
- 3 Complete & send order form

Grey indicates standard header sign(s)





#25, 5805 - 76 Ave. SE Calgary, Alberta, T2C 5L8 Tel: (403) 243-2212 Fax: (403) 243-3868 Toll Free 1-800-636-8235 www.gesexpo.ca

SHOW: 2017 Calgary Boat & Sportsmen's Show

**DISCOUNT PRICE  
DEADLINE DATE:**

January 26, 2017

**EXHIBITOR INFORMATION**

BOOTH #: \_\_\_\_\_

COMPANY \_\_\_\_\_

STREET \_\_\_\_\_

CITY \_\_\_\_\_ PROV/STATE \_\_\_\_\_ CODE \_\_\_\_\_

E-MAIL \_\_\_\_\_

PHONE \_\_\_\_\_ FAX \_\_\_\_\_

CONTACT NAME \_\_\_\_\_

**CREDIT CARD AUTHORIZATION**

MASTERCARD  VISA  AMEX

--	--	--	--	--	--	--	--	--	--	--	--

EXPIRY DATE \_\_\_\_ / \_\_\_\_

CARDHOLDER NAME

CARDHOLDER SIGNATURE

CHEQUE ATTACHED (PAYABLE TO GES)

**ALL ORDERS MUST BE PREPAID IN FULL**

(ORDERS CAN NOT BE PROCESSED UNTIL PAYMENT IS RECEIVED) LIGHTS ARE INCLUDED IN SHOWCASES (ELECTRICAL SERVICES EXTRA)

QTY	#	DESCRIPTION	DISCOUNT PRICE	REGULAR PRICE	TOTAL
	1	Pedestal (White) 20"L x 20"W □ 28"H or □ 36"H	\$91.50	\$128.00	
	2	Pedestal White 40"L X 40"W (Tops are 20" X 20") (Unit Heights - 16"- 28" & 28"- 40")	\$458.50	\$642.00	
	3	Storage Counter (White) 80"L X 20"W X 40"H	\$272.50	\$381.50	
	4	Curved Counter (White) 60"L X 20"W X 40"H	\$187.00	\$262.00	
	5	99A Showcase (White/Glass) 40"L X 20"W X 40"H	\$187.00	\$262.00	
	6	99B Showcase (White/Glass) 40"L X 20"W X 40"H	\$190.50	\$266.50	
	7	99C Showcase (White/Glass) 26"L X 26"W X 96"H	\$276.00	\$386.00	
	8	99D Showcase (White/Glass) 40"L X 20"W X 96"H	\$390.00	\$546.00	

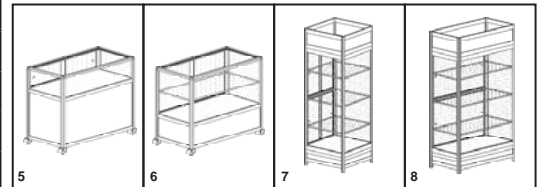
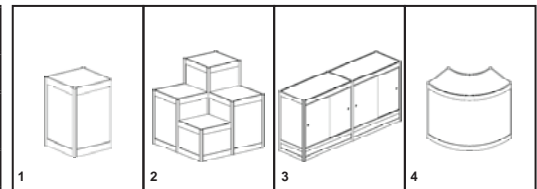

QTY	#	DESCRIPTION	DISCOUNT PRICE	REGULAR PRICE	TOTAL
	A	Waterfall With Eight Balls	\$18.50	\$25.50	
	C	Garmet Rail 39"W	\$47.50	\$66.50	
	D	Shelves □ Flat □ Angled 37"L X 12"W	\$40.00	\$56.00	
	E	Slatwall Panels - 37"W X 96"H Grey (Upgrade for standard panels)	\$110.50	\$154.50	

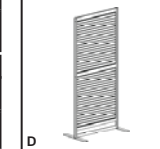
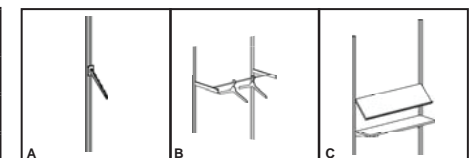

To Be Able To Rent These Accessories, You Must Order a GEM Hardwall Booth From GES

Please Attach Diagram Of Booth Indicating Locations For Grid Panels And/Or Slatwall. Grid Panels Cannot Be Installed In Corners.

**Terms & Conditions**

- All items subject to availability.
- No refunds/exchanges once show move-in begins.
- All claims or discrepancies must be settled prior to show closing.
- Exhibitor is responsible for all items for the duration of the show.
- Charges are for rental of equipment. All items remain the property of GES.
- All orders received after the Discount Price Date will be processed at the Regular Price.

SUBTOTAL	_____
5% GST	_____
TOTAL	_____
GST #R104060264	

I have read and understand the Terms & Conditions of my Agreement with GES.

\_\_\_\_\_  
Signature

\_\_\_\_\_  
Date

# SIGN ORDER FORM

#25, 5805 - 76 Ave. SE Calgary, Alberta, T2C 5L8 Tel: (403) 243-2212 Fax: (403) 243-3868 Toll Free 1-800-636-8235 www.gesexpo.ca

SHOW: 2017 Calgary Boat & Sportsmen's Show

**DISCOUNT PRICE DEADLINE DATE:** January 26, 2017

### EXHIBITOR INFORMATION

**BOOTH #:** \_\_\_\_\_

COMPANY \_\_\_\_\_

STREET \_\_\_\_\_

CITY \_\_\_\_\_ PROV/STATE \_\_\_\_\_ CODE \_\_\_\_\_

E-MAIL \_\_\_\_\_

PHONE \_\_\_\_\_ FAX \_\_\_\_\_

CONTACT NAME \_\_\_\_\_

### CREDIT CARD AUTHORIZATION

MASTERCARD     VISA     AMEX

--	--	--	--	--	--	--	--	--	--

EXPIRY DATE \_\_\_\_\_ / \_\_\_\_\_

CARDHOLDER NAME \_\_\_\_\_

CARDHOLDER SIGNATURE \_\_\_\_\_

CHEQUE ATTACHED (PAYABLE TO GES)

## ALL ORDERS MUST BE PREPAID IN FULL (ORDERS CAN NOT BE PROCESSED UNTIL PAYMENT IS RECEIVED)

### SIGN LAYOUT

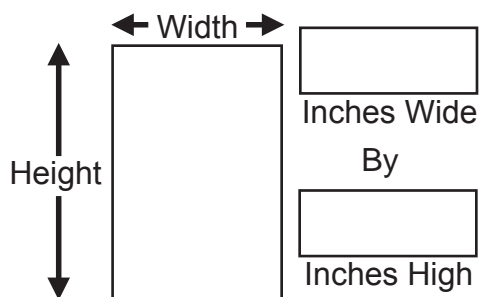

Sign Sizes	Discount Price	Regular Price
11" x 14"	\$ 45.50	\$ 63.50
14" x 22"	\$ 64.00	\$ 89.50
22" x 28"	\$ 99.50	\$139.50
7" x 44"	\$ 64.00	\$ 89.50
28" x 44"	\$170.50	\$238.50
40" x 60"	\$259.50	\$363.50

### LOGOS ARE NOT INCLUDED IN PRICING

### PLEASE PRINT OR TYPE WORDING REQUIRED:

## ALL SIGNS MUST BE PICKED UP FROM OUR ON-SITE SERVICE DESK.

**Terms & Conditions**

- All orders received after the Discount Price Date will be processed at the Regular Price.
- There are no refunds/exchanges on signs.
- All claims or discrepancies must be settled at the GES Service Centre prior to show closing.

<b>SUBTOTAL</b>	
<b>5% GST</b>	
<b>TOTAL</b>	
GST #R104060264	

**I have read and understand the Terms & Conditions of my Agreement with GES.**

\_\_\_\_\_  
**Signature**

\_\_\_\_\_  
**Date**

# LABOUR SERVICE ORDER FORM

#25, 5805 - 76 Ave. SE Calgary, Alberta, T2C 5L8 Tel: (403) 243-2212 Fax: (403) 243-3868 Toll Free 1-800-636-8235 www.gesexpo.ca

SHOW: 2017 Calgary Boat & Sportsmen's Show

**EXHIBITOR INFORMATION**

BOOTH #: \_\_\_\_\_

COMPANY \_\_\_\_\_

STREET \_\_\_\_\_

CITY \_\_\_\_\_ PROV/STATE \_\_\_\_\_ CODE \_\_\_\_\_

E-MAIL \_\_\_\_\_

PHONE \_\_\_\_\_ FAX \_\_\_\_\_

CONTACT NAME \_\_\_\_\_

**DISCOUNT PRICE DEADLINE DATE:** January 26, 2017

**CREDIT CARD AUTHORIZATION**

MASTERCARD   
  VISA   
  AMEX

--	--	--	--	--	--	--	--	--	--

EXPIRY DATE \_\_\_\_\_ / \_\_\_\_\_

CARDHOLDER NAME \_\_\_\_\_

CARDHOLDER SIGNATURE \_\_\_\_\_

CHEQUE ATTACHED (PAYABLE TO GES)

**CREDIT CARD AUTHORIZATION (ABOVE) MUST BE COMPLETED AS METHOD OF PAYMENT FOR THIS SERVICE**

LABOUR RATES ARE CHARGED PER PERSON AT **A MINIMUM CHARGE OF ONE HOUR**. LABOUR OVER ONE HOUR IS CHARGED IN 1/2 HOUR INCREMENTS. (A 30% SURCHARGE WILL BE APPLIED TO ON-SITE ORDERS)

<p><b>Straight Time</b> 8:00am - 4:00pm Monday - Friday</p> <p><b>\$ 72.50 PER HOUR</b></p>	<p><b>Overtime</b> After 4:00pm Weekdays &amp; All Day Sat, Sun and holidays</p> <p><b>\$108.50 PER HOUR</b></p>
---	--

**EXHIBITOR MUST REPORT TO GES SERVICE CENTRE TO RECEIVE THEIR LABOUR**

**INSTALLATION**      Set Up Drawings or Photos Attached:  yes  no

Carrier: \_\_\_\_\_ Delivery Date: \_\_\_\_\_ Delivery Time: \_\_\_\_\_  am  pm  
Day / Date/ Month / Year

**SUPERVISION**       By Exhibitor (Provide Name of Rep): \_\_\_\_\_  By GES 30% surcharge applies  
(Exhibitor MUST be Present to Supervise)      (Exhibitor does NOT have to be present)

DATE LABOUR REQUIRED: \_\_\_\_\_ START TIME REQUIRED: \_\_\_\_\_  am  pm  
Day / Date/ Month / Year

NUMBER OF PEOPLE REQUIRED  X HOURS PER PERSON  = TOTAL HOURS

**DISMANTLING**

Carrier: \_\_\_\_\_ Pick-up Date: \_\_\_\_\_ Pick-up Time: \_\_\_\_\_  am  pm  
Day / Date/ Month / Year

**SUPERVISION**       By Exhibitor (Provide Name of Rep): \_\_\_\_\_  By GES 30% surcharge applies  
(Exhibitor MUST be Present to Supervise)      (Exhibitor does NOT have to be present)

DATE LABOUR REQUIRED: \_\_\_\_\_ START TIME REQUIRED: \_\_\_\_\_  am  pm  
Day / Date/ Month / Year

NUMBER OF PEOPLE REQUIRED  X HOURS PER PERSON  = TOTAL HOURS

- Terms & Conditions**
- When Exhibitor is supervising labour the Exhibitor must check labour in and out at the GES Service Centre.
  - We reserve the right to change labourers and/or rates as shifts change.
  - All claims or discrepancies must be settled within one week of show closing.
  - Uncancelled labour will be charged a minimum fee of 1 hour per person.
  - GES Limits of Liability apply.

**I have read and understand the Terms & Conditions of my Agreement with GES.**

\_\_\_\_\_ \_\_\_\_\_ GST #R104060264  
**Signature** **Date**



**IN BOOTH FORKLIFT ORDER FORM**

#25, 5805 - 76 Ave. SE Calgary, Alberta, T2C 5L8 Tel: (403) 243-2212 Fax: (403) 243-3868 Toll Free 1-800-636-8235 www.gesexpo.ca

SHOW: 2017 Calgary Boat & Sportsmen's Show

**DISCOUNT PRICE DEADLINE DATE:** January 26, 2017

**EXHIBITOR INFORMATION**

BOOTH #: \_\_\_\_\_

COMPANY \_\_\_\_\_

STREET \_\_\_\_\_

CITY \_\_\_\_\_ PROV/STATE \_\_\_\_\_ CODE \_\_\_\_\_

E-MAIL \_\_\_\_\_

PHONE \_\_\_\_\_ FAX \_\_\_\_\_

CONTACT NAME \_\_\_\_\_

**CREDIT CARD AUTHORIZATION**

MASTERCARD  VISA  AMEX

\_\_\_\_\_|\_\_\_\_\_|\_\_\_\_\_|\_\_\_\_\_|\_\_\_\_\_|\_\_\_\_\_|\_\_\_\_\_|\_\_\_\_\_|\_\_\_\_\_|\_\_\_\_\_|

EXPIRY DATE \_\_\_\_/\_\_\_\_/\_\_\_\_

CARDHOLDER NAME \_\_\_\_\_

CARDHOLDER SIGNATURE \_\_\_\_\_

CHEQUE ATTACHED (PAYABLE TO GES)

**CREDIT CARD AUTHORIZATION (ABOVE) MUST BE COMPLETED AS METHOD OF PAYMENT FOR THIS SERVICE**

IN-BOOTH FORKLIFT SERVICE IS AVAILABLE TO EXHIBITORS REQUIRING ASSISTANCE WITH POSITIONING OF EXHIBITOR MATERIALS WITHIN YOUR BOOTH SPACE. (MINIMUM CHARGE OF 1 HOUR.)

**THIS SERVICE IS NOT PAID FOR BY SHOW MANAGEMENT**

**Straight Time**  
**8:00am - 4:00pm**  
**Monday - Friday**  
**\$110.50 PER HOUR**

**Overtime**  
**4:00pm - 6:00pm**  
**Monday - Friday**  
**8:00am - 4:00pm Sat & Sun**  
**\$165.50 PER HOUR**

A 30% SURCHARGE WILL BE APPLIED TO ON-SITE ORDERS.  
 ALL RATES INCLUDE FORKLIFT AND DRIVER (5% GST IS APPLICABLE)

**PLEASE COMPLETE THE FOLLOWING:**

SUPERVISOR NAME: \_\_\_\_\_ (EXHIBITOR MUST BE PRESENT TO SUPERVISE)

INSTALLATION TIME REQUIRED: \_\_\_\_\_ Day \_\_\_\_\_ Date \_\_\_\_\_ Month \_\_\_\_\_ # of Hours \_\_\_\_\_ # of Forklifts

DISMANTLING TIME REQUIRED: \_\_\_\_\_ Day \_\_\_\_\_ Date \_\_\_\_\_ Month \_\_\_\_\_ # of Hours \_\_\_\_\_ # of Forklifts

**APPROXIMATE TIMES:**

**MOVE-IN** Start: \_\_\_\_\_ am pm Finish: \_\_\_\_\_ am pm Total Hours: \_\_\_\_\_

**MOVE-OUT** Start: \_\_\_\_\_ am pm Finish: \_\_\_\_\_ am pm Total Hours: \_\_\_\_\_

**SERVICES OVER 1 HOUR MINIMUM WILL BE CHARGED IN 1/2 HOUR INCREMENTS PER FORKLIFT.**

**Terms & Conditions**

- Exhibitor must check forklift/driver in and out at the GES Service Centre.
- We reserve the right to change labourers and/or rates as shifts change.
- All claims or discrepancies must be settled within one week of show closing.
- GES Limits of Liability apply.

**I have read and understand the Terms & Conditions of my Agreement with GES.**

\_\_\_\_\_  
 Signature Date

GST #R104060264

1. GES CANADA Exposition Services herein known as GES and its subcontractors shall not be responsible for damage to uncrated materials; materials improperly packed, glass breakage or concealed damage.

2. Relative to inbound shipments, there may be a lapse of time between the delivery of shipment(s) to the booth by GES or its subcontractors and the arrival of the Exhibitor's representative at the booth. Similarly, relative to outgoing shipment(s), it is possible that there will be a lapse of time between the completion of packing and the actual pick-up of materials from the booth for loading onto a carrier. It is understood that during such times the shipment(s) will be left in the booth unattended.

Therefore, it is agreed that GES and its subcontractors are not responsible for the loss or disappearance of Exhibitor's materials after the same have been delivered to Exhibitor's booth, nor are GES and its subcontractors responsible for Exhibitor's materials before they are picked up from the Exhibitor's booth for loading after the show. Consequently, all bills of lading covering outgoing shipment(s) submitted to GES or its subcontractors by Exhibitor will be checked at the time of pick-up from the booth and corrected where discrepancies exist.

3. GES and its subcontractors shall not be held liable for any damage incurred during the handling of equipment requiring special devices to properly load, place or reload unless advance notice has been given to GES in time to obtain the proper equipment.

4. GES and its subcontractors shall not be responsible for loss, delay or damage due to strikes, lockouts or work stoppages of any kind.

5. GES and its subcontractors shall not be responsible for ordinary wear and tear in handling of equipment, nor for loss or damage due to fire, theft, windstorm, water, vandalism, acts of God, mysterious disappearance or other causes beyond their control.

6. It is understood that GES and its subcontractors are not insurers. Insurance, if any, shall be obtained by the Exhibitor. Amounts payable to GES hereunder are based on the scope of the liability as herein set forth and are unrelated to the value of the Exhibitor's property. It is further understood and agreed that GES and its subcontractors do not provide for full liability should loss or damage occur. It is agreed that if GES or its subcontractors should be found liable for loss or damage to Exhibitor's equipment, the liability shall be limited to the specific article that was physically lost or damaged. Such liability shall be limited to a sum equal to \$0.30 per pound per article, with a maximum liability of \$50.00 per item or \$1,000.00 per shipment, whichever is less, as agreed upon damages and exclusive remedy. Provisions of this paragraph shall apply if loss or damage, regardless of cause or origin, results directly or indirectly to property through performance services to

Exhibitor's or from negligence, active or otherwise, by GES, its subcontractors or their employees.

7. GES and its subcontractors shall not be liable to any extent whatsoever for any actual, potential or assumed loss of profits or revenues or for any collateral costs that may result from any loss or damage to Exhibitor's materials which may make it impossible or impracticable to exhibit same.

8. Claims for loss or damage must be submitted to GES by the close of the show. No suit or action shall be brought against GES or its subcontractors more than one year after the cause of action.

9. The Exhibitor agrees, in connection with the receipt, handling, temporary storage and reloading of its materials, that GES and its subcontractors will provide these services as Exhibitor's agent and not as bailee or shipper. If any employee of GES or its subcontractors shall sign a delivery receipt, bill of lading or other document, we agree that GES or its subcontractor will do so as the Exhibitor's agent, and the Exhibitor accepts the responsibility thereof.

10. GES and its subcontractors shall not be liable for shipments received without receipts, freight bills or specified unit counts on receipts or freight bills, such as a courier or van lines. Such shipments will be delivered to booth without guarantee of piece count or condition.

11. Empty container labels will be available at the GES Service Centre. Affixing the labels is the sole responsibility of the Exhibitor or its representative. It is understood that these labels are used for EMPTY STORAGE ONLY, and GES and its subcontractors assume no responsibility for loss or damage to contents while containers are in storage or for mislabelled containers.

12. In order to expedite removal of materials from the show site, GES shall have the authority to change designated carriers, if such carriers do not pick up on time. Where no disposition is made by the Exhibitor, materials will be taken to a warehouse to await Exhibitor's shipping instructions, and the Exhibitor agrees to be responsible for payment of charges relating to such handling at the warehouse. GES assumes no liability as a result of such re-routing or handling.

13. The Exhibitor agrees, in the event of a dispute with GES or its subcontractors relative to any loss or damage to any of your materials or equipment, that the Exhibitor will not withhold payment in any amount due to GES for material handling services or any other services provided by GES or its subcontractors as an offset against the amount of the alleged loss or damage. Instead, the Exhibitor agrees to pay GES prior to the close of the show for all such charges and further agrees that any claim the Exhibitor may have against GES or its subcontractors shall be pursued independently by the Exhibitor as a completely separate transaction to be resolved on its own merits.

The consignment or delivery of a shipment to GES or its subcontractors by an Exhibitor or by any shipper on behalf of the Exhibitor shall be construed as an acceptance by such Exhibitor (and/or other shipper) of the terms and conditions set forth in Sections 1 through 13 above.

**Be sure your materials are insured** from the time they leave your firm until they are returned after the show. It is suggested that Exhibitors arrange all risk coverage. This can usually be done by riders to existing policies. Contact your insurance representative. Be sure your liability insurance is in effect during transit and return of your materials, during storage and at show site.