



**The Edmonton Boat & Sportsmen's Show**  
**March 16 - 19, 2017**  
**Edmonton EXPO Centre**

**GES** is pleased to have been selected as the official service contractor by the show Organizer to design and produce your show. Our goal is to ensure your show participation is a success.

**GES** is involved in many areas relative to the show and if at any time during the planning process you are unsure where to turn, just ask us, we are at your service.

Please ensure that you review this section carefully as it contains information, **DISCOUNT PRICES** and order forms for each of the many services being provided by **GES**.

For your convenience, we will be offering the following services:

**Expresso Online Ordering**  
**Furnishings**  
**Specialty Furnishings**  
**Carpet & Underpadding**  
**Booth Cleaning**  
**Modular Exhibit Systems & Accessories**  
**Graphics**  
**Installation & Dismantling Labour**  
**In-Booth Forklifting**  
**Material Handling**  
**GES Logistics / Shipping**

To take advantage of our **DISCOUNT PRICING**, all order forms and full payment must be received on or before the Discount Date of **February 27, 2017** as indicated on each form. **GES** accepts Visa, Mastercard, American Express, Cheques and Cash as methods of payment for our services. All exhibitors are responsible for payment of GST when exhibiting in Alberta.

If you need assistance or additional information, please contact our **Exhibitor Services Department at (780) 469-7767**.



## Accelerate your experience with Expresso exhibit planning, ordering and management.

Exhibitors can order everything they need for their tradeshow exhibit through Expresso, our simple to navigate, picture-driven system that satisfies your need for speed. With just a few clicks exhibitors can order GES products and services including:

- Booth furniture.
- Carpet and flooring.
- Material handling.
- Booth labour.
- And much more.



## Expresso is more than just an online exhibitor manual. Exhibitors can:

- Order exhibit products and services.
- Print shipping labels.
- View important show and event information.
- Download the show schedule into Outlook or iCalendar.
- View account order status and history.

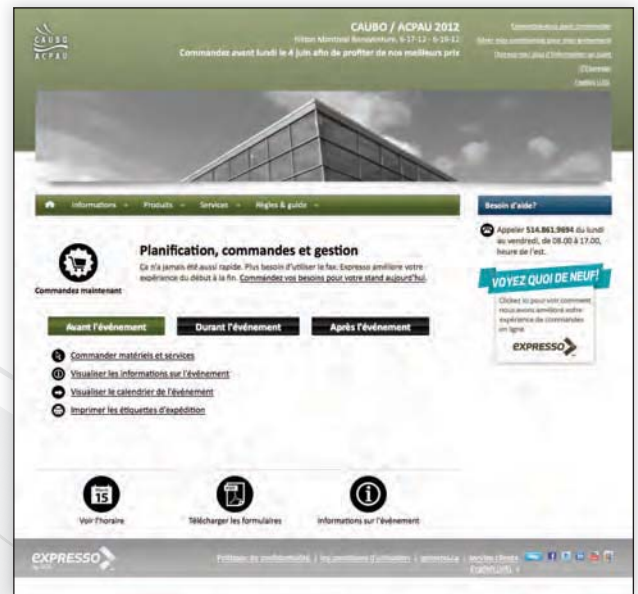

## Experience a difference with Expresso.

- Each show has their own custom website.
- Runs on all browsers for PCs, Macs and tablets.
- Everything in one place; all organizer and show information, ordering and even third party forms.
- Keeps you on-time and on-budget.



**ORDER FORM RECAP**

<b>SHOW NAME:</b>	<b>The Edmonton Boat &amp; Sportsmen's Show</b>	<b>DISCOUNT PRICE DEADLINE DATE:</b>	February 27, 2017
<b>SHOW DATE:</b>	<b>March 16 - 19, 2017</b>		

**TO:** **GES Edmonton**  
**FAX:** **780-469-1619**  
**EMAIL:** **edmonton@ges.com**  
**DATE:** \_\_\_\_\_  
**FROM:** \_\_\_\_\_  
**COMPANY:** \_\_\_\_\_  
**PHONE:** \_\_\_\_\_  
**EMAIL:** \_\_\_\_\_  
**SHOW NAME:** \_\_\_\_\_  
**BOOTH #:** \_\_\_\_\_



To help us ensure we have received your entire order and we have the correct totals, check off those forms you are sending us and complete value section for each form

	GES ORDER FORM (s)	Pg. Total
<input type="checkbox"/>	Credit Card Authorization	\$
<input type="checkbox"/>	Third Party Billing	\$
<input type="checkbox"/>	Furnishings	\$
<input type="checkbox"/>	Speciality Furnishings	\$
<input type="checkbox"/>	Carpet & Underpadding	\$
<input type="checkbox"/>	Booth Cleaning	\$
<input type="checkbox"/>	Modular Exhibit System Rentals	\$
<input type="checkbox"/>	Modular Exhibit System Accessories	\$
<input type="checkbox"/>	Graphics	\$
<input type="checkbox"/>	Installation & Dismantle Services	\$
<input type="checkbox"/>	In-Booth Forklifting	\$
<input type="checkbox"/>	Material Handling	\$
<input type="checkbox"/>	Logistics	\$

*Please call to confirm receipt of your order.*

To receive Discount Pricing send your order in by the Discount Price Deadline Date noted above.

**THANK YOU FROM GES**

<b>SHOW NAME:</b>	<b>The Edmonton Boat &amp; Sportsmen's Show</b>
<b>SHOW DATE:</b>	<b>March 16 - 19, 2017</b>

<b>DISCOUNT PRICE DEADLINE DATE:</b>	February 27, 2017
--	-------------------

**Discount Pricing:**

To qualify for **Discount Pricing**, orders must be received **with payment in full on or before the deadline date**. Late orders will be charged the **Regular Price**. Orders without payment cannot be processed until payment is received and may be charged the **Regular Price**.

**Method of Payment:**

GES accepts American Express, MasterCard, Visa, Cheque and Bank Wire Transfers. Purchase Orders are not considered payment. **Exhibitors will be charged a \$25.00 fee for returned NSF cheques.**

**Bank Wire Transfer Information:**

To properly credit your account, please complete the **BANK WIRE TRANSFER FORM**, available upon request, and send the following information to the GES Exposition Services (Canada) Limited address listed on the Bank Wire Transfer Form.

**NOTE:** There is a minimum \$20.00 Service Charge (North America) & \$40.00 (International) applicable on all wire transfers. Fees vary depending on banks processing wire transfers. Also, wire transfers can take 3 to 10 business days to be cleared. Ensure you leave enough time to receive the benefit of the discount. Orders are not processed until payment is received, this includes wire transfers.

**PAYMENT SCHEDULE:**

Payment for all services must be pre-paid in full. GES will not provide Material Handling, In-Booth Forklifts, or Installation and Dismantle Labour Services without a company's **CREDIT CARD AUTHORIZATION FORM** on file.

**THIRD PARTY BILLING:**

Arrangements can be made for an exhibit house or other agent to manage exhibit & order services. GES will agree to this arrangement if the exhibit house or agent makes satisfactory payment arrangements prior to start of move-in. In the event the authorized Third Party does not pay, the exhibiting company is ultimately responsible for all charges incurred on its behalf. See **THIRD PARTY BILLING REQUEST FORM**.

**ADJUSTMENTS AND CANCELLATIONS:**

Adjustments to invoice(s) **will not be made after the close of the show**. Some items, services and labour are subject to cancellation fees. Refer to each order form for details.

**EXHIBITORS MUST PAY APPLICABLE TAXES ON ALL ORDERS.**

**EXHIBITORS ARE RESPONSIBLE FOR ANY UNPAID ORDERS. ALL ORDERS MUST BE PAID IN FULL PRIOR TO RELEASE OF GOODS FROM THE SHOW FLOOR**





7730 - 34 Street NW, Edmonton, AB T6B 3J6 Phone: 780.469.7767 Fax: 780.469.1619 Toll Free: 877.505.7767 edmonton@ges.com

# THIRD PARTY BILLING AUTHORIZATION FORM

SHOW NAME: **The Edmonton Boat & Sportsmen's Show**  
SHOW DATE: **March 16 - 19, 2017**

DISCOUNT PRICE  
DEADLINE DATE: **Monday, February 27, 2017**

### EXHIBITOR INFORMATION

### IMPORTANT - READ CAREFULLY

BOOTH #: \_\_\_\_\_  
COMPANY: \_\_\_\_\_  
STREET: \_\_\_\_\_  
CITY: \_\_\_\_\_ PROV/STATE: \_\_\_\_\_ CODE: \_\_\_\_\_  
EMAIL: \_\_\_\_\_  
PHONE: \_\_\_\_\_ FAX: \_\_\_\_\_  
CONTACT NAME: \_\_\_\_\_

An exhibit house or other third party agent may handle display and booth arrangements and be charged for services. GES will agree to this arrangement if the exhibit house or agent makes satisfactory arrangements.  
Both firms must complete this form and return to GES by the Discount Price Deadline Date. It is understood and agreed that the exhibitor (exhibiting company) is ultimately responsible for payment of charges. If the named third party has NOT paid any outstanding invoices before the last day of the show, any and all outstanding balances will be charged to the exhibiting company's credit card.

## Exhibiting Company

Name of Exhibiting Company \_\_\_\_\_ Phone# \_\_\_\_\_ Fax # \_\_\_\_\_  
Address \_\_\_\_\_ City \_\_\_\_\_ Prov / State \_\_\_\_\_ Code / Zip \_\_\_\_\_  
Authorized Name (Print) \_\_\_\_\_ Authorized Signature \_\_\_\_\_

### CREDIT CARD AUTHORIZATION

VISA  AMERICAN EXPRESS  MASTERCARD EXPIRY DATE: \_\_\_\_\_  
TYPE OF CARD  PERSONAL  CORPORATE  
CARD #

CARDHOLDER'S NAME (PRINT): \_\_\_\_\_

CARDHOLDER'S SIGNATURE: \_\_\_\_\_

## Third Party / Exhibit House

Name of Third Party / Exhibit House \_\_\_\_\_ Phone# \_\_\_\_\_ Fax # \_\_\_\_\_  
Address \_\_\_\_\_ City \_\_\_\_\_ Prov / State \_\_\_\_\_ Code / Zip \_\_\_\_\_  
Authorized Name (Print) \_\_\_\_\_ Authorized Signature \_\_\_\_\_

### CREDIT CARD AUTHORIZATION

VISA  AMERICAN EXPRESS  MASTERCARD EXPIRY DATE: \_\_\_\_\_  
TYPE OF CARD  PERSONAL  CORPORATE  
CARD #

CARDHOLDER'S NAME (PRINT): \_\_\_\_\_

CARDHOLDER'S SIGNATURE: \_\_\_\_\_

ALL GES SERVICES ARE TO BE CHARGED TO THE THIRD PARTY / EXHIBIT HOUSE EXCEPT FOR THE FOLLOWING:

### PLEASE SEE NOTE REGARDING GES TERMS AND CONDITIONS BELOW

All equipment rental orders placed with GES are bound by the terms and conditions specific to each rental order form, material handling terms and conditions and GES standard terms and conditions located at the back of this kit. By signing below, you agree to all these terms and conditions. Without an authorized signature and date below, your order will not be processed.

I HAVE READ AND UNDERSTAND THE TERMS & CONDITIONS OF MY AGREEMENT WITH GES.

Signature \_\_\_\_\_ Print Name & Title \_\_\_\_\_ Date \_\_\_\_\_



5675 McLaughlin Road, Mississauga, Ontario, L5R 3K5 Phone: 905-283-0500 Fax: 905-283-0501

**Please complete and return this form to : Jolanta Baloniak, Accounts Receivable  
GES Exposition Services (Canada) Limited  
Email: ar@ges.com Fax: 905-283-0501**

**Your Company Name:** \_\_\_\_\_

**Contact Name:** \_\_\_\_\_

**Contact Number:** \_\_\_\_\_

**Booth Number:** \_\_\_\_\_ **Event Name:** \_\_\_\_\_

**GES BANK INFORMATION**

PLEASE INCLUDE ALL OF THE FOLLOWING INFORMATION TO ENSURE YOUR FUNDS REACH OUR BANK

**Beneficiary's Name:** **GES Exposition Services (Canada) Limited**  
**Bank Name:** Bank of Montreal  
**Address:** 350 - 7th Avenue SW  
 Calgary, AB  
 T2P 3N9

IF YOU ARE SENDING  
CANADIAN DOLLARS (\$CDN)



**EFT/Direct Deposit**

Institution code #: 001  
 Transit #: 00109  
 Account #: 1967-990

IF YOU ARE SENDING  
AMERICAN DOLLARS (\$US)



Institution code #: 001  
 Transit #: 00109  
 Account #: 4773-410

**Wire Transfers**

Account #: 1967-990  
 Beneficiary's Bank: //CC000100109  
 Swift Code: BOFMCAM2

Account #: 4773-410  
 Beneficiary's Bank: //CC000100109  
 Intermediary bank: Wells Fargo Bank (FKA Wachovia)  
 Swift Code: PNBUS3NNYC

Routing / BIC / NCC / BSC or ABA Number: 026005092

**Invoice Amount:** \_\_\_\_\_

**Date of Transfer:** \_\_\_\_\_

**\*Minimum Bank Charge:** \$20.00 (North American) \$40.00 (International) \_\_\_\_\_

**Total:** \_\_\_\_\_

**Please Note:** Please ensure transfer is made by the deadline date on your Order Form or Quotation. Additional charges will be incurred for late payments, and services may be delayed.  
 \*Minimum Bank Charges as shown above, reflect GES's bank charges only.  
 Any additional wire transfer and EFT fees are the exhibitor's responsibility.





7730 - 34 Street NW, Edmonton, AB T6B 3J6 Phone: 780.469.7767 Fax: 780.469.1619 Toll Free: 877.505.7767 edmonton@ges.com

# FURNISHINGS ORDER FORM

SHOW NAME: **The Edmonton Boat & Sportsmen's Show**  
 SHOW DATE: **March 16 - 19, 2017**

DISCOUNT PRICE DEADLINE DATE: **Monday, February 27, 2017**

**EXHIBITOR INFORMATION**

**CREDIT CARD AUTHORIZATION**

BOOTH #: \_\_\_\_\_  
 COMPANY: \_\_\_\_\_  
 STREET: \_\_\_\_\_  
 CITY: \_\_\_\_\_ PROV/STATE: \_\_\_\_\_ CODE: \_\_\_\_\_  
 EMAIL: \_\_\_\_\_  
 PHONE: \_\_\_\_\_ FAX: \_\_\_\_\_  
 CONTACT NAME: \_\_\_\_\_

**NO ORDER WILL BE CONSIDERED FINAL UNTIL CREDIT CARD AUTHORIZATION FORM IS COMPLETED AND SUBMITTED WITH THIS FORM.**

**ALL ORDERS MUST BE PREPAID IN FULL (ORDERS CANNOT BE PROCESSED UNTIL PAYMENT IS RECEIVED)**

**FURNISHINGS**

**SKIRTED TABLES 30" HIGH**

QTY	DESCRIPTION	DISCOUNT PRICE	REGULAR PRICE	TOTAL	<input type="checkbox"/> BLACK <input type="checkbox"/> BLUE <input type="checkbox"/> SILVER <input type="checkbox"/> WHITE <input type="checkbox"/> RED <input type="checkbox"/> GREEN <input type="checkbox"/> BURGUNDY				
					QTY	DESCRIPTION	DISCOUNT PRICE	REGULAR PRICE	TOTAL
	GREY FABRIC SIDE CHAIR	\$41.00	\$57.00						
	GREY FABRIC COUNTER STOOL	\$89.50	\$125.50			4 FT LONG X 2 FT WIDE	\$85.50	\$119.50	
	GREY FABRIC ARM CHAIR	\$42.00	\$74.50			6 FT LONG X 2 FT WIDE	\$94.00	\$131.50	
	PLASTIC FOLDING CHAIR	\$26.00	\$48.50			8 FT LONG X 2 FT WIDE	\$101.50	\$142.50	
	COFFEE TABLE 18" HIGH ROUND	\$57.00	\$79.50			SKIRTED FOURTH SIDE	\$37.00	\$51.50	
	STARBASE TABLE 30" ROUND 30" HIGH	\$74.50	\$104.50		<b>SKIRTED COUNTER 42" HIGH</b>				
					<input type="checkbox"/> BLACK <input type="checkbox"/> BLUE <input type="checkbox"/> SILVER <input type="checkbox"/> WHITE				
	COCKTAIL TABLE 30" ROUND 40" HIGH	\$90.00	\$125.50		QTY	DESCRIPTION	DISCOUNT PRICE	REGULAR PRICE	TOTAL
	22" X 28" CHROME SIGN HOLDER	\$48.50	\$68.00			4 FT LONG X 2 FT WIDE	\$97.50	\$136.50	
	EASEL	\$41.00	\$57.50			6 FT LONG X 2 FT WIDE	\$120.00	\$168.00	
	SMALL GOLD BALLOT DRUM	\$74.50	\$104.50			8 FT LONG X 2 FT WIDE	\$147.00	\$206.00	
	BAG HOLDER 40" HIGH	\$68.00	\$95.50			SKIRTED FOURTH SIDE	\$37.00	\$51.50	
	TAPE STANCHION (7')	\$43.50	\$60.50		<b>NON SKIRTED 30" HIGH TABLES (VINYL ONLY)</b>				
	GARMENT RACK ON WHEELS	\$46.50	\$65.00			<input type="checkbox"/> 4FT <input type="checkbox"/> 6FT <input type="checkbox"/> 8FT	\$68.00	\$95.50	
	WASTEBASKET	\$22.50	\$32.00		<b>NON SKIRTED 42" HIGH TABLES (VINYL ONLY)</b>				
	BASEPLATE & 8 FT H POLE	\$20.50	\$29.00			<input type="checkbox"/> 4FT <input type="checkbox"/> 6FT <input type="checkbox"/> 8FT	\$109.00	\$153.00	
	6FT - 10 FT CROSSBAR	\$15.50	\$22.00		<b>CUSTOM BOOTH DRAPING</b>				
	BAR FRIDGE	\$212.00	\$297.00		<input type="checkbox"/> BLACK <input type="checkbox"/> BLUE <input type="checkbox"/> SILVER <input type="checkbox"/> WHITE <input type="checkbox"/> RED <input type="checkbox"/> GREEN <input type="checkbox"/> BURGUNDY				
					QTY	DESCRIPTION	DISCOUNT PRICE	REGULAR PRICE	TOTAL
						3' HIGH (PER LINEAR FOOT)	\$7.00	\$10.00	
						8' HIGH (PER LINEAR FOOT)	\$8.00	\$11.00	

**TERMS AND CONDITIONS**

- ALL ORDERS RECEIVED AFTER DISCOUNT PRICE DATE WILL BE PROCESSED AT THE REGULAR PRICE.
- EXHIBITOR IS RESPONSIBLE FOR ALL ITEMS FOR THE DURATION OF THE SHOW.
- IF A COLOUR IS NOT CHOSEN, GES WILL CHOOSE A COLOUR FOR YOU.
- CHARGES ARE FOR RENTAL OF EQUIPMENT ONLY. ALL ITEMS REMAIN THE PROPERTY OF GES.
- GES IS NOT RESPONSIBLE FOR EXHIBIT MATERIALS LEFT IN MODULAR EXHIBIT SYSTEM OR COUNTER STORAGE UNITS.
- ALL CLAIMS OR DISCREPANCIES MUST BE SETTLED AT THE GES SERVICE CENTRE PRIOR TO SHOW CLOSING.
- NO REFUNDS/EXCHANGES ON CANCELLED SKIRTED TABLES OR CUSTOM BOOTH DRAPING ONCE DELIVERED.
- 50% REFUND ON FURNISHINGS CANCELLED PRIOR TO SHOW OPENING EXCEPT AS NOTED ABOVE.

**I HAVE READ AND UNDERSTAND THE TERMS & CONDITIONS OF MY AGREEMENT WITH GES.**

<b>SUBTOTAL</b>	
<b>GST 5%</b>	
<b>TOTAL</b>	
<b>INCLUDE TOTAL FROM THIS PAGE ON ORDER CHECKLIST SHEET</b>	

SIGNATURE \_\_\_\_\_

DATE \_\_\_\_\_



**GES** *Global Experience Specialists*

# furnishings



Grey Fabric Side Chair



Grey Fabric Counter Stool



Grey Fabric Arm Chair



Steno Chair



30" Round / 30" High Starbase Table



30" Round / 18" High Coffee Table



4' and 6' Long Skirted Counter with White Vinyl Top



4', 6', or 8' Long Skirted Table with White Vinyl Top





**GES** *Global Experience Specialists*

# furnishings



22" W X 28" H  
Chrome Sign Holder  
(sign extra)



Easel

Gold Ballot Drum



Plexi Pocket  
(Wall Mountable only,  
not self-standing)



40" W x 20" D x 41" H  
White Counter Storage Unit



Bag Holder 41" H



Stanchions  
6' Belt



Plastic  
Wastebasket



7730 - 34 Street NW, Edmonton, AB T6B 3J6 Phone: 780.469.7767 Fax: 780.469.1619 Toll Free: 877.505.7767 edmonton@ges.com

**SHOW NAME:** The Edmonton Boat & Sportsmen's Show  
**SHOW DATE:** March 16 - 19, 2017

**DISCOUNT PRICE DEADLINE DATE:** Monday, February 27, 2017

**EXHIBITOR INFORMATION**

**CREDIT CARD AUTHORIZATION**

**BOOTH #:** \_\_\_\_\_

**COMPANY:** \_\_\_\_\_

**STREET:** \_\_\_\_\_

**CITY:** \_\_\_\_\_ **PROV/STATE:** \_\_\_\_\_ **CODE:** \_\_\_\_\_

**EMAIL:** \_\_\_\_\_

**PHONE:** \_\_\_\_\_ **FAX:** \_\_\_\_\_

**CONTACT NAME:** \_\_\_\_\_

**NO ORDER WILL BE CONSIDERED  
FINAL UNTIL CREDIT CARD  
AUTHORIZATION FORM IS COMPLETED  
AND SUBMITTED WITH THIS FORM**

**ALL ORDERS MUST BE PREPAID IN FULL  
(ORDERS CANNOT BE PROCESSED UNTIL PAYMENT IS RECEIVED)**

QTY	ITEM #	DESCRIPTION	DISCOUNT PRICE	REGULAR PRICE	Total
	41A (EFBS)	FANBACK STOOL	\$128.00	\$179.50	
	41B (FPEDT)	COCKTAIL TABLE 30" ROUND 40" HIGH	\$90.00	\$125.50	
	42A (EBLBS)	LEATHER BISTRO STOOL	\$150.50	\$210.50	
	43A (EGFBS)	FABRIC BISTRO STOOL	\$164.50	\$230.00	
	44B (EBMT)	42" MEETING TABLE	\$150.50	\$210.50	
	45A (EGFC)	LEATHER MEETING CHAIR	\$110.50	\$154.50	
	(EBLHC)	EXECUTIVE LEATHER HIGH BACK ROLLING CHAIR	\$146.00	\$204.50	
	(EBLS3)	LEATHER SOFA - 3 SEATER	\$251.00	\$351.50	
	(EBLS2)	LEATHER SOFA - 2 SEATER	\$208.50	\$292.00	
	(EBLS1)	LEATHER SOFA CHAIR - 1 SEAT	\$163.50	\$228.50	
	(ECTC3)	COFFEE TABLE	\$72.50	\$101.50	
	(EETC3)	END TABLES	\$50.50	\$70.50	
	(FLR)	LITERATURE RACK	\$99.50	\$139.50	
	(GGP)	24" X 72" GRID PANEL	\$34.50	\$48.50	

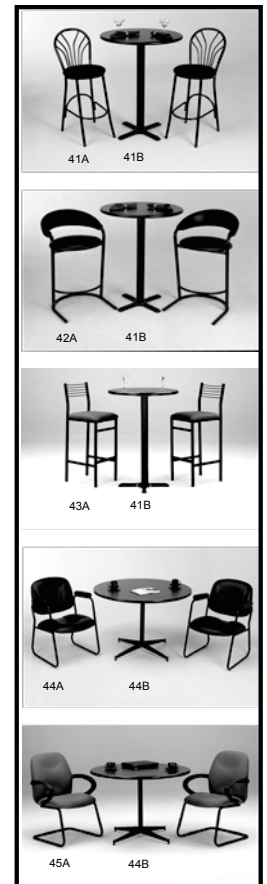

**TERMS AND CONDITIONS**

- ALL ORDERS RECEIVED AFTER DISCOUNT PRICE DATE WILL BE PROCESSED AT THE REGULAR PRICE.
- EXHIBITOR IS RESPONSIBLE FOR ALL ITEMS FOR THE DURATION OF THE SHOW.
- IF A COLOUR IS NOT CHOSEN, GES WILL CHOOSE A COLOUR FOR YOU.
- CHARGES ARE FOR RENTAL OF EQUIPMENT ONLY. ALL ITEMS REMAIN THE PROPERTY OF GES.
- GES IS NOT RESPONSIBLE FOR EXHIBIT MATERIALS LEFT IN MODULAR EXHIBIT SYSTEM OR COUNTER STORAGE UNITS.
- ALL CLAIMS OR DISCREPANCIES MUST BE SETTLED AT THE GES SERVICE CENTRE PRIOR TO SHOW CLOSING.
- NO REFUNDS/EXCHANGES ON CANCELLED SKIRTED TABLES OR CUSOM BOOTH DRAPING ONCE DELIVERED.
- 50% REFUND ON FURNISHINGS CANCELLED PRIOR TO SHOW OPENING EXCEPT AS NOTED ABOVE.

**I HAVE READ AND UNDERSTAND THE TERMS & CONDITIONS OF MY AGREEMENT WITH GES.**

<b>SUBTOTAL</b>	
<b>GST 5%</b>	
<b>TOTAL</b>	
<b>INCLUDE TOTAL FROM THIS PAGE ON ORDER CHECKLIST SHEET</b>	

\_\_\_\_\_  
SIGNATURE

\_\_\_\_\_  
DATE



7730 - 34 Street NW, Edmonton, AB T6B 3J6 Phone: 780.469.7767 Fax: 780.469.1619 Toll Free: 877.505.7767 edmonton@ges.com

# CARPET ORDER FORM

<b>SHOW NAME:</b>	<b>The Edmonton Boat &amp; Sportsmen's Show</b>	<b>DISCOUNT PRICE DEADLINE DATE:</b>	<b>Monday, February 27, 2017</b>
<b>SHOW DATE:</b>	<b>March 16 - 19, 2017</b>		

EXHIBITOR INFORMATION	CREDIT CARD AUTHORIZATION
<b>BOOTH #:</b> _____  <b>COMPANY:</b> _____  <b>STREET:</b> _____  <b>CITY:</b> _____ <b>PROV/STATE:</b> _____ <b>CODE:</b> _____  <b>EMAIL:</b> _____  <b>PHONE:</b> _____ <b>FAX:</b> _____  <b>CONTACT NAME:</b> _____	<p><b>NO ORDER WILL BE CONSIDERED FINAL UNTIL CREDIT CARD AUTHORIZATION FORM IS COMPLETED AND SUBMITTED WITH THIS FORM.</b></p>

**ALL ORDERS MUST BE PREPAID IN FULL  
(ORDERS CANNOT BE PROCESSED UNTIL PAYMENT IS RECEIVED)**

### BOOTH CARPET - STANDARD SIZE

PLEASE NOTE: CARPET WILL BE INSTALLED CLEAN, SHOULD EXHIBITOR REQUIRE ADDITIONAL CLEANING AFTER SETUP, AN INITIAL CLEANING FEE WILL APPLY. EXHIBITORS ORDERING MULTIPLE PIECES OF CARPET IN THIS SECTION MAY NOT RECEIVE THE SAME DYELOT.

QTY.	DESCRIPTION	DISCOUNT PRICE	REGULAR PRICE	TOTAL
	10 X 10 INLINE	\$161.00	\$225.50	
	10 X 20 INLINE	\$322.50	\$451.00	
	10 X 30 INLINE (STRAIGHT LINE)	\$483.50	\$677.00	

**COLOUR SELECTION:**       BLACK       BLUE       GREY       RED       GREEN

### BOOTH CARPET - CUSTOM SIZE

IF YOUR BOOTH REQUIRES A SIZE NOT LISTED ABOVE, PLEASE COMPLETE THIS SECTION. PLEASE NOTE: CARPET WILL BE INSTALLED CLEAN, SHOULD EXHIBITOR REQUIRE ADDITIONAL CLEANING AFTER SETUP, AN INITIAL CLEANING FEE WILL APPLY.

<b>BOOTH SIZE:</b> _____ FT. X _____ FT. = _____ SQ. FT.	\$1.61	\$2.26	
--	--------	--------	--

**COLOUR SELECTION:**       BLACK       BLUE       GREY       RED       GREEN

### UNDERPADDING - PRICE PER SQUARE FOOT INSTALLED (100 SQ. FT. MIN.)

<b>BOOTH SIZE:</b> _____ FT. X _____ FT. = _____ SQ. FT.	\$1.08	\$1.51	
--	--------	--------	--

### PROTECTIVE PLASTIC COVERING - PRICE PER SQ. FT. INSTALLED (STANDARD SIZES ONLY) - PRICING IS FOR INSTALLATION ONLY. EXHIBITOR IS RESPONSIBLE FOR REMOVAL.

<b>BOOTH SIZE:</b> _____ FT. X _____ FT. = _____ SQ. FT.	\$0.24	\$0.33	
--	--------	--------	--

**PLEASE SELECT ONE FOR STANDARD OR CUSTOM SIZE CARPETS**

IF ORDERING ELECTRICAL OR TELECOMMUNICATIONS SERVICES, WILL UNDER CARPET WIRING BE REQUIRED?

YES       NO

#### TERMS AND CONDITIONS

- ALL ORDERS RECEIVED AFTER DISCOUNT PRICE DATE WILL BE PROCESSED AT THE REGULAR PRICE.
- EXHIBITOR IS RESPONSIBLE FOR ALL ITEMS FOR THE DURATION OF THE SHOW.
- NO REFUNDS/EXCHANGES ON CARPETS ONCE DELIVERED.
- CHARGES ARE FOR RENTAL OF EQUIPMENT ONLY. ALL ITEMS REMAIN THE PROPERTY OF GES.
- ALL CLAIMS OR DISCREPANCIES MUST BE SETTLED AT THE GES SERVICE CENTRE PRIOR TO SHOW CLOSING.
- IF A COLOUR IS NOT CHOSEN, GES WILL CHOOSE A COLOUR FOR YOU. CARPET COLOUR SUBJECT TO AVAILABILITY

<b>SUBTOTAL</b>	
<b>GST 5%</b>	
<b>TOTAL</b>	
<b>INCLUDE TOTAL FROM THIS PAGE ON ORDER CHECKLIST SHEET</b>	

I HAVE READ AND UNDERSTAND THE TERMS & CONDITIONS OF MY AGREEMENT WITH GES.

\_\_\_\_\_  
SIGNATURE

\_\_\_\_\_  
DATE





7730 - 34 Street NW, Edmonton, AB T6B 3J6 Phone: 780.469.7767 Fax: 780.469.1619 Toll Free: 877.505.7767 edmonton@ges.com

# BOOTH CLEANING ORDER FORM

**SHOW NAME:** **The Edmonton Boat & Sportsmen's Show**  
**SHOW DATE:** **March 16 - 19, 2017**

**DISCOUNT PRICE DEADLINE DATE:** **Monday, February 27, 2017**

**EXHIBITOR INFORMATION**

**CREDIT CARD AUTHORIZATION**

**BOOTH #:** \_\_\_\_\_

**COMPANY:** \_\_\_\_\_

**STREET:** \_\_\_\_\_

**CITY:** \_\_\_\_\_ **PROV/STATE:** \_\_\_\_\_ **CODE:** \_\_\_\_\_

**EMAIL:** \_\_\_\_\_

**PHONE:** \_\_\_\_\_ **FAX:** \_\_\_\_\_

**CONTACT NAME:** \_\_\_\_\_

**NO ORDER WILL BE CONSIDERED FINAL UNTIL CREDIT CARD AUTHORIZATION FORM IS COMPLETED AND SUBMITTED WITH THIS FORM.**

**ALL ORDERS MUST BE PREPAID IN FULL  
(ORDERS CANNOT BE PROCESSED UNTIL PAYMENT IS RECEIVED)**

PLEASE NOTE: CARPET WILL BE INSTALLED CLEAN, SHOULD EXHIBITOR REQUIRE ADDITIONAL CLEANING AFTER SETUP, AN INITIAL CLEANING FEE WILL APPLY.

INITIAL CLEANING SERVICES	DAILY CLEANING SERVICES	ADDITIONAL CLEANING SERVICES
COMPLETED EVENING PRIOR TO SHOW OPENING	COMPLETED PRIOR TO SHOW OPENING AND EVERY NIGHT AT SHOW CLOSE DURING THE DURATION OF THE SHOW	COMPLETED UPON REQUEST
CARPETS VACUUMED  WASTEBASKETS EMPTIED	CARPETS VACUUMED  WASTEBASKETS EMPTIED	FOR CARPET IN NEED OF SPECIAL ATTENTION DUE TO FOOD SAMPLING, DEMONSTRATIONS, HAIR, WOOD, METAL SHAVINGS, GREASE OR PAINT.

RATES / SQ.FT.		RATES / SQ.FT.			RATES / SQ.FT.	
DISCOUNT PRICE	REGULAR PRICE	BOOTH SQ. FT	DISCOUNT PRICE	REGULAR PRICE	DISCOUNT PRICE	REGULAR PRICE
\$0.40	\$0.56	50 - 600 SQ.FT.	\$0.57	\$0.80	CALL FOR QUOTATION	N/A
		601 - 1000 SQ.FT.	\$0.48	\$0.67		
		OVER 1000 SQ.FT.	\$0.40	\$0.56		

**SELECT SERVICE REQUIRED:**

Initial Cleaning       Daily Cleaning       Additional Services

\_\_\_\_\_ @ \_\_\_\_\_ = \_\_\_\_\_

**Total Sq.Ft. of Booth**      **Price per sq.ft.**      **Total**

**TERMS AND CONDITIONS**

- ALL ORDERS RECEIVED AFTER DISCOUNT PRICE DATE WILL BE PROCESSED AT THE REGULAR PRICE.
- NO CANCELLATIONS AFTER MOVE-IN BEGINS.
- ALL CLAIMS OR DISCREPANCIES MUST BE SETTLED AT THE GES SERVICE CENTRE PRIOR TO SHOW CLOSING.
- ALL ORDERS ARE GOVERNED BY GES LIMITS OF LIABILITY AND RESPONSIBILITY.

<b>SUBTOTAL</b>	
<b>GST 5%</b>	
<b>TOTAL</b>	
<b>INCLUDE TOTAL FROM THIS PAGE ON ORDER CHECKLIST SHEET</b>	

I HAVE READ AND UNDERSTAND THE TERMS & CONDITIONS OF MY AGREEMENT WITH GES.

\_\_\_\_\_  
SIGNATURE

\_\_\_\_\_  
DATE

**MODULAR EXHIBIT SYSTEM  
SHOW SPECIAL  
ORDER FORM**

<b>SHOW NAME:</b>	<b>The Edmonton Boat &amp; Sportsmen's Show</b>	<b>DISCOUNT PRICE</b>	
<b>SHOW DATE:</b>	<b>March 16 - 19, 2017</b>	<b>DEADLINE DATE:</b>	<b>Monday, February 27, 2017</b>
<b>EXHIBITOR INFORMATION</b>		<b>CREDIT CARD AUTHORIZATION</b>	

**BOOTH #:** \_\_\_\_\_

COMPANY: \_\_\_\_\_

STREET: \_\_\_\_\_

CITY: \_\_\_\_\_ PROV/STATE: \_\_\_\_\_ CODE: \_\_\_\_\_

EMAIL: \_\_\_\_\_

PHONE: \_\_\_\_\_ FAX: \_\_\_\_\_

CONTACT NAME: \_\_\_\_\_

**NO ORDER WILL BE CONSIDERED  
FINAL UNTIL CREDIT CARD  
AUTHORIZATION FORM IS COMPLETED  
AND SUBMITTED WITH THIS FORM**

**ALL ORDERS MUST BE PREPAID IN FULL  
(ORDERS CANNOT BE PROCESSED UNTIL PAYMENT IS RECEIVED)**

**SHOW SPECIAL !**

**➔ SPEND LESS      ➔ SELL MORE      ➔ LOOK GREAT**

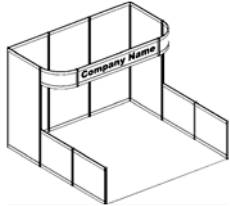

- INSTALLED & DISMANTLED
- READY BEFORE YOU ARRIVE
- NO LABOUR COSTS
- NO TRUCKING COSTS
- NO MATERIAL HANDLING COSTS
- INCLUDES CARPET
- INCLUDES HEADER SIGN(S)
- WHITE PANELS
- ACCESSORIES AVAILABLE

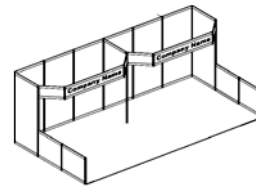

<b>DISCOUNT PRICE</b>	<b>\$1,000.50</b>
<b>PACKAGE A: 10' X 10' BOOTH INCLUDES:</b>	
- HEADER SIGN 11.25" X 116.25"	
- COLOR COORDINATED 10' X 10' CARPET	
<b>REGULAR PRICE</b>	<b>\$1,400.50</b>

<b>DISCOUNT PRICE</b>	<b>\$1,557.50</b>
<b>PACKAGE B: 10' X 20' BOOTH INCLUDES:</b>	
- 2 HEADER SIGNS 11.25" X 116.25"	
- COLOR COORDINATED 10' X 20' CARPET	
<b>REGULAR PRICE</b>	<b>\$2,180.50</b>

INDICATE DATE AND TIME YOU PLAN TO ARRIVE TO MERCHANDISE YOUR EXHIBIT \_\_\_\_\_ DATE \_\_\_\_\_ TIME \_\_\_\_\_

**PLEASE COMPLETE THE FOLLOWING:**

SIZE ORDERED:  PACKAGE A (10 X 10)  PACKAGE B (10 X 20)

CARPET COLOUR:  BLACK  GREY  BLUE

GREEN  RED

PACKAGE A IDENTIFICATION SIGN TO READ: \_\_\_\_\_

PACKAGE B IDENTIFICATION SIGNS TO READ: LEFT: \_\_\_\_\_ RIGHT: \_\_\_\_\_

CUSTOM HEADER TO BE ADDED CUSTOM HEADER SIGNS/LOGOS ARE \$60.00 BEFORE DEADLINE AND \$100.00 PER SIGN IF ORDERED AFTER DEADLINE DATE.

**PLEASE UPLOAD GRAPHIC FILES TO: <http://file.ges.com>**

ALL CARPET COLOURS SUBJECT TO AVAILABILITY. CARPET WILL BE INSTALLED CLEAN, SHOULD EXHIBITOR REQUIRE ADDITIONAL CLEANING AFTER SETUP, AN INITIAL CLEANING FEE WILL APPLY.

**TERMS AND CONDITIONS**

- DOES NOT INCLUDE LIGHTING OR ELECTRICAL SERVICE.
- NO REFUNDS/EXCHANGES ONCE SHOW MOVE-IN BEGINS.
- ALL CLAIMS OR DISCREPANCIES MUST BE SETTLED AT THE GES SERVICE CENTRE PRIOR TO SHOW CLOSING.
- ALL ORDERS RECEIVED AFTER DISCOUNT PRICE DATE WILL BE PROCESSED AT THE REGULAR PRICE.
- GES IS NOT RESPONSIBLE FOR EXHIBIT MATERIALS LEFT IN MODULAR EXHIBIT SYSTEM OR COUNTER STORAGE UNITS.
- CHANGES TO THE STRUCTURE DESIGN OR GRAPHICS WILL RESULT IN ADDITIONAL FEES.
- EXHIBITOR IS RESPONSIBLE FOR ALL ITEMS DURING THE DURATION OF THE SHOW.

**I HAVE READ AND UNDERSTAND THE TERMS & CONDITIONS OF MY AGREEMENT WITH GES.**

<b>SUBTOTAL</b>	
<b>GST 5%</b>	
<b>TOTAL</b>	

**INCLUDE TOTAL FROM THIS PAGE  
ON ORDER CHECKLIST SHEET**

\_\_\_\_\_  
SIGNATURE

\_\_\_\_\_  
DATE





# standard exhibit rentals

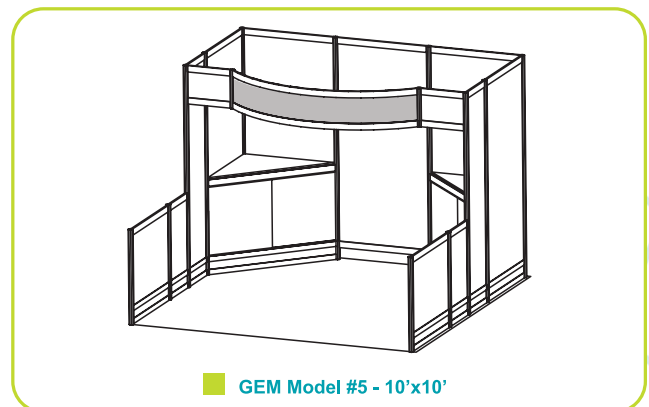
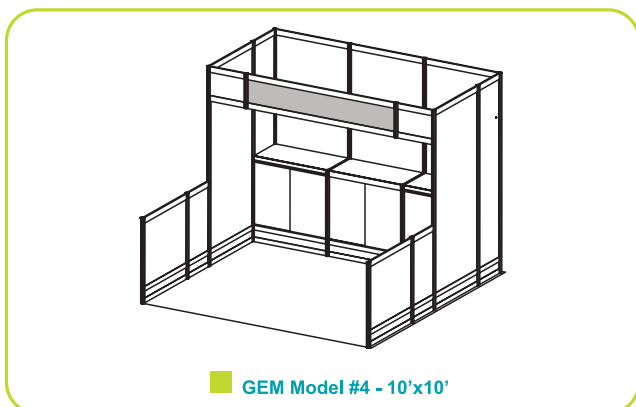
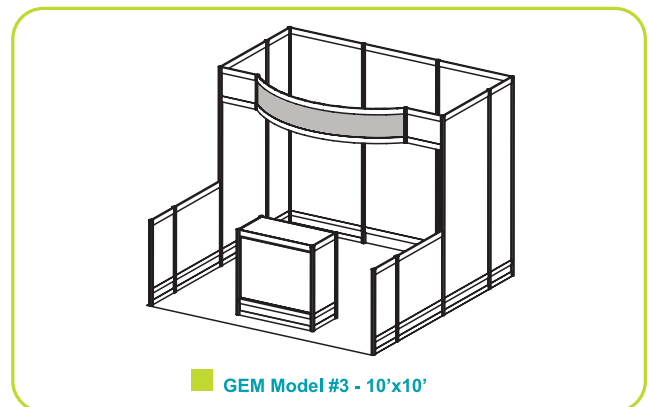
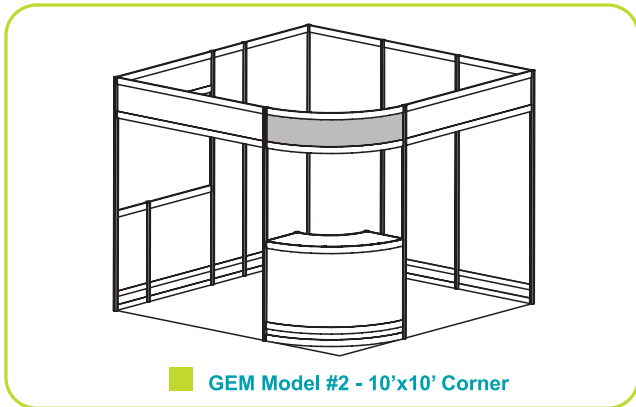
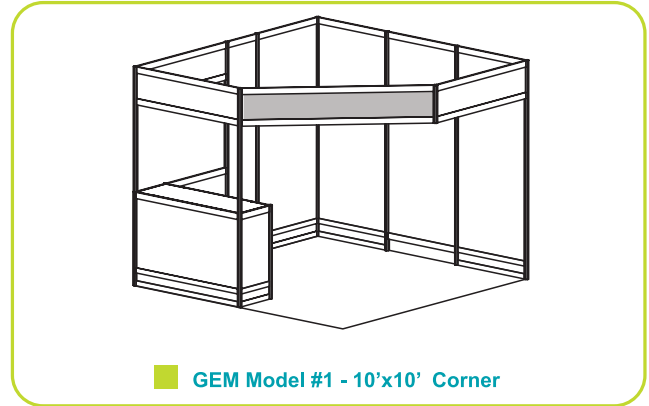

## 3 Easy Steps

- 1 Select the model number that suits your needs
- 2 Choose carpet and panel colours on the GEM Exhibit Rental order form
- 3 Complete & send order form

Grey indicates standard header sign(s)



**GES** *Global Experience Specialists*

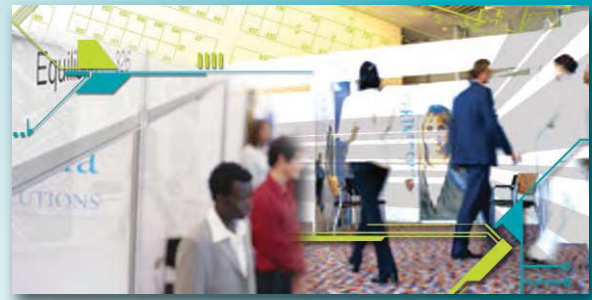

# standard exhibit rentals

**10' X 20'**

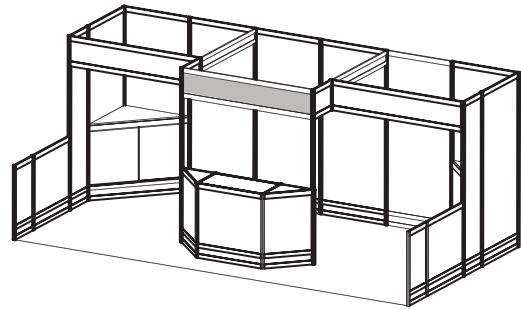

GEM Model #6 - 10'x20'

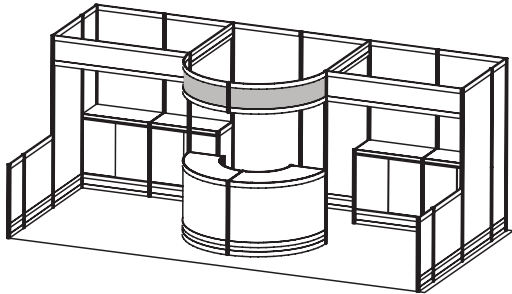

GEM Model #7 - 10'x20'

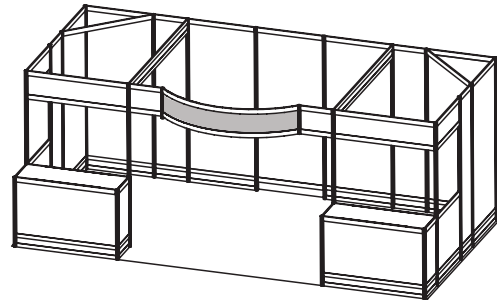

GEM Model #8 - 10'x20'

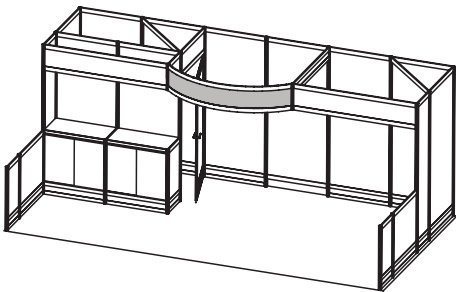

GEM Model #9 - 10'x20'

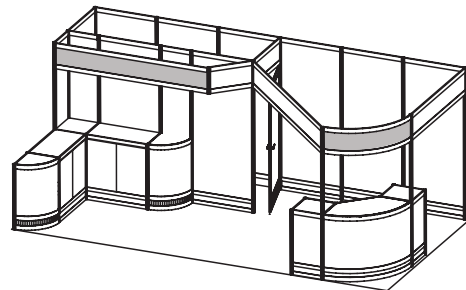

GEM Model #10 - 10'x20' Corner

## 3 Easy Steps →

- 1 Select the model number that suits your needs
- 2 Choose carpet and panel colours on the GEM Exhibit Rental order form
- 3 Complete & send order form

Grey indicates standard header sign(s)



7730 - 34 Street NW, Edmonton, AB T6B 3J6 Phone: 780.469.7767 Fax: 780.469.1619 Toll Free: 877.505.7767 edmonton@ges.com

# MODULAR EXHIBIT SYSTEM ORDER FORM

**SHOW NAME:** The Edmonton Boat & Sportsmen's Show  
**SHOW DATE:** March 16 - 19, 2017

**DISCOUNT PRICE DEADLINE DATE:** Monday, February 27, 2017

**EXHIBITOR INFORMATION**

**CREDIT CARD AUTHORIZATION**

**BOOTH #:** \_\_\_\_\_  
**COMPANY:** \_\_\_\_\_  
**STREET:** \_\_\_\_\_  
**CITY:** \_\_\_\_\_ **PROV/STATE:** \_\_\_\_\_ **CODE:** \_\_\_\_\_  
**EMAIL:** \_\_\_\_\_  
**PHONE:** \_\_\_\_\_ **FAX:** \_\_\_\_\_  
**CONTACT NAME:** \_\_\_\_\_

NO ORDER WILL BE CONSIDERED FINAL UNTIL CREDIT CARD AUTHORIZATION FORM IS COMPLETED AND SUBMITTED WITH THIS FORM

**ALL ORDERS MUST BE PREPAID IN FULL (ORDERS CANNOT BE PROCESSED UNTIL PAYMENT IS RECEIVED)**

MODEL NUMBER	DISCOUNT PRICE	REGULAR PRICE	MODEL NUMBER	DISCOUNT PRICE	REGULAR PRICE
Model #1 - 10x10 Corner	\$1,181.00	\$1,653.50	Model #6 - 10x20 Inline	\$2,344.50	\$3,282.50
Model #2 - 10x10 Corner	\$1,269.50	\$1,777.50	Model #7 - 10x20 Inline	\$3,002.00	\$4,203.00
Model #3 - 10x10 Inline	\$1,359.50	\$1,903.00	Model #8 - 10x20 Inline	\$2,512.50	\$3,517.50
Model #4 - 10x10 Inline	\$1,616.00	\$2,262.00	Model #9 - 10x20 Inline	\$2,779.50	\$3,891.00
Model #5 - 10x10 Inline	\$1,727.00	\$2,418.00	Model #10 - 10x20 Corner	\$3,370.00	\$4,718.00

**Package Includes :** Installation & Dismantling, Choice of Carpet Colour, Choice of Panel Colour, Company Identification Sign

**PACKAGE DOES NOT INCLUDE:** Cleaning, Light Fixtures or Electrical Outlets

**PLEASE COMPLETE THE FOLLOWING:**

**Model Number**

*Upgrade options available. Contact Exhibitor Services.*

**FONT COLOUR:**  BLACK  
**INFILL PANEL COLOUR:**  BLACK  GREY  WHITE  BLUE  RED  
**CARPET COLOUR:**  BLACK  GREY  BLUE  GREEN  RED

MODELS 1, 2, 3, 4, 5, 6, 8 OR 9 IDENTIFICATION SIGN TO READ: \_\_\_\_\_

MODELS 7 OR 10 IDENTIFICATION SIGN TO READ: LEFT: \_\_\_\_\_ RIGHT: \_\_\_\_\_

INDICATE DATE & TIME FOR ARRIVAL: \_\_\_\_\_

**CUSTOM HEADER TO BE ADDED** CUSTOM HEADER SIGNS/LOGOS ARE \$60.00 BEFORE DEADLINE AND \$100.00 PER SIGN IF ORDERED AFTER DEADLINE DATE.

**ALL ORDERS MUST BE PREPAID IN FULL ( ORDERS CAN NOT BE PROCESSED UNTIL PAYMENT IS RECEIVED )**

**TERMS AND CONDITIONS**

PAYMENT MAY BE MADE BY CHEQUE UP TO TWO WEEKS PRIOR TO THE 1ST DAY OF MOVE IN.  
 ALL ORDERS RECEIVED AFTER THE DISCOUNT PRICE DATE WILL BE PROCESSED AT THE REGULAR PRICE.  
 EXHIBITOR IS RESPONSIBLE FOR ALL ITEMS FOR THE DURATION OF THE SHOW.  
 CHARGES ARE FOR RENTAL OF EQUIPMENT ONLY. ALL ITEMS REMAIN PROPERTY OF GES.  
 NO REFUNDS/EXCHANGES ONCE SHOW MOVE-IN BEGINS. ALL CLAIMS OR DISCREPENCIES MUST BE SETTLED PRIOR TO SHOW CLOSING.  
 GES IS NOT RESPONSIBLE FOR EXHIBIT MATERIALS LEFT IN MODULAR EXHIBIT SYSTEM OR COUNTER STORAGE UNITS.  
 CHANGES TO THE STRUCTURE DESIGN OR GRAPHICS WILL RESULT IN ADDITIONAL FEES.

<b>SUBTOTAL</b>	
<b>GST 5%</b>	
<b>TOTAL</b>	
<b>INCLUDE TOTAL FROM THIS PAGE ON ORDER CHECKLIST SHEET</b>	

**I HAVE READ AND UNDERSTAND THE TERMS & CONDITIONS OF MY AGREEMENT WITH GES.**

\_\_\_\_\_  
SIGNATURE

\_\_\_\_\_  
DATE

**MODULAR EXHIBIT SYSTEM  
ACCESSORIES  
ORDER FORM**

**SHOW NAME:** **The Edmonton Boat & Sportsmen's Show**  
**SHOW DATE:** **March 16 - 19, 2017**

**DISCOUNT PRICE DEADLINE DATE:** **Monday, February 27, 2017**

**EXHIBITOR INFORMATION**

**CREDIT CARD AUTHORIZATION**

**BOOTH #:** \_\_\_\_\_

COMPANY: \_\_\_\_\_

STREET: \_\_\_\_\_

CITY: \_\_\_\_\_ PROV/STATE: \_\_\_\_\_ CODE: \_\_\_\_\_

EMAIL: \_\_\_\_\_

PHONE: \_\_\_\_\_ FAX: \_\_\_\_\_

CONTACT NAME: \_\_\_\_\_

**NO ORDER WILL BE CONSIDERED  
FINAL UNTIL CREDIT CARD  
AUTHORIZATION FORM IS  
COMPLETED AND SUBMITTED WITH  
THIS FORM**

**ALL ORDERS MUST BE PREPAID IN FULL  
(ORDERS CANNOT BE PROCESSED UNTIL PAYMENT IS RECEIVED)**

QTY	#	DESCRIPTION	DISCOUNT	REGULAR	TOTAL				
	1	Pedestal 20"L x 20"W 28"H OR 36"H	\$91.50	\$128.00					
	2	Pedestal 40"L x 40"W	\$458.50	\$642.00					
	3	Storage Counter 40"L X 20"W X 40"H	\$139.50	\$195.50		1			
	4	Storage Counter 80"L x 20"W x 40"H	\$272.50	\$381.50					
	5	Curved Counter 60"L x 20"W x 40"H	\$187.00	\$262.00					
	6	99A Showcase 36"L x 20"W x 40"H	\$187.00	\$262.00					
	7	99B Showcase 36"L x 20"W x 40"H	\$190.50	\$266.50					
	8	99C Showcase 26"L x 26"W x 96"H	\$276.00	\$386.00					
	9	99D Showcase 40"L x 20"W x 96"H	\$390.00	\$546.00					
QTY	#	DESCRIPTION	DISCOUNT	REGULAR	TOTAL				
	A	Waterfall with Eight Balls	\$18.50	\$25.50					
	B	Grid Panels - 38" W x 44"H Panels	\$128.00	\$179.50					
	C	Garment Rail 39"W	\$47.50	\$66.50					
	D	Shelves, Flat or Angled 37"L x 12"W	\$40.00	\$56.00					
	E	Slatwall Panels - 37"W x 96"H Grey	\$110.50	\$154.50					
ADDITIONAL ITEMS NOT SHOWN									
		Ballot Bin - 20"L X 20"W X 36"H	\$120.00	\$168.00					
		Computer Counter	\$158.00	\$221.00					

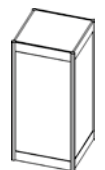

1

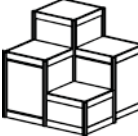

2

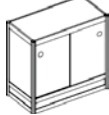

3

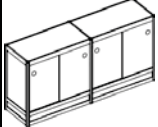

4



5



6



7

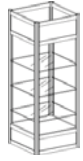

8



9



A



B



C



D



E

**Accessories A to E are designed to fit  
GES Hardwall Only**

**All Units Include White Panels**

**Please attach diagram of booth indicating locations for grid panels and /  
or slatwall. Grid panels CANNOT be installed in corners.**

**TERMS AND CONDITIONS**

- DOES NOT INCLUDE LIGHTING OR ELECTRICAL SERVICE.
- NO REFUNDS/EXCHANGES ONCE SHOW MOVE-IN BEGINS.
- ALL CLAIMS OR DISCREPANCIES MUST BE SETTLED AT THE GES SERVICE CENTRE PRIOR TO SHOW CLOSING.
- ALL ORDERS RECEIVED AFTER DISCOUNT PRICE DATE WILL BE PROCESSED AT THE REGULAR PRICE.
- GES IS NOT RESPONSIBLE FOR EXHIBIT MATERIALS LEFT IN MODULAR EXHIBIT SYSTEM OR COUNTER STORAGE UNITS.
- CHANGES TO THE STRUCTURE DESIGN OR GRAPHICS WILL RESULT IN ADDITIONAL FEES.
- EXHIBITOR IS RESPONSIBLE FOR ALL ITEMS DURING THE DURATION OF THE SHOW.

I HAVE READ AND UNDERSTAND THE TERMS & CONDITIONS OF MY AGREEMENT WITH GES.

<b>SUBTOTAL</b>	
<b>GST 5%</b>	
<b>TOTAL</b>	
<b>INCLUDE TOTAL FROM THIS PAGE ON ORDER CHECKLIST SHEET</b>	

SIGNATURE

DATE

GES is your one stop exhibit solution partner. Take advantage of our Creative Services Department to enhance your presence on the show floor. Upgrade a show special, or design from scratch. Our team of in-house Designers & Production Technicians, can help you realize your vision quickly and affordably.



- Backlit signs
- Banners & hanging signs
- Floor/carpet decals
- Backwall murals
- Easel & freestanding signs
- Posters
- Custom cut signs & decals
- Branding graphics

Please contact **Melissa Mitchell**: 780.577.4538 or email: [mmitchell@ges.com](mailto:mmitchell@ges.com)

Please upload files to: <https://file.ges.com/>  
(file must be eps, ai, pdf or psd: fonts must be supplied or converted to outlines)





7730 - 34 Street NW, Edmonton, AB T6B 3J6 Phone: 780.469.7767 Fax: 780.469.1619 Toll Free: 877.505.7767 edmonton@ges.com

# GRAPHICS ORDER FORM

**SHOW NAME:** **The Edmonton Boat & Sportsmen's Show**  
**SHOW DATE:** **March 16 - 19, 2017**

**DISCOUNT PRICE DEADLINE DATE:** **Monday, February 27, 2017**

**EXHIBITOR INFORMATION**

**BOOTH #:** \_\_\_\_\_

**COMPANY:** \_\_\_\_\_

**STREET:** \_\_\_\_\_

**CITY:** \_\_\_\_\_ **PROV/STATE:** \_\_\_\_\_ **CODE:** \_\_\_\_\_

**EMAIL:** \_\_\_\_\_

**PHONE:** \_\_\_\_\_ **FAX:** \_\_\_\_\_

**CONTACT NAME:** \_\_\_\_\_

**CREDIT CARD AUTHORIZATION**

NO ORDER WILL BE CONSIDERED FINAL UNTIL CREDIT CARD AUTHORIZATION FORM IS COMPLETED AND SUBMITTED WITH THIS FORM

ALL ORDERS MUST BE PREPAID IN FULL  
 (ORDERS CANNOT BE PROCESSED UNTIL PAYMENT IS RECEIVED)

SIGN LAYOUT	QTY	SIGN SIZES	DISCOUNT PRICE	REGULAR PRICE
<p style="font-size: small;">Width Height Inches Wide By Inches High</p>		11" x 14"	\$45.50	\$63.50
		14" x 22"	\$64.00	\$89.50
		22" x 28"	\$99.50	\$139.50
		7" x 44"	\$64.00	\$89.50
		28" x 44"	\$170.50	\$238.50
		40" x 60"	\$259.50	\$363.50
			Layout & Design Work / Hour	\$67.00

CUSTOM ARTWORK / LOGOS MUST BE ORDERED NO LATER THAN 5 BUSINESS DAYS PRIOR TO FIRST DAY OF MOVE-IN

PLEASE PRINT OR TYPE THE TEXT REQUIRED:

**PLEASE INDICATE FONT TYPE:** \_\_\_\_\_

ALL SIGNS MUST BE PICKED UP FROM OUR ON-SITE EXHIBITOR SERVICES DESK  
 Custom sizes available - Call for quotation.  
TERMS AND CONDITIONS

ALL ORDERS RECEIVED AFTER THE DISCOUNT PRICE DATE WILL BE PROCESSED AT THE REGULAR PRICE.  
 THERE ARE NO REFUNDS / EXCHANGES ON SIGNS UNLESS ERROR LIES WITH GES PRODUCTION.  
 NO REFUNDS/EXCHANGES ONCE SHOW MOVE-IN BEGINS. ALL CLAIMS OR DISCREPENCIES MUST BE SETTLED PRIOR TO SHOW CLOSING.

**Please upload Graphics to <https://file.ges.com/>**

<b>SUBTOTAL</b>	
<b>GST 5%</b>	
<b>TOTAL</b>	
INCLUDE TOTAL FROM THIS PAGE ON ORDER CHECKLIST SHEET	

I HAVE READ AND UNDERSTAND THE TERMS & CONDITIONS OF MY AGREEMENT WITH GES.

\_\_\_\_\_  
SIGNATURE

\_\_\_\_\_  
DATE

# LABOUR SERVICE ORDER FORM

<b>SHOW NAME:</b>	<b>The Edmonton Boat &amp; Sportsmen's Show</b>	<b>DISCOUNT PRICE DEADLINE DATE:</b>	Monday, February 27, 2017
<b>SHOW DATE:</b>	<b>March 16 - 19, 2017</b>	<b>EXHIBITOR INFORMATION</b>	

<b>BOOTH #:</b> _____  COMPANY: _____ STREET: _____ CITY: _____ PROV/STATE: _____ CODE: _____ EMAIL: _____ PHONE: _____ FAX: _____ CONTACT NAME: _____	<b>NO ORDER WILL BE CONSIDERED FINAL UNTIL CREDIT CARD AUTHORIZATION FORM IS COMPLETED AND SUBMITTED WITH THIS FORM</b>
---	---

**ALL ORDERS MUST BE PREPAID IN FULL (ORDERS CANNOT BE PROCESSED UNTIL PAYMENT IS RECEIVED)**

LABOUR RATES LISTED ARE PER PERSON PER HOUR AT A MINIMUM CHARGE OF ONE (1) HOUR. LABOUR OVER ONE (1) HOUR IS CHARGED IN HALF (1/2) HOUR INCREMENTS.  
**A 40% SURCHARGE WILL BE APPLIED TO ONSITE ORDERS**

**STRAIGHT TIME**  
 Monday - Friday  
 8:00am - 4:00pm

**DISCOUNT PRICE:**  
\$72.50

**REGULAR PRICE:**  
\$101.50

**OVERTIME**  
 Monday - Friday  
 4:00pm - 8:00am  
 Saturday - Sunday

**DISCOUNT PRICE:**  
\$108.50

**REGULAR PRICE:**  
\$152.00

**EXHIBITOR MUST REPORT TO GES SERVICE CENTRE TO RECEIVE THEIR LABOUR**

<b>INSTALLATION</b>	Set up Drawings or Photos Attached: <input type="checkbox"/> YES <input type="checkbox"/> NO		
Carrier: _____	Delivery Date: _____ <small>(Day/Date/Month/Year)</small>	Delivery time: _____ <small>(indicate am or pm)</small>	
<b>SUPERVISION</b>	<input type="checkbox"/> By Exhibitor (Provide Name of Rep) _____ <small>(Exhibitor MUST be Present to Supervise)</small>	<input type="checkbox"/> By GES (30% Surcharge Applies) _____ <small>(Exhibitor Does not have to be present)</small>	
Date Labour Required: _____ <small>(Day/ Date/Month/Year)</small>	Start time Required: _____	<input type="checkbox"/> AM <input type="checkbox"/> PM	
Number of People Required: <input style="width: 40px;" type="text"/>	X Hours Per Person <input style="width: 40px;" type="text"/>	= Total Hours <input style="width: 40px;" type="text"/>	

<b>DISMANTLING</b>	Carrier: _____		
	Delivery Date: _____ <small>(Day/Date/Month/Year)</small>	Delivery time: _____ <small>(indicate am or pm)</small>	
<b>SUPERVISION</b>	<input type="checkbox"/> By Exhibitor (Provide Name of Rep) _____ <small>(Exhibitor MUST be Present to Supervise)</small>	<input type="checkbox"/> By GES (30% Surcharge Applies) _____ <small>(Exhibitor Does not have to be present)</small>	
Date Labour Required: _____ <small>(Day/ Date/Month/Year)</small>	Start time Required: _____	<input type="checkbox"/> AM <input type="checkbox"/> PM	
Number of People Required: <input style="width: 40px;" type="text"/>	X Hours Per Person <input style="width: 40px;" type="text"/>	= Total Hours <input style="width: 40px;" type="text"/>	

**TERMS AND CONDITIONS**

WHEN EXHIBITOR IS SUPERVISING LABOUR THE EXHIBITOR MUST CHECK LABOUR IN AND OUT AT THE GES SERVICE CENTRE.  
 WE RESERVE THE RIGHT TO CHANGE LABOURERS AND/OR RATES AS SHIFTS CHANGE.  
 ALL CLAIMS OR DISCREPANCIES MUST BE SETTLED AT THE GES SERVICE CENTRE PRIOR TO SHOW CLOSING.  
 UNCANCELLED LABOUR WILL BE CHARGED A MINIMUM FEE OF 1 HOUR PER PERSON.  
 GES LIMITS OF LIABILITY APPLY

<b>SUBTOTAL</b>	
<b>GST 5%</b>	
<b>TOTAL</b>	
<b>INCLUDE TOTAL FROM THIS PAGE ON ORDER CHECKLIST SHEET</b>	

I HAVE READ AND UNDERSTAND THE TERMS & CONDITIONS OF MY AGREEMENT WITH GES.

\_\_\_\_\_  
 SIGNATURE DATE



# IN-BOOTH FORKLIFT SERVICE ORDER FORM

<b>SHOW NAME:</b>	<b>The Edmonton Boat &amp; Sportsmen's Show</b>	<b>DISCOUNT PRICE DEADLINE DATE:</b>	Monday, February 27, 2017
<b>SHOW DATE:</b>	<b>March 16 - 19, 2017</b>		

EXHIBITOR INFORMATION	CREDIT CARD AUTHORIZATION
<p><b>BOOTH #:</b> _____</p> <p>COMPANY: _____</p> <p>STREET: _____</p> <p>CITY: _____ PROV/STATE: _____ CODE: _____</p> <p>EMAIL: _____</p> <p>PHONE: _____ FAX: _____</p> <p>CONTACT NAME: _____</p>	<p><b>NO ORDER WILL BE CONSIDERED FINAL UNTIL CREDIT CARD AUTHORIZATION FORM IS COMPLETED AND SUBMITTED WITH THIS FORM</b></p>

**CREDIT CARD AUTHORIZATION (ABOVE) MUST BE COMPLETED AS METHOD OF PAYMENT FOR THIS SERVICE**

IN-BOOTH FORKLIFT SERVICE IS AVAILABLE TO EXHIBITORS REQUIRING ASSISTANCE WITH POSITIONING OF EXHIBITORS MATERIAL **WITHIN YOUR YOUR BOOTH SPACE**. **MINIMUM CHARGE OF ONE HOUR** PER SHIPMENT **PER FORKLIFT DRIVER**. SERVICES OVER ONE (1) HOUR WILL BE CHARGED IN HALF (1/2) HOUR INCREMENTS (INCLUDES MOVE-IN AND MOVE-OUT)

**THIS SERVICE IS NOT PAID FOR BY SHOW MANAGEMENT**

ALL RATES INCLUDE ONE (1) FORKLIFT AND DRIVER - ADDITIONAL RATES WILL APPLY FOR ADDITIONAL PERSONNEL AND EQUIPMENT

<b>STRAIGHT TIME</b> Monday - Friday 8:00am - 4:00pm	DISCOUNT PRICE: \$110.50  REGULAR PRICE: \$154.50	<b>OVERTIME</b> Monday - Friday 4:00pm-8:00am Saturday - Sunday	DISCOUNT PRICE: \$165.50  REGULAR PRICE: \$231.50
--	---	--	---

**A 40% SURCHARGE WILL APPLY TO ALL AFTER DEADLINE ORDERS**

**ALL RATES INCLUDE FORKLIFT AND DRIVER (5% GST IS APPLICABLE)**

PLEASE COMPLETE THE FOLLOWING

EXHIBITOR MUST BE PRESENT TO SUPERVISE SUPERVISOR NAME: \_\_\_\_\_

TIMES ARE APPROXIMATE ONLY WILL BE DISPATCHED UPON REQUEST PLACED AT GES SERVICE DESK ON SHOW-SITE FORKLIFTS

**MOVE-IN REQUIREMENTS**

DAY	DATE	# OF HOURS	# OF FORKLIFTS

PREFERRED INSTILLATION TIME: \_\_\_\_\_ AM / PM \_\_\_\_\_ AM / PM

START TIME	FINSISH TIME

**MOVE-OUT REQUIREMENTS**

DAY	DATE	# OF HOURS	# OF FORKLIFTS

PREFERRED DISMANTLE TIME: \_\_\_\_\_ AM / PM \_\_\_\_\_ AM / PM

START TIME	FINISH TIME

**SERVICES OVER 1 HOUR MINIMUM WILL BE CHARGED IN 1/2 HOUR INCREMENTS PER FORKLIFT**

- TERMS AND CONDITIONS**
- EXHIBITOR MUST CHECK FORKLIFT / DRIVER IN AND OUT AT THE GES SERVICE CENTRE.
  - WE RESERVED THE RIGHT TO CHANGE LABOURERS AND / OR RATES AS SHIFTS CHANGE.
  - FORKLIFT OPERATORS RESERVE THE RIGHT TO REFUSE UNSAFE REQUESTS OR LIFTS AT ALL TIMES.
  - IT IS THE EXHIBITORS RESPONSIBILITY TO SECURE AND MAINTAIN LOSS & DAMAGE INSURANCE COVERAGE FOR THEIR EXHIBIT PROPERTIES.
  - ALL CLAIMS OR DISCREPANCIES MUST BE SETTLED AT THE GES SERVICE CENTRE PRIOR TO SHOW CLOSING
  - GES LIMITS OF LIABILITY & RESPONSIBILITY APPLY TO THIS SERVICE.

<b>SUBTOTAL</b>	
<b>GST 5%</b>	
<b>TOTAL</b>	
<b>INCLUDE TOTAL FROM THIS PAGE ON ORDER CHECKLIST SHEET</b>	

I HAVE READ AND UNDERSTAND THE TERMS & CONDITIONS OF MY AGREEMENT WITH GES.

\_\_\_\_\_  
SIGNATURE \_\_\_\_\_  
DATE

**What is material handling?**

Material Handling is the unloading of your exhibit materials, delivery to your booth, handling of empty containers to and from storage, and removal of your materials from your booth for reloading onto your outbound carrier. This is not to be confused with the cost to transport your exhibit material to and from the event.

**What types of material handling do you offer?**

Depending on the show and facility, we can provide:

**Advanced Show Storage**

*(you schedule your carrier to ship to our warehouse ahead of time and we bring your shipment to showsite and deliver it to your booth prior to your arrival)*

**Direct to Showsite**

*(you schedule your carrier to deliver directly to the showsite and we handle the unloading of your carrier and deliver your shipment to your booth)*

**Post Show Storage**

*(we bring your shipment from showsite back to our warehouse where you can schedule your carrier to come pick it up)*

**Advanced Show Storage**

**Benefits of Advance Shipping to the GES Warehouse**

- Storage of materials for up to 30 days prior to your show.
- Delivery of shipments to your booth by 8:00 AM on your first day of move-in (schedule permitting).
- Some convention centres and hotels do not have facilities for receiving or storing freight.
- Saves valuable set-up time.

**How to ship in Advance to the GES Warehouse**

- Contact your shipper of choice to schedule the shipment.
- Complete the Advanced show storage material handling order form.
- Remove all old shipping and empty storage labels.
- Fill out and attach enclosed Advance Shipping Labels.
- All shipments must have a bill of lading or delivery slip showing the number of pieces, weight, and type of merchandise.
- Take the time to ensure that your display and products are packed neatly and securely.
- Do not ship uncrated materials to the warehouse.

**Direct to Showsite Shipping**

**How to Ship to Exhibit Site**

- Consign all shipments c/o GES.
- Remove all old shipping and empty storage labels.
- Fill out and attach enclosed Direct Shipping labels.
- All shipments must have a bill of lading or delivery slip showing the number of pieces, weight, and type of merchandise.
- Take the time to ensure that your display and products are packed neatly and securely.
- If you are shipping your carpet and/or lighting trusses, make sure it is loaded last so it can be unloaded first.

**Post Show Storage**

**Benefits of Post Show Shipping to the GES Warehouse**

- Storage of materials for up to 3 business days after show close date.
- Scheduling carriers to pick up on a weekend or late night show tear out can be difficult
- Some convention centres and hotels do not have facilities for storing freight if it cant be picked up that night.
- Peace of mind knowing your shipment has been collected.
- Avoid forced freight charges.

**How to ship Post Show to the GES Warehouse**

- Complete the Post show storage material handling order form and send in before show.
- Remove all old shipping and empty storage labels.
- All shipments must have a bill of lading or delivery slip showing the number of pieces, weight, and type of merchandise.
- Take the time to ensure that your display and products are packed neatly and securely.
- Do not ship uncrated materials to the warehouse.
- Contact your carrier to pick up from GES Warehouse within 3 business days of show closing.

### **Freight Carriers**

Select a carrier with experience in handling exhibition materials. Make sure to give your carrier explicit information as to where and when to check-in. Delivery and pick up times are often out of the range of "normal" deliver hours, make sure your carrier is committed to meeting your target dates and times. While making shipping plans to the Show, also plan for the return shipment.

### **Tracking Shipments**

Confirm your delivery date and time with your carrier, and have all pertinent shipping information in the hands of your representative at showsite. You may also want to review the return of your goods prior to end of the show.

### **Estimating Material Handling Charges**

Handling charges are based on the weight of the freight. Shipments are billed by the hundred weight and rounded up to the nearest hundred. Minimum per shipment may apply, see enclosed Material Handling Order Form for details. Please prepay all shipping charges - GES cannot accept or be responsible for collect shipments. Crated and uncrated shipments must be separated and clearly identified on your bill of lading.

- **Crated** - Material that is skidded, or is any type of shipping container that can be unloaded at the dock with no additional handling required.
- **Uncrated** - Material that is shipped loose or pad-wrapped, and/or unskidded machinery without proper lifting bars or hooks.
- **Special Handling** - Defined as shipments that are loaded by cubic space and/or packed in such a manner as to require special handling, such as ground loading, side door loading, constricted space loading, and designated piece loading or stacked shipments. Also included are mixed shipments and shipments without proper delivery receipts.
- **Overtime Surcharges** - Shows that move-in or move-out on weekends or late in the day may be subject to overtime surcharges. See enclosed Material Handling Order Form for details.
- **Late Surcharges** - A surcharge may apply if advance freight is received after the published deadline date for shipments to arrive at the warehouse. See enclosed Material Handling Order Form for details.

### **Storing Empty Containers**

Properly labeled empty shipping cartons will be picked up, stored and returned after the show. Labels are available at the **GES Service centre** or from your GES Service Executive and are for empty storage only. Depending on the size of the show, it can take from one (1) to four (4) hours to return empty crates. Do not store any items in crates marked empty.

### **Outgoing Shipments**

An OMHF (Outbound Material Handling Form / Bill of Lading) must accompany all outgoing shipments. Shipping information, outbound forms and labels will be available at the **GES Service centre**. Exhibitors selecting non-official carriers will need to make their own arrangements for pickup. Make sure that someone from your company will be on-site to oversee the outbound shipment of your display and product.

### **Machinery Labour and Equipment**

Labour and equipment for uncrating, unskidding, positioning, leveling, dismantling, recrating, and reskidding machinery and/or equipment must be ordered separately. Place your order for this using the In-Booth Forklift and Labour Order Form. If your material requires specialized rigging equipment, please notify us promptly so that we can make arrangements. When possible supply your own rigging equipment with shipments and pre-rig your material

### **Insurance**

All of your goods should be insured by your own insurance policy. Although we do our best to handle your goods as our own, there are many variables in shipping and handling that can affect your exhibit and products. GES has published GES Terms & Conditions of Contract that are in your exhibitor service manual. Please read them carefully. It is recommended that your goods be insured.

### **Customs & Brokerage Fees**

GES is not responsible for the brokerage fees, duty or GST resulting from exhibitor materials entering Canada from another country. GES is not responsible for any delays in delivery of exhibitor materials to show site or the advance warehouse due to Canada Custom inspections or delays resulting from insufficient or improper documentation for shipments entering Canada from another country.

### **GES CANADA Limits of Liability**

- **Liability** - GES is liable for loss or damage to your goods ONLY if the loss or damage was caused by GES negligence.
  - **Measure of Damage** - If GES was negligent and the negligence caused either loss or damage to your goods, then the measure of that damage will be determined by the following:
    - a. Measure of damages in all situations (including b. below) will be limited by the Depreciated Value of the goods or repair costs, whichever is less.
    - b. The lesser of \$0.30 per pound per piece, \$50 per piece, or \$1000 per occurrence.
- GES does not offer or sell insurance. GES is not liable and will not owe for loss or damage to your goods if the damage was not caused by



7730 - 34 Street NW, Edmonton, AB T6B 3J6 Phone: 780.469.7767 Fax: 780.469.1619 Toll Free: 877.505.7767 edmonton@ges.com

# MATERIAL HANDLING ORDER FORM

**SHOW NAME:** The Edmonton Boat & Sportsmen's Show  
**SHOW DATE:** March 16 - 19, 2017

**DISCOUNT PRICE DEADLINE DATE:** Monday, February 27, 2017

**EXHIBITOR INFORMATION**

**CREDIT CARD AUTHORIZATION**

**BOOTH #:** \_\_\_\_\_  
**COMPANY:** \_\_\_\_\_  
**STREET:** \_\_\_\_\_  
**CITY:** \_\_\_\_\_ **PROV/STATE:** \_\_\_\_\_ **CODE:** \_\_\_\_\_  
**EMAIL:** \_\_\_\_\_  
**PHONE:** \_\_\_\_\_ **FAX:** \_\_\_\_\_  
**CONTACT NAME:** \_\_\_\_\_

**NO ORDER WILL BE CONSIDERED FINAL UNTIL CREDIT CARD AUTHORIZATION FORM IS COMPLETED AND SUBMITTED WITH THIS FORM**

**A 40% SURCHARGE WILL APPLY TO ALL ORDERS PLACED AFTER THE DEADLINE DATE**

**CREDIT CARD AUTHORIZATION (ABOVE) MUST BE COMPLETED AS METHOD OF PAYMENT FOR THIS SERVICE**

**ADVANCE SHIPMENT(S) TO WAREHOUSE:**

- Shipment(s) must be received by: Friday, March 10, 2017  
 - Estimated Weight of Shipment(s) - Rounded up to the nearest 100 lbs: \_\_\_\_\_ **POUNDS**  
 - Advance Warehouse Rate: **\$64.00** per 100 lbs. (200lb min. charge)  
 - Shipment(s) may arrive on or after: February 16, 2017

**POST SHOW STORAGE SERVICE:**

- Post Show Storage Rate of: **\$69.50** per 100 lbs. (200lb min. charge)  
 - This service includes transport back to the advance warehouse address only. \_\_\_\_\_ **POUNDS**  
 - **Shipments may be picked up starting on: Tuesday, March 21, 2017** \*Any shipments not picked up after 3 days will be considered forced freight and subject to additional storage charges.

**SPECIAL HANDLING: (40% Surcharge Applies to the Entire Shipment)**

- Shipments of loose, padded or uncrated materials.
- Special unloading requirements, such as ground and / or side door unloading, constricted or stacked unloading, shipments that need to be broken down.
- All Direct and Advance Shipments without certified weight ticket or proven inaccurate weight ticket.
- Shipments arriving outside of target dates.
- Services ordered after the deadline date.

**SMALL PACKAGES: (Maximum 50 lbs / Shipment)**

- Rate of: **\$41.00** for the First Package
  - Rate of: **\$10.50** for each additional package(s) (in the same shipment) to a 50lb. Maximum
- \*\*if shipment is over 50lbs, rates for advance or direct will apply.\*\*

**PLEASE COMPLETE THE FOLLOWING:**

**Carrier Name:** \_\_\_\_\_ **Number of Pieces:** \_\_\_\_\_ **Total Weight:** \_\_\_\_\_

**Important: Access to facilities varies from venue to venue, please contact GES to ensure your shipment does not exceed the maximum weight and dimensions.**

**Dimensions of pieces:** \_\_\_\_\_

**Date goods are scheduled to arrive:** \_\_\_\_\_ **Goods are scheduled for delivery to:**  Show Site  Warehouse

**TERMS AND CONDITIONS**

- COLLECT SHIPMENTS WILL NOT BE ACCEPTED.
- GES IS NOT RESPONSIBLE FOR CONCEALED DAMAGE, DAMAGE TO LOOSE OR INADEQUATELY PACKED SHIPMENTS OR LOSS OF MERCHANDISE AFTER DELIVERY TO BOOTH
- IT IS THE EXHIBITORS RESPONSIBILITY TO SECURE AND MAINTAIN LOSS & DAMAGE INSURANCE COVERAGE FOR THEIR EXHIBIT PROPERTIES.
- ALL CLAIMS OR DISCREPANCIES MUST BE SETTLED AT THE GES SERVICE CENTRE PRIOR TO SHOW CLOSING
- GES LIMITS OF LIABILITY & RESPONSIBILITY APPLY TO THIS SERVICE.

I HAVE READ AND UNDERSTAND THE TERMS & CONDITIONS OF MY AGREEMENT WITH GES.

<b>SUBTOTAL</b>	
<b>GST 5%</b>	
<b>TOTAL</b>	
<b>INCLUDE TOTAL FROM THIS PAGE ON ORDER CHECKLIST SHEET</b>	

\_\_\_\_\_  
SIGNATURE

\_\_\_\_\_  
DATE

# ADVANCE WAREHOUSE SHIPPING LABEL

NAME OF SHOW: The Edmonton Boat & Sportsmen's Show

FACILITY: Edmonton EXPO Centre

## EXHIBIT SHIPMENT FOR ADVANCE WAREHOUSE

**SHIPPER:**

\_\_\_\_\_  
(NAME OF COMPANY WHERE SHIPMENT ORIGINATES)

**TO:**

\_\_\_\_\_  
(NAME OF EXHIBITING COMPANY AT THE SHOW.)

**BOOTH #**

\_\_\_\_\_  
(BOOTH NUMBER AT THE SHOW.)

<b>ADVANCE WAREHOUSE ADDRESS</b>	Global Experience Specialists 7730 - 34th Street Edmonton, AB T6B 3J6
--	--

**CARRIER:**

\_\_\_\_\_  
(NAME OF TRANSPORTATION COMPANY)

NUMBER  OF  PIECES

ADVANCE WAREHOUSE SHIPMENTS SHOULD ARRIVE BEFORE:

Friday, March 10, 2017

**BETWEEN 9AM AND 4PM MONDAY - FRIDAY**



# logistics

## GES Logistic Services

*GES is proud  
to offer our  
clients a one  
source solution  
for  
Customs and  
Transportation  
services*

### Your Choice of Reliable Service Options

- Time Critical Ground
- Expedited Ground
- 3-5 Day Deferred
- Common Carrier
- Van Line

### 24-Hour Tracking

Call toll free 1-877-505-7767 for immediate information on the status of your shipment

### On-Site Representation

GES Logistics representatives will be on site from the beginning of move-in and throughout the event until the last shipment leaves the show floor

### Competitive Pricing

You will benefit from priority delivery at competitive prices thanks to special arrangements we have with select carriers

### Simplified Budgeting

Our transportation management system gives you the information you need to budget more effectively

### Simplified Ordering

For your convenience choose one of the ordering options available:

- Online: [www.gesexpo.ca](http://www.gesexpo.ca)
- Phone: 403-218-7428
- Fax: 403-243-3868

**Ship everywhere with GES Logistics Services.**





1. GES CANADA Exposition Services herein known as GES and its subcontractors shall not be responsible for damage to uncrated materials; materials improperly packed, glass breakage or concealed damage.

2. Relative to inbound shipments, there may be a lapse of time between the delivery of shipment(s) to the booth by GES or its subcontractors and the arrival of the Exhibitor's representative at the booth. Similarly, relative to outgoing shipment(s), it is possible that there will be a lapse of time between the completion of packing and the actual pick-up of materials from the booth for loading onto a carrier. It is understood that during such times the shipment(s) will be left in the booth unattended.

Therefore, it is agreed that GES and its subcontractors are not responsible for the loss or disappearance of Exhibitor's materials after the same have been delivered to Exhibitor's booth, nor are GES and its subcontractors responsible for Exhibitor's materials before they are picked up from the Exhibitor's booth for loading after the show. Consequently, all bills of lading covering outgoing shipment(s) submitted to GES or its subcontractors by Exhibitor will be checked at the time of pick-up from the booth and corrected where discrepancies exist.

3. GES and its subcontractors shall not be held liable for any damage incurred during the handling of equipment requiring special devices to properly load, place or reload unless advance notice has been given to GES in time to obtain the proper equipment.

4. GES and its subcontractors shall not be responsible for loss, delay or damage due to strikes, lockouts or work stoppages of any kind.

5. GES and its subcontractors shall not be responsible for ordinary wear and tear in handling of equipment, nor for loss or damage due to fire, theft, windstorm, water, vandalism, acts of God, mysterious disappearance or other causes beyond their control.

6. It is understood that GES and its subcontractors are not insurers. Insurance, if any, shall be obtained by the Exhibitor. Amounts payable to GES hereunder are based on the scope of the liability as herein set forth and are unrelated to the value of the Exhibitor's property. It is further understood and agreed that GES and its subcontractors do not provide for full liability should loss or damage occur. It is agreed that if GES or its subcontractors should be found liable for loss or damage to Exhibitor's equipment, the liability shall be limited to the specific article that was physically lost or damaged. Such liability shall be limited to a sum equal to \$0.30 per pound per article, with a maximum liability of \$50.00 per item or \$1,000.00 per shipment, whichever is less, as agreed upon damages and exclusive remedy. Provisions of this paragraph shall apply if loss or damage, regardless of cause or origin, results directly or indirectly to property through performance services to

Exhibitor's or from negligence, active or otherwise, by GES, its subcontractors or their employees.

7. GES and its subcontractors shall not be liable to any extent whatsoever for any actual, potential or assumed loss of profits or revenues or for any collateral costs that may result from any loss or damage to Exhibitor's materials which may make it impossible or impracticable to exhibit same.

8. Claims for loss or damage must be submitted to GES by the close of the show. No suit or action shall be brought against GES or its subcontractors more than one year after the cause of action.

9. The Exhibitor agrees, in connection with the receipt, handling, temporary storage and reloading of its materials, that GES and its subcontractors will provide these services as Exhibitor's agent and not as bailee or shipper. If any employee of GES or its subcontractors shall sign a delivery receipt, bill of lading or other document, we agree that GES or its subcontractor will do so as the Exhibitor's agent, and the Exhibitor accepts the responsibility thereof.

10. GES and its subcontractors shall not be liable for shipments received without receipts, freight bills or specified unit counts on receipts or freight bills, such as a courier or van lines. Such shipments will be delivered to booth without guarantee of piece count or condition.

11. Empty container labels will be available at the GES Service Centre. Affixing the labels is the sole responsibility of the Exhibitor or its representative. It is understood that these labels are used for EMPTY STORAGE ONLY, and GES and its subcontractors assume no responsibility for loss or damage to contents while containers are in storage or for mislabelled containers.

12. In order to expedite removal of materials from the show site, GES shall have the authority to change designated carriers, if such carriers do not pick up on time. Where no disposition is made by the Exhibitor, materials will be taken to a warehouse to await Exhibitor's shipping instructions, and the Exhibitor agrees to be responsible for payment of charges relating to such handling at the warehouse. GES assumes no liability as a result of such re-routing or handling.

13. The Exhibitor agrees, in the event of a dispute with GES or its subcontractors relative to any loss or damage to any of your materials or equipment, that the Exhibitor will not withhold payment in any amount due to GES for material handling services or any other services provided by GES or its subcontractors as an offset against the amount of the alleged loss or damage. Instead, the Exhibitor agrees to pay GES prior to the close of the show for all such charges and further agrees that any claim the Exhibitor may have against GES or its subcontractors shall be pursued independently by the Exhibitor as a completely separate transaction to be resolved on its own merits.

The consignment or delivery of a shipment to GES or its subcontractors by an Exhibitor or by any shipper on behalf of the Exhibitor shall be construed as an acceptance by such Exhibitor (and/or other shipper) of the terms and conditions set forth in Sections 1 through 13 above.

**Be sure your materials are insured** from the time they leave your firm until they are returned after the show. It is suggested that Exhibitors arrange all risk coverage. This can usually be done by riders to existing policies. Contact your insurance representative. Be sure your liability insurance is in effect during transit and return of your materials, during storage and at show site.