

GES is pleased to have been selected the official service contractor by the Show Organizer to design and produce your show. Our goal is to ensure your show participation is a success.

GES is involved in many areas relative to the show and if at any time during the planning process you are unsure where to turn, just ask us, we are at your service.

Please ensure that you review this section carefully as it contains information, **DISCOUNT PRICES** and order forms for each of the many services being provided by **GES**.

For your convenience, we will be offering the following services:

- ✓ **Expresso Online Ordering**
- ✓ **Furnishings**
- ✓ **Carpet & Underpadding**
- ✓ **Specialty Furnishings**
- ✓ **GEM Exhibits & Accessories**
- ✓ **Signs & Graphics**
- ✓ **Plants**
- ✓ **Installation & Dismantling Labour**
- ✓ **Material Handling**
- ✓ **GES Logistics / Shipping**
- ✓ **GES Customs**

To take advantage of our **DISCOUNT PRICING**, all order forms and full payment must be received on or before the Discount Date of **June 3, 2016** as indicated on each form. **GES** accepts Visa, MasterCard, American Express, Cheques and Cash as methods of payment for our services. All exhibitors are responsible for payment of H.S.T. when exhibiting in Ontario.

If you need assistance or additional information, please contact our **Exhibitor Services Department at (905) 283-0500**.



Show Information

AACE Annual Meeting - 2016
 Sheraton Centre Toronto Hotel
 June 26 - 28, 2016

Venue Shipping Address Advance Warehouse Shipping Address

Sheraton Centre Toronto Hotel Loading Dock 100 Richmond Street Toronto, Ontario, Canada M5H 3K6	GES/AACE Annual Meeting (Company Name & Booth #) 6130 Netherhart Rd. Mississauga, Ontario, Canada L5T 1B7
--	--

*** See shipping labels in the exhibitor manual. Note receiving dates below.**

Official Services Contractor

Global Experience Specialists, Inc. (GES) 5675 McLaughlin Road Mississauga, Ontario, Canada L5R 3K5	Phone 905-283-0500 Fax 905-283-0501 Web Site www.gesexpo.ca E-Mail torontoexhibitorservices@ges.com
--	--

Show Information

Booth Size Backwall Drape Sidewall Drape Aisle Carpet Colour Booth Packages Includes	10' X 10' 8 foot Blue Drape 3 foot Blue Drape Venue carpet - multicolored Draped Booth 1 - 6 foot Draped Table - white 2 Grey Fabric Side Chairs 1 Wastebasket 1 - ID Sign (7" X 44" - name only)
--	---

Important Dates - Prior to Show

Discount Deadline for GES orders received with payment Advance Shipments may begin arriving at the Warehouse Last day for Advance Shipments to arrive at the Warehouse Direct Shipments may arrive at Exhibit Site Last day for Direct Shipments to arrive at Exhibit Site	Friday, June 3 Friday, May 27 Friday, June 17 Saturday, June 25 Sunday, June 26	 <i>Hours of receiving Monday - Friday, 9:00 am - 4:00 pm</i> <i>Hours of receiving Monday - Friday, 9:00 am - 4:00 pm</i> 1 PM - 6 PM 9 AM - 1 PM
--	---	--

Important Dates - At the Show

Move In Show Hours Move Out	Saturday, June 25 Sunday, June 26 Sunday, June 26 Monday, June 27 Tuesday, June 28 Tuesday, June 28	1 PM - 6 PM 9 AM - 1 PM 3:45 PM - 8 PM 7 AM - 3:30 PM 7 AM - 3:30 PM 3:30 PM - 6 PM
---	--	--

GES On-Site Service Centre

GES will operate a GES Service Desk to help take care of your on-site requirements such as Furniture and Material Handling.

The Service Desk will be open during the following times:

Exhibitor Services	Saturday, June 25	1 PM - 6 PM
Exhibitor Services	Sunday, June 26	9 AM - 4 PM
Customs & Logistics	Tuesday, June 28	1 PM - 6 PM



Accelerate your experience with Expresso exhibit planning, ordering and management.

Exhibitors can order everything they need for their tradeshow exhibit through Expresso, our simple to navigate, picture-driven system that satisfies your need for speed. With just a few clicks exhibitors can order GES products and services including:

- Booth furniture.
- Carpet and flooring.
- Material handling.
- Booth labour.
- And much more.

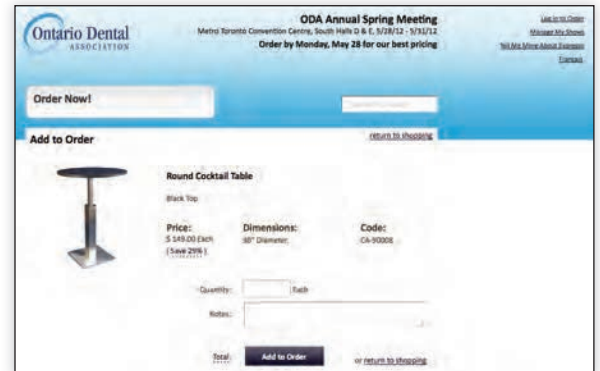

Expresso is more than just an online exhibitor manual. Exhibitors can:

- Order exhibit products and services.
- Print shipping labels.
- View important show and event information.
- Download the show schedule into Outlook or iCalendar.
- View account order status and history.

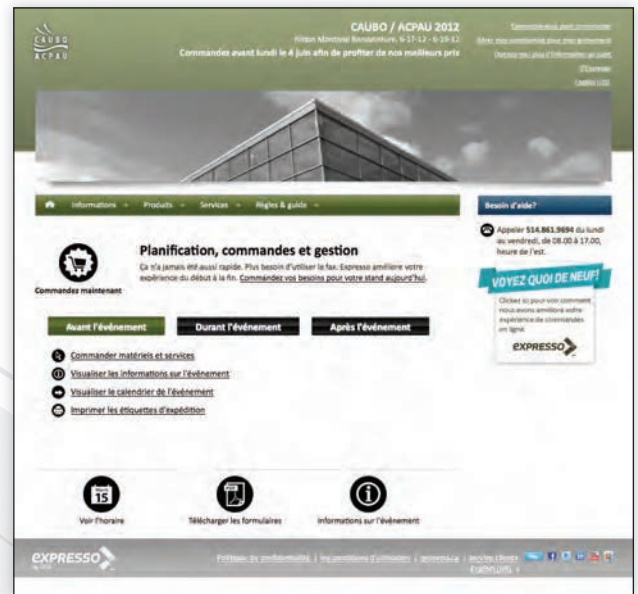

Experience a difference with Expresso.

- Each show has their own custom website.
- Runs on all browsers for PCs, Macs and tablets.
- Everything in one place; all organizer and show information, ordering and even third party forms.
- Keeps you on-time and on-budget.





5675 McLaughlin Road, Mississauga, Ontario, L5R 3K5 Tel: 905-283-0500 Fax: 905-283-0501 Toll Free: 1-877-437-4247 www.gesexpo.ca
torontoexhibitorservices@ges.com www.gesexpo.ca

PAYMENT POLICY INFORMATION SHEET

DISCOUNT PRICING:

To qualify for **Discount Pricing**, orders must be received **with payment in full on or before the deadline date.** After the Deadline Date, orders will be charged the **Regular Prices**. Orders without payment cannot be processed until payment is received and could be charged the **Regular Price**.

METHOD OF PAYMENT:

GES accepts American Express, MasterCard, Visa, Debit Card, Cheques, Bank Wire and Electronic Funds Transfers (EFT).

Exhibitors will be charged a \$25.00 fee for returned NSF cheques.

BANK WIRE AND ELECTRONIC FUNDS TRANSFER INFORMATION:

To properly credit your account, please complete the **BANK WIRE / EFT FORM** included with the GES order forms.

NOTE: There is a minimum \$20.00 Service Charge (North America) \$40.00 (International) applicable on all Wire and EFTs. Any additional Wire Transfer and EFT fees are the exhibitors responsibility and may vary depending on the processing bank.

Please ensure the transfer is made a minimum of 10 days prior to the show.

PAYMENT SCHEDULE:

Payment for all services must be pre-paid in full. GES will not provide Material Handling, In-Booth Forklifts, or Installation and Dismantle Labour Services without your company's **CREDIT CARD AUTHORIZATION FORM** on file.

THIRD PARTY BILLING:

You may arrange for an exhibit house or Third Party to manage your exhibit and order services on your behalf. GES will agree to this arrangement if the exhibit house or agent makes satisfactory payment arrangements with us. In the event the authorized Third Party does not pay, each exhibiting company is ultimately responsible for all charges incurred on its behalf. See **THIRD PARTY BILLING REQUEST FORM**.

ADJUSTMENTS AND CANCELLATIONS:

Adjustments to your invoice **will not be made after the close of the show.** Some items, services and labour are subject to cancellation fees. Refer to each order form for details.

ALL EXHIBITORS MUST PAY 13% HST ON ALL ORDERS.



5675 McLaughlin Road, Mississauga, Ontario, L5R 3K5 Tel: 905-283-0500 Fax: 905-283-0501 Toll Free: 1-877-437-4247
torontoexhibitorservices@ges.com www.gesexpo.ca

CREDIT CARD AUTHORIZATION

SHOW: **AACE Annual Meeting 2016**

EXHIBITOR INFORMATION

BOOTH #: _____

COMPANY _____

STREET _____

CITY _____ PROV/STATE _____ CODE _____

E-MAIL _____

PHONE _____ FAX _____

CONTACT NAME _____

IMPORTANT - READ CAREFULLY

Please fill out The Credit Card Authorization below if:

- You or your company are forwarding payment to GES in the form of a cheque.
- There is any possibility you or your representative will be ordering any service on-site.
- You are ordering Material Handling, Installation and Dismantle Labour or In-Booth Forklift Services.

PLEASE COMPLETE THE FOLLOWING

MASTERCARD VISA AMERICAN EXPRESS

CORPORATE PERSONAL

EXPIRY DATE:

CARD #

CARDHOLDER'S NAME (PRINT): _____

CARDHOLDER'S SIGNATURE: _____

Cardholder's Billing Address: _____

City: _____ Prov/State: _____ Code/Zip: _____

Tel: _____ Fax: _____

This authorization allows GES to charge any fees outstanding after show closing to this credit card (including funds owed due to a cheque returned NSF)

CHEQUES WILL NOT BE ACCEPTED WITHOUT THIS CREDIT CARD AUTHORIZATION

IF THIS AUTHORIZATION IS NOT COMPLETED, ALL ON-SITE ORDERS ARE EXPECTED TO BE PAID IN FULL BEFORE DELIVERY



5675 McLaughlin Road, Mississauga, Ontario, L5R 3K5 Tel: 905-283-0500 Fax: 905-283-0501 Toll Free: 1-877-437-4247
torontoexhibitorservices@ges.com www.gesexpo.ca

THIRD PARTY BILLING FORM

SHOW: **AACE Annual Meeting 2016**

EXHIBITOR INFORMATION

BOOTH #: _____
COMPANY _____
STREET _____
CITY _____ PROV/STATE _____ CODE _____
E-MAIL _____
PHONE _____ FAX _____
CONTACT NAME _____

You may arrange for an exhibit house or other agent to handle your display & be charged for services. GES will agree to this arrangement if the exhibit house or agent makes satisfactory payment arrangements with us. Both firms must complete this form and return to GES by the Discount Price Deadline Date. It is understood and agreed that the exhibitor is ultimately responsible for payment of charges. If your named third party has not paid the invoice before the last day of the show, any outstanding balance will be charged to the exhibitor's credit card.

Exhibiting Company

Name of Exhibiting Company Phone # Fax #

Address City Prov/State Code/Zip

Authorized Name (print) Authorized Signature

CREDIT CARD AUTHORIZATION

MASTERCARD VISA AMERICAN EXPRESS EXPIRY DATE: _____
 CORPORATE PERSONAL
CARD # _____

Cardholder's Name (print) Cardholder's Signature

Third Party / Exhibit House

Name of Third Party/Exhibit House Phone # Fax #

Address City Prov/State Code/Zip

Authorized Name (print) Authorized Signature

CREDIT CARD AUTHORIZATION

MASTERCARD VISA AMERICAN EXPRESS EXPIRY DATE: _____
 CORPORATE PERSONAL
CARD # _____

Cardholder's Name (print) Cardholder's Signature

ALL GES SERVICES ARE TO BE CHARGED TO THE THIRD PARTY EXCEPT FOR THE FOLLOWING:



**ELECTRONIC FUNDS/WIRE
TRANSFER FORM**

5675 McLaughlin Road, Mississauga, Ontario, L5R 3K5 Phone: 905-283-0500 Fax: 905-283-0501

**Please complete and return this form to : Jolanta Baloniak, Accounts Receivable
GES Exposition Services (Canada) Limited
Email: ar@ges.com Fax: 905-283-0501**

Your Company Name: _____
Contact Name: _____
Contact Number: _____
Booth Number: _____ **Event Name:** AACE Annual Meeting 2016

GES BANK INFORMATION

PLEASE INCLUDE ALL OF THE FOLLOWING INFORMATION TO ENSURE YOUR FUNDS REACH OUR BANK

Account Name: GES Exposition Services (Canada) Limited
Bank Name: Bank of Montreal
Address: 350-7th Avenue SW
Calgary, AB
T2P 3N9

*IF YOU ARE SENDING CANADIAN DOLLARS

*IF YOU ARE SENDING AMERICAN DOLLARS

EFT/Direct Deposit

Institution code #: 001
Transit #: 00109
Account #: 1967-990

Institution code #: 001
Transit #: 00109
Account #: 4773-410

Wire Transfers

Account #: 1967-990
Beneficiary's Bank: //CC000100109
Swift Code: BOFMCAM2

Account #: 4773-410
Beneficiary's Bank: //CC000100109
Intermediary Bank: Wells Fargo Bank (FKA Wachovia)
Swift Code: PNBPUS3NNYC

Routing / BIC / NCC / BSC or ABA Number: 026005092

Invoice Amount: _____

Date of Transfer: _____

***Minimum Bank Charge:** \$20.00 (North American) \$40.00 (International)

Total: _____

Please Note: Ensure transfer is made a minimum of 10 days prior to the show move in date.
*Minimum Bank Charges as shown above, reflect GES's bank charges only.
Any additional wire transfer and EFT fees are the exhibitor's responsibility.



GES *Global
Experience
Specialists*

furnishings



Grey Fabric Side Chair



Grey Fabric
Counter Stool



Grey Fabric Arm Chair



Grey Lounge Chair



Steno Chair



30" Round / 30" High
Starbase Table



30" Round / 18" High
Coffee Table



4' and 6' Long
Skirted Counter
with White Vinyl Top



4', 6', or 8' Long
Skirted Table
with White Vinyl Top



furnishings



Coat Tree



22" W X 28" H
Chrome Sign Holder
(sign extra)



Easel



Gold Ballot Drum

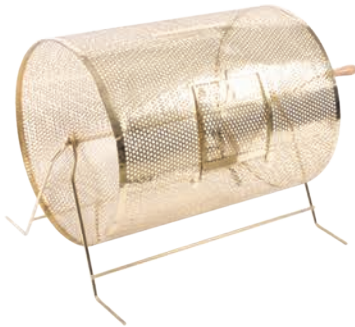

Plexi Pocket
(Wall Mountable only,
not self-standing)



40" W x 20" D x 41" H
White Counter Storage Unit



Bag Holder 41"H



Stanchions
6' Belt



Plastic
Wastebasket



5675 McLaughlin Road, Mississauga, Ontario, L5R 3K5 Tel: 905-283-0500 Fax: 905-283-0501 Toll Free: 1-877-437-4247
torontoexhibitorservices@ges.com www.gesexpo.ca

SHOW: **AACE Annual Meeting 2016**

EXHIBITOR INFORMATION

BOOTH #: _____

COMPANY _____

STREET _____

CITY _____ PROV/STATE _____ CODE _____

E-MAIL _____

PHONE _____ FAX _____

CONTACT NAME _____

DISCOUNT PRICE DEADLINE DATE: **June 3, 2016**

CREDIT CARD AUTHORIZATION

MASTERCARD VISA AMEX

_____|_____|_____|_____|_____|_____|_____|_____|_____|_____|

EXPIRY DATE _____ / _____

CARDHOLDER NAME _____

CARDHOLDER SIGNATURE _____

CHEQUE ATTACHED (PAYABLE TO GES CANADA)

ALL ORDERS MUST BE PREPAID IN FULL (ORDERS CAN NOT BE PROCESSED UNTIL PAYMENT IS RECEIVED)

FURNISHINGS				
QTY	DESCRIPTION	DISCOUNT PRICE	REGULAR PRICE	TOTAL
	Grey Fabric Side Chair	\$45.00	\$68.00	
	Grey Fabric Counter Stool	\$92.00	\$137.00	
	Grey Fabric Arm Chair	\$65.00	\$98.00	
	Grey Lounge Chair	\$86.00	\$129.00	
	Steno Chair	\$89.00	\$133.00	
	Starbase Table 30" Round 30" High	\$93.00	\$139.00	
	30" Round 18" High Coffee Table	\$71.00	\$106.00	
	Coat Tree	\$39.00	\$60.00	
	22" x 28" Chrome Sign Holder (Sign Extra)	\$82.00	\$122.00	
	Easel	\$50.00	\$75.00	
	Gold Ballot Drum	\$96.00	\$143.00	
	Plexi Pocket (wall mountable only)	\$37.00	\$56.00	
	White Counter Storage Unit 41" H	\$233.00	\$349.00	
	Bag Holder 41"H	\$74.00	\$111.00	
	1 Pair of Stanchions	\$140.00	\$210.00	
	Plastic Wastebasket	\$17.00	\$26.00	

SKIRTED TABLES 30" HIGH				
<input type="checkbox"/> BLACK <input type="checkbox"/> BLUE <input type="checkbox"/> BURGUNDY <input type="checkbox"/> GREEN <input type="checkbox"/> RED <input type="checkbox"/> SILVER <input type="checkbox"/> WHITE				
QTY	DESCRIPTION	DISCOUNT PRICE	REGULAR PRICE	TOTAL
	4 Ft. Long x 2 Ft. Wide	\$87.00	\$131.00	
	6 Ft. Long x 2 Ft. Wide	\$103.00	\$155.00	
	8 Ft. Long x 2 Ft. Wide	\$131.00	\$196.00	
	Skirted Fourth Side	Add \$59.00 ea.		

SKIRTED COUNTER 42" HIGH				
<input type="checkbox"/> BLACK <input type="checkbox"/> BLUE <input type="checkbox"/> SILVER <input type="checkbox"/> WHITE				
QTY	DESCRIPTION	DISCOUNT PRICE	REGULAR PRICE	TOTAL
	4 Ft. Long x 2 Ft. Wide	\$131.00	\$196.00	
	6 Ft. Long x 2 Ft. Wide	\$148.00	\$222.00	
	Skirted Fourth Side	Add \$59.00 ea.		

NON SKIRTED TABLES				
	<input type="checkbox"/> 4 Ft. <input type="checkbox"/> 6 Ft. <input type="checkbox"/> 8 Ft.	\$64.00	\$96.00	
	42" H <input type="checkbox"/> 4 Ft. <input type="checkbox"/> 6 Ft.	Add \$60.00 ea.		

CUSTOM BOOTH DRAPING				
<input type="checkbox"/> BLACK <input type="checkbox"/> BLUE <input type="checkbox"/> RED <input type="checkbox"/> SILVER <input type="checkbox"/> WHITE				
	DESCRIPTION	DISCOUNT PRICE	REGULAR PRICE	TOTAL
	3 Ft. High (Per Linear Ft.)	\$12.00	\$18.00	
	8 Ft. High (Per Linear Ft.)	\$16.00	\$25.00	

Terms & Conditions

- All orders received after the Discount Price Date will be processed at the Regular Price.
- Exhibitor is responsible for all items for the duration of the show.
- If a colour is not chosen, GES will choose a colour for you.
- Charges are for rental of equipment only. All items remain the property of GES.
- GES is not responsible for exhibit materials left in GEM rental exhibits or counter storage units.
- All claims or discrepancies must be settled at the GES Service Centre prior to show closing.
- No refunds/exchanges on cancelled skirted tables or custom booth draping once delivered.
- 50% refund on furnishings cancelled prior to show opening.

SUBTOTAL	
13% HST	
TOTAL	
HST #R104060264	

I have read and understand the Terms & Conditions of my Agreement with GES.

Signature

Date

5675 McLaughlin Road, Mississauga, Ontario, L5R 3K5 Tel: 905-283-0500 Fax: 905-283-0501 Toll Free: 1-877-437-4247
torontoexhibitorservices@ges.com www.gesexpo.ca

SHOW: AACE Annual Meeting 2016	DISCOUNT PRICE DEADLINE DATE: June 3, 2016												
EXHIBITOR INFORMATION	CREDIT CARD AUTHORIZATION												
BOOTH #: _____	<input type="checkbox"/> MASTERCARD <input type="checkbox"/> VISA <input type="checkbox"/> AMEX												
COMPANY _____	<table border="1" style="width: 100%; border-collapse: collapse; text-align: center;"> <tr> <td style="width: 25px;"> </td><td style="width: 25px;"> </td><td style="width: 25px;"> </td><td style="width: 25px;"> </td> <td style="width: 25px;"> </td><td style="width: 25px;"> </td><td style="width: 25px;"> </td><td style="width: 25px;"> </td> <td style="width: 25px;"> </td><td style="width: 25px;"> </td><td style="width: 25px;"> </td><td style="width: 25px;"> </td> </tr> </table>												
STREET _____	EXPIRY DATE ____ / ____												
CITY _____ PROV/STATE _____ CODE _____	CARDHOLDER NAME _____												
E-MAIL _____	CARDHOLDER SIGNATURE _____												
PHONE _____ FAX _____	<input type="checkbox"/> CHEQUE ATTACHED (PAYABLE TO GES CANADA)												
CONTACT NAME _____													

ALL ORDERS MUST BE PREPAID IN FULL (ORDERS CAN NOT BE PROCESSED UNTIL PAYMENT IS RECEIVED)

Please note: The exhibit hall is carpeted. Additional booth carpet is optional.

BOOTH CARPET - STANDARD SIZE					
Note: Exhibitors ordering multiple pieces of carpet in this section may not receive the same dyelot.					
QTY	Item #	DESCRIPTION	DISCOUNT PRICE	REGULAR PRICE	TOTAL
	C1010	10 Ft. X 10 Ft. Single Booth	\$213.00	\$320.00	
	C1020	10 Ft. X 20 Ft. Double Booth	\$363.00	\$544.00	
COLOUR SELECTION: <input type="checkbox"/> BLACK <input type="checkbox"/> BLUE <input type="checkbox"/> GREY <input type="checkbox"/> RED					

Item #	BOOTH CARPET - CUSTOM SIZE (INCLUDING PLASTIC)				
If your booth requires a size not listed above, please complete this section.					
CUSTC	BOOTH SIZE: ____ Ft. x ____ Ft. = ____ Sq. Ft.	\$2.68/Sq. Ft.	\$4.04/Sq. Ft.		
COLOUR SELECTION: <input type="checkbox"/> BLACK <input type="checkbox"/> BLUE <input type="checkbox"/> GREY <input type="checkbox"/> RED					
Item #	UNDERPADDING PRICE PER SQUARE FOOT INSTALLED (100 SQ. FT. MIN.)				
CACU	BOOTH SIZE: ____ Ft. x ____ Ft. = ____ Sq. Ft.	\$1.28/Sq. Ft.	\$1.90/Sq. Ft.		
Item #	PROTECTIVE PLASTIC COVERING PRICE PER SQUARE FOOT INSTALLED (STANDARD SIZES ONLY)				
CAPC	BOOTH SIZE: ____ Ft. x ____ Ft. = ____ Sq. Ft.	\$0.56/Sq. Ft.	\$0.83/Sq. Ft.		

PLEASE SELECT ONE FOR CUSTOM CARPET SIZES ONLY
IF ORDERING ELECTRICAL OR TELECOMMUNICATIONS SERVICES, WILL UNDER CARPET WIRING BE REQUIRED? <input type="checkbox"/> YES <input type="checkbox"/> NO

Terms & Conditions

- All orders received after the Discount Price Date will be processed at the Regular Price.
- Exhibitor is responsible for all items for the duration of the show.
- No refunds/exchanges on carpets once delivered.
- Charges are for rental of equipment only. All items remain the property of GES.
- All claims or discrepancies must be settled at the GES Service Centre prior to show closing.
- If a colour is not chosen, GES will choose a colour for you. *Carpet colour subject to availability.*

SUBTOTAL	
13% HST	
TOTAL	
	HST #R104060264

I have read and understand the Terms & Conditions of my Agreement with GES.

Signature

Date

specialty furniture



Black Ladder Stool



Equino White Stool



White Leather Stool

Red Leather Stool



Black Leather Stool

Chrome Wireback Stool



White Sculpted Leather Chair



Also available in black or red

White Sculpted Leather Loveseat

24" Square Chrome/White Cocktail Table



30" Round Cocktail Table Black Top

30" Square Cocktail Table Black Top



Throw Pillows



Available in:



Q Still can't find it?

For more options please contact the Exhibitor Services Department **905.283.0500**

torontoexhibitorservices@ges.com

specialty furniture



42" Round Black Meeting Table



Grey Leather Ripple Sled Base Meeting Chair



Black Leather Ripple Sled Base Meeting Chair



Bar Fridge



Literature Stand



White Meeting Chair



Round Meeting Chairs



48" Black Coffee Table



72" Chrome & White Meeting Table



48" White Coffee Table



24" Round End Table White Top



24" Round End Table Black Top



Also available in 39" round coffee tables

32" Round Coffee Table Black Top



32" Round Coffee Table White Top



Black Round Tub Chairs



White Round Tub Chairs



Still can't find it?

For more options please contact the Exhibitor Services Department **905.283.0500**

torontoexhibitorservices@ges.com

5675 McLaughlin Road, Mississauga, Ontario, L5R 3K5 Tel: 905-283-0500 Fax: 905-283-0501 Toll Free: 1-877-437-4247
torontoexhibitorservices@ges.com www.gesexpo.ca

SHOW: AACE Annual Meeting 2016	DISCOUNT PRICE DEADLINE DATE: June 3, 2016										
EXHIBITOR INFORMATION											
BOOTH #: _____											
COMPANY _____											
STREET _____											
CITY _____ PROV/STATE _____ CODE _____											
E-MAIL _____											
PHONE _____ FAX _____											
CONTACT NAME _____											
CREDIT CARD AUTHORIZATION											
<input type="checkbox"/> MASTERCARD <input type="checkbox"/> VISA <input type="checkbox"/> AMEX <table style="width:100%; border: none;"> <tr> <td style="border: 1px solid black; width: 25px; height: 20px;"></td> <td style="border: 1px solid black; width: 25px; height: 20px;"></td> <td style="border: 1px solid black; width: 25px; height: 20px;"></td> <td style="border: 1px solid black; width: 25px; height: 20px;"></td> <td style="border: 1px solid black; width: 25px; height: 20px;"></td> <td style="border: 1px solid black; width: 25px; height: 20px;"></td> <td style="border: 1px solid black; width: 25px; height: 20px;"></td> <td style="border: 1px solid black; width: 25px; height: 20px;"></td> <td style="border: 1px solid black; width: 25px; height: 20px;"></td> <td style="border: 1px solid black; width: 25px; height: 20px;"></td> </tr> </table>											
EXPIRY DATE _____ / _____											
CARDHOLDER NAME _____											
CARDHOLDER SIGNATURE _____											
<input type="checkbox"/> CHEQUE ATTACHED (PAYABLE TO GES CANADA)											

ALL ORDERS MUST BE PREPAID IN FULL (ORDERS CAN NOT BE PROCESSED UNTIL PAYMENT IS RECEIVED)

QTY	DESCRIPTION	DISCOUNT PRICE	REGULAR PRICE	TOTAL
	Black Ladder Stool (Cloth Seat)	\$148.00	\$222.00	
	Equino White Stool	\$177.00	\$267.00	
	Leather Stool <input type="checkbox"/> white <input type="checkbox"/> red <input type="checkbox"/> black	\$177.00	\$267.00	
	Chrome Wireback Stool	\$181.00	\$277.00	
	Sculpted Leather Chair <input type="checkbox"/> white <input type="checkbox"/> red <input type="checkbox"/> black	\$255.00	\$384.00	
	Sculpted Leather Loveseat <input type="checkbox"/> white <input type="checkbox"/> red <input type="checkbox"/> black	\$348.00	\$522.00	
	Chrome/White Cocktail Table (24" square top, 42" high)	\$167.00	\$250.00	
	Round Cocktail Table (Black 30" diameter top, 42" high)	\$182.00	\$274.00	
	Square Cocktail Table (Black 30" top, 42" high)	\$182.00	\$274.00	
	Corbusier Leather Chair <input type="checkbox"/> white <input type="checkbox"/> red <input type="checkbox"/> black	\$299.00	\$449.00	
	Corbusier Leather Loveseat <input type="checkbox"/> white <input type="checkbox"/> red <input type="checkbox"/> black	\$391.00	\$588.00	
	18" Throw Pillows <input type="checkbox"/> white <input type="checkbox"/> pink <input type="checkbox"/> blue <input type="checkbox"/> red <input type="checkbox"/> orange <input type="checkbox"/> yellow <input type="checkbox"/> black <input type="checkbox"/> green	\$28.00	\$41.00	

QTY	DESCRIPTION	DISCOUNT PRICE	REGULAR PRICE	TOTAL
	42" Black Meeting Table (Round)	\$161.00	\$241.00	
	Leather Ripple Sled Base Meeting Chair <input type="checkbox"/> grey <input type="checkbox"/> black	\$132.00	\$198.00	
	Bar Fridge	\$220.00	\$331.00	
	Literature Stand	\$195.00	\$240.00	
	White Meeting Chair	\$129.00	\$193.00	
	72" Chrome & White Meeting Table	\$238.00	\$388.00	
	Round Meeting Chairs <input type="checkbox"/> white <input type="checkbox"/> red <input type="checkbox"/> black	\$116.00	\$175.00	
	24"x48" Coffee Table <input type="checkbox"/> white top <input type="checkbox"/> black top	\$174.00	\$263.00	
	24" Round End Table <input type="checkbox"/> white top <input type="checkbox"/> black top	\$139.00	\$209.00	
	Round Coffee Table <input type="checkbox"/> 32" <input type="checkbox"/> 39" <input type="checkbox"/> white top <input type="checkbox"/> black top	\$157.00	\$236.00	
	Round Tub Chairs <input type="checkbox"/> white <input type="checkbox"/> black	\$250.00	\$376.00	
NOTE* 3 Seater Sofa Available Upon Request. On-site orders are subject to availability.				

Terms & Conditions

- Colours, sizes and styles may vary.
- All orders received after the Discount Price Date will be processed at the Regular Price.
- Exhibitor is responsible for all items for the duration of the show.
- There will be no refunds/exchanges for cancellations on-site.
- Charges are for rental of equipment only. All items remain the property of GES.
- All claims or discrepancies must be settled at the GES Service Centre prior to show closing.

SUBTOTAL	
13% HST	
TOTAL	
HST #R104060264	

I have read and understand the Terms & Conditions of my Agreement with GES.

Signature

Date

5675 McLaughlin Road, Mississauga, Ontario, L5R 3K5 Tel: 905-283-0500 Fax: 905-283-0501 Toll Free: 1-877-437-4247 www.gesexpo.ca
torontoexhibitorservices@ges.com www.gesexpo.ca

SHOW: **AACE Annual Meeting 2016**

EXHIBITOR INFORMATION

BOOTH #: _____

COMPANY _____

STREET _____

CITY _____ PROV/STATE _____ CODE _____

E-MAIL _____

PHONE _____ FAX _____

CONTACT NAME _____

DISCOUNT PRICE DEADLINE DATE: **June 3, 2016**

CREDIT CARD AUTHORIZATION

MASTERCARD VISA AMEX

_____|_____|_____|_____|_____|_____|_____|_____|

EXPIRY DATE ____/____/____

CARDHOLDER NAME _____

CARDHOLDER SIGNATURE _____

CHEQUE ATTACHED (PAYABLE TO GES CANADA)

GEM SHOW SPECIAL INCLUDES:
• Header Sign(s) - 12"x78" • Infill Panels • Carpet • Installed & Dismantled • No Labour Costs • No Material Handling Costs

PACKAGE A: 10'x10' BOOTH



PACKAGE B: 10'x20' BOOTH



(No substitutions please. If you require additional furniture, please refer to the GES order forms enclosed in the manual).

QTY	Item #	Description	Discount Price	Regular Price	Total Price
	SS001	Package A - 10' x 10'	\$899.00	\$1,349.00	
	SS002	Package B - 10' x 20'	\$1,349.00	\$2,024.00	

PLEASE SELECT YOUR CHOICE OF INFILL PANEL AND CARPET COLOUR:

Infill Panel Colour: Black Grey White *(All panel & carpet colours subject to availability.)*

Carpet Colour: Black Grey

Package A Identification Sign to Read: _____

Package B Identification Sign to Read: Left: _____ Right: _____

Custom Header to be added Custom Header Signs/Logos will be charged \$100.00 extra per sign

Please upload files to: <https://file.ges.com/>

ALL ORDERS MUST BE PREPAID IN FULL (ORDERS CAN NOT BE PROCESSED UNTIL PAYMENT IS RECEIVED)

Terms & Conditions

- Does not include lighting or electrical service.
- No refunds/exchanges once show move-in begins.
- All claims or discrepancies must be settled prior to show closing.
- All orders received after the Discount Price Date will be processed at the Regular Price.
- GES is not responsible for exhibit materials left in GEM rental exhibits or counter storage units.
- Changes to the structure design or graphics will result in additional fees.

SUBTOTAL	
13% HST	
TOTAL	
	HST #R104060264

I have read and understand the Terms & Conditions of my Agreement with GES.

Signature

Date



standard exhibit rentals

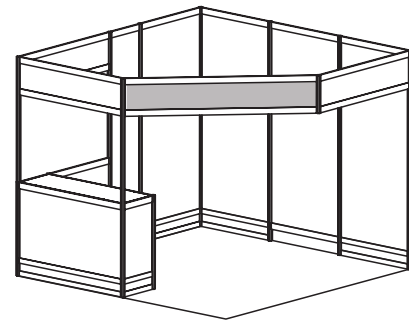

● GEM Model #1 - 10'x10' Corner

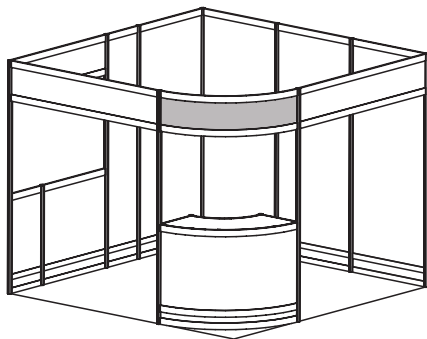

● GEM Model #2 - 10'x10' Corner

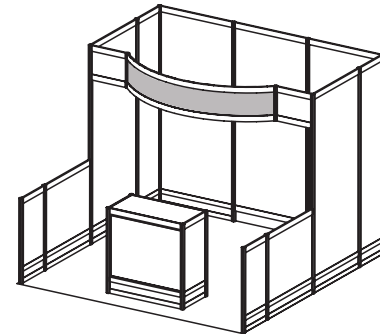

● GEM Model #3 - 10'x10'

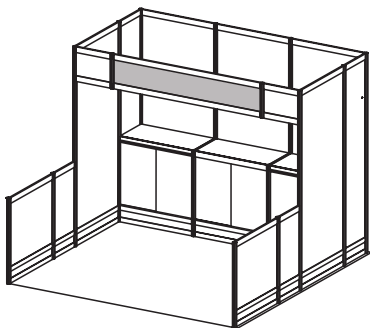

● GEM Model #4 - 10'x10'

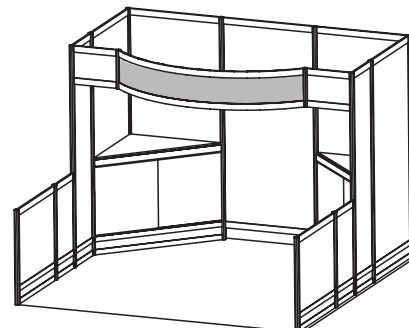

● GEM Model #5 - 10'x10'

3 Easy Steps →

- 1 Select the model number that suits your needs
- 2 Choose carpet and panel colours on the GEM Exhibit Rental order form
- 3 Complete & send order form

Grey indicates standard header sign(s)



standard exhibit rentals

10' X 20'
EXHIBITS

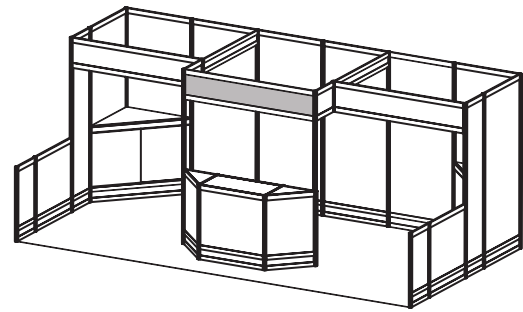

● GEM Model #6 - 10'x20'

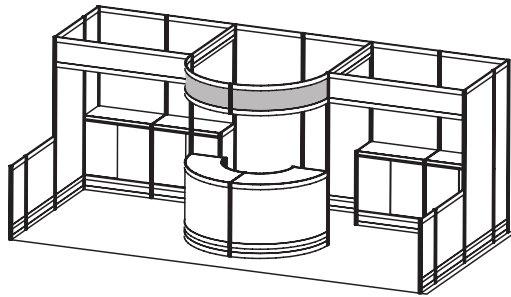

● GEM Model #7 - 10'x20'

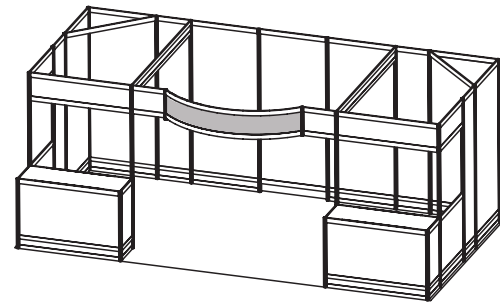

● GEM Model #8 - 10'x20'

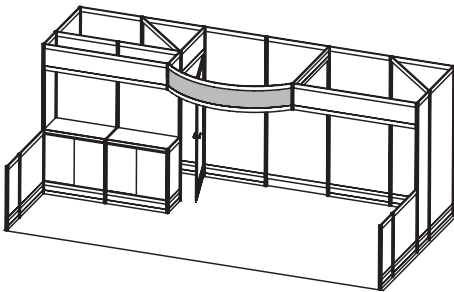

● GEM Model #9 - 10'x20'

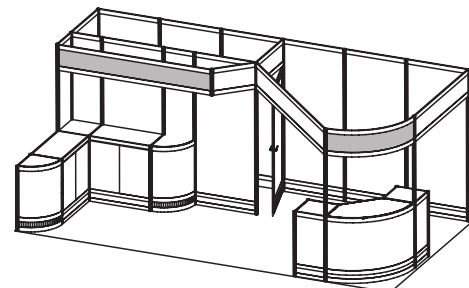

● GEM Model #10 - 10'x20' Corner

3 Easy Steps

- 1 Select the model number that suits your needs
- 2 Choose carpet and panel colours on the GEM Exhibit Rental order form
- 3 Complete & send order form

Grey indicates standard header sign(s)

5675 McLaughlin Road, Mississauga, Ontario, L5R 3K5 Tel: 905-283-0500 Fax: 905-283-0501 Toll Free: 1-877-437-4247
torontoexhibitorservices@ges.com www.gesexpo.ca

SHOW: AACE Annual Meeting 2016	DISCOUNT PRICE DEADLINE DATE: June 3, 2016										
EXHIBITOR INFORMATION											
BOOTH #: _____											
COMPANY _____											
STREET _____											
CITY _____ PROV/STATE _____ CODE _____											
E-MAIL _____											
PHONE _____ FAX _____											
CONTACT NAME _____											
CREDIT CARD AUTHORIZATION											
<input type="checkbox"/> MASTERCARD <input type="checkbox"/> VISA <input type="checkbox"/> AMEX <table style="width: 100%; border-collapse: collapse;"> <tr> <td style="border: 1px solid black; width: 25px; height: 20px;"></td> <td style="border: 1px solid black; width: 25px; height: 20px;"></td> <td style="border: 1px solid black; width: 25px; height: 20px;"></td> <td style="border: 1px solid black; width: 25px; height: 20px;"></td> <td style="border: 1px solid black; width: 25px; height: 20px;"></td> <td style="border: 1px solid black; width: 25px; height: 20px;"></td> <td style="border: 1px solid black; width: 25px; height: 20px;"></td> <td style="border: 1px solid black; width: 25px; height: 20px;"></td> <td style="border: 1px solid black; width: 25px; height: 20px;"></td> <td style="border: 1px solid black; width: 25px; height: 20px;"></td> </tr> </table>											
EXPIRY DATE _____ / _____											
CARDHOLDER NAME _____											
CARDHOLDER SIGNATURE _____											
<input type="checkbox"/> CHEQUE ATTACHED (PAYABLE TO GES CANADA)											

ALL ORDERS MUST BE PREPAID IN FULL (ORDERS CAN NOT BE PROCESSED UNTIL PAYMENT IS RECEIVED)

Item #	Discount Price	Regular Price	Item #	Discount Price	Regular Price
GEM001	\$1,864.00	\$2,796.00	GEM006	\$3,942.00	\$5,913.00
GEM002	\$1,652.00	\$2,478.00	GEM007	\$4,079.00	\$6,119.00
GEM003	\$1,968.00	\$2,951.00	GEM008	\$3,801.00	\$5,702.00
GEM004	\$2,361.00	\$3,540.00	GEM009	\$3,998.00	\$5,999.00
GEM005	\$2,190.00	\$3,284.00	GEM010	\$4,490.00	\$6,736.00

Package Includes: Installation & Dismantling, Choice of Carpet Colour, Choice of Panel Colour, Company Identification Sign
Package Does Not Include: Cleaning, Light Fixtures or Electrical Outlets

PLEASE SELECT YOUR CHOICE OF INFILL PANEL AND CARPET COLOUR	<i>Upgrade options available. Contact Exhibitor Services.</i>
ITEM #: <input style="width: 100px;" type="text"/>	
Infill Panel Colour: <input type="checkbox"/> Black <input type="checkbox"/> Grey <input type="checkbox"/> White	<i>Other panel colours available upon request. Contact Exhibitor Services.</i>
Carpet Colour: <input type="checkbox"/> Black <input type="checkbox"/> Blue <input type="checkbox"/> Grey <input type="checkbox"/> Red	<i>(All panel & carpet colours subject to availability.)</i>
Models 1, 2, 3, 4, 5, 6, 8 or 9 Identification Sign to Read: _____	
Models 7 or 10 Identification Sign to Read: Left: _____ Right: _____	
Indicate Date & Time for Arrival: _____	
Custom Header to be added <input type="checkbox"/> Custom Header Signs/Logos will be charged \$100.00 extra per sign	
Please upload files to: https://file.ges.com/	
ALL ORDERS MUST BE PREPAID IN FULL (ORDERS CAN NOT BE PROCESSED UNTIL PAYMENT IS RECEIVED)	

Terms & Conditions

- Payment may be made by cheque up to two weeks prior to the 1st day of move in.
- All orders received after the Discount Price Date will be processed at the Regular Price.
- Exhibitor is responsible for all items for the duration of the show.
- Charges are for rental of equipment only. All items remain the property of GES.
- No refunds/exchanges once show move-in begins. All claims or discrepancies must be settled prior to show closing.
- GES is not responsible for exhibit materials left in GEM rental exhibits or counter storage units.
- Changes to the structure design or graphics will result in additional fees.

SUBTOTAL	
13% HST	
TOTAL	
	HST #R104060264

I have read and understand the Terms & Conditions of my Agreement with GES.

Signature

Date

GEM EXHIBIT ACCESSORIES ORDER FORM

5675 McLaughlin Road, Mississauga, Ontario, L5R 3K5 Tel: 905-283-0500 Fax: 905-283-0501 Toll Free: 1-877-437-4247
torontoexhibitorservices@ges.com www.gesexpo.ca

SHOW: **AACE Annual Meeting 2016**

EXHIBITOR INFORMATION

BOOTH #: _____

COMPANY _____

STREET _____

CITY _____ PROV/STATE _____ CODE _____

E-MAIL _____

PHONE _____ FAX _____

CONTACT NAME _____

DISCOUNT PRICE DEADLINE DATE: **June 3, 2016**

CREDIT CARD AUTHORIZATION

MASTERCARD VISA AMEX

--	--	--	--	--	--	--	--	--	--

EXPIRY DATE ____ / ____

CARDHOLDER NAME _____

CARDHOLDER SIGNATURE _____

CHEQUE ATTACHED (PAYABLE TO GES CANADA)

ALL ORDERS MUST BE PREPAID IN FULL (ORDERS CAN NOT BE PROCESSED UNTIL PAYMENT IS RECEIVED)

QTY	#	DESCRIPTION	DISCOUNT PRICE	REGULAR PRICE	TOTAL
	1	Pedestal (White) 20"L x 20"W □ 28"H or □ 36"H	\$144.00	\$214.00	
	2	Pedestal White 40"L X 40"W (Tops are 20" X 20") (Unit Heights - 16"- 28" & 28"- 40")	\$522.00	\$787.00	
	3	Storage Counter (White) 80"L X 20"W X 40"H	\$434.00	\$650.00	
	4	Curved Counter (White) 60"L X 20"W X 40"H	\$345.00	\$517.00	
	5	99A Showcase (White/Glass) 40"L X 20"W X 41"H	\$345.00	\$517.00	
	6	99B Showcase (White/Glass) 40"L X 20"W X 41"H	\$345.00	\$517.00	
	7	99C Showcase (White/Glass) 26"L X 26"W X 96"H	\$521.00	\$781.00	
	8	99D Showcase (White/Glass) 40"L X 20"W X 96"H	\$521.00	\$781.00	

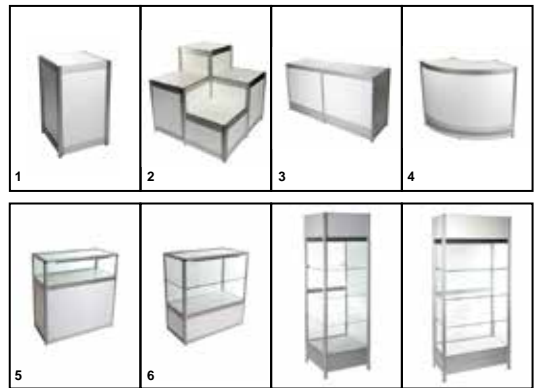

QTY	#	DESCRIPTION	DISCOUNT PRICE	REGULAR PRICE	TOTAL
	A	Waterfall With Eight Balls	\$42.00	\$64.00	
	B	Grid Panels - 38"W X 44"H White Panels (2" Squares)	\$144.00	\$214.00	
	C	Garment Rail 39"W	\$51.00	\$76.00	
	D	Shelves □ Flat □ Angled 37"L X 12"W	\$43.00	\$65.00	
	E	Slatwall Panels - 37"W X 96"H Grey (Upgrade for standard panels)	\$121.00	\$181.00	

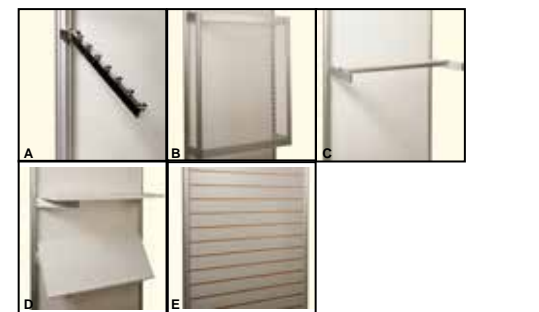

Accessories A to E are designed to fit GES Hardwall booths only

Please Attach Diagram Of Booth Indicating Locations For Grid Panels And/Or Slatwall. Grid Panels Cannot Be Installed In Corners.

Terms & Conditions

- All items subject to availability.
- No refunds/exchanges once show move-in begins.
- All claims or discrepancies must be settled prior to show closing.
- Exhibitor is responsible for all items for the duration of the show.
- Charges are for rental of equipment. All items remain the property of GES.
- All orders received after the Discount Price Date will be processed at the Regular Price.

SUBTOTAL	
13% HST	
TOTAL	
	HST #R104060264

I have read and understand the Terms & Conditions of my Agreement with GES.

Signature

Date

Our Creative Exhibit Team will design a cost-effective, turnkey exhibit that will

- Exceed your expectations
- Highlight your brand
- Attract positive attention
- Stay within your budget

Your successful Tradeshow is just a phone call or click away...

Jodi Anastasakis • 905-283-0559
 • janastasakis@ges.com

20' x 20' island



10' x 20' inline



20' x 30' island



10' x 20' corner



GES is your one stop exhibit solution partner. Take advantage of our Creative Services Department to enhance your presence on the show floor. Upgrade a show special, or design from scratch. Our team of in-house Designers & Production Technicians, can help you realize your vision quickly and affordably.



- Backlit signs
- Banners & hanging signs
- Floor/carpet decals
- Backwall murals
- Easel & freestanding signs
- Posters
- Custom cut signs & decals
- Branding graphics

Please contact Jodi Anastasakis: 905.283.0559

or email: janastasakis@ges.com



5675 McLaughlin Road, Mississauga, Ontario, L5R 3K5 Tel: 905-283-0500 Fax: 905-283-0501 Toll Free: 1-877-437-4247
torontoexhibitorservices@ges.com www.gesexpo.ca

SIGN ORDER FORM

SHOW: **AACE Annual Meeting 2016**

EXHIBITOR INFORMATION

BOOTH #: _____

COMPANY _____

STREET _____

CITY _____ PROV/STATE _____ CODE _____

E-MAIL _____

PHONE _____ FAX _____

CONTACT NAME _____

DISCOUNT PRICE DEADLINE DATE: **June 3, 2016**

CREDIT CARD AUTHORIZATION

MASTERCARD VISA AMEX

_____|_____|_____|_____|_____|_____|_____|_____|_____|_____|

EXPIRY DATE ____/____/____

CARDHOLDER NAME

CARDHOLDER SIGNATURE

CHEQUE ATTACHED (PAYABLE TO GES CANADA)

ALL ORDERS MUST BE PREPAID IN FULL (ORDERS CAN NOT BE PROCESSED UNTIL PAYMENT IS RECEIVED)

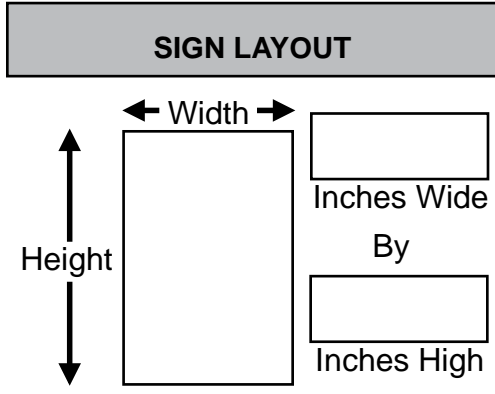

Sign Sizes	Discount Price	Regular Price
11" x 14"	\$ 42.00	\$ 63.00
14" x 22"	\$ 75.00	\$113.00
22" x 28"	\$ 98.00	\$146.00
7" x 44"	\$ 72.00	\$108.00
28" x 44"	\$125.00	\$188.00
40" x 60"	\$276.00	\$414.00

LOGOS ARE NOT INCLUDED IN PRICING

PLEASE PRINT OR TYPE WORDING REQUIRED:

ALL SIGNS MUST BE PICKED UP FROM OUR ON-SITE DESK.

Terms & Conditions

- All orders received after the Discount Price Date will be processed at the Regular Price.
- There are no refunds/exchanges on signs.
- All claims or discrepancies must be settled at the GES Service Centre prior to show closing.

SUBTOTAL	_____
13% HST	_____
TOTAL	_____
	HST #R104060264

I have read and understand the Terms & Conditions of my Agreement with GES.

Signature

Date

5675 McLaughlin Road, Mississauga, Ontario, L5R 3K5 Tel: 905-283-0500 Fax: 905-283-0501 Toll Free: 1-877-437-4247
torontoexhibitorservices@ges.com www.gesexpo.ca

SHOW: AACE Annual Meeting 2016	DISCOUNT PRICE DEADLINE DATE: June 3, 2016										
EXHIBITOR INFORMATION											
BOOTH #: _____											
COMPANY _____											
STREET _____											
CITY _____ PROV/STATE _____ CODE _____											
E-MAIL _____											
PHONE _____ FAX _____											
CONTACT NAME _____											
CREDIT CARD AUTHORIZATION											
<input type="checkbox"/> MASTERCARD <input type="checkbox"/> VISA <input type="checkbox"/> AMEX <table style="width: 100%; border-collapse: collapse;"> <tr> <td style="border: 1px solid black; width: 25px; height: 20px;"></td> <td style="border: 1px solid black; width: 25px; height: 20px;"></td> <td style="border: 1px solid black; width: 25px; height: 20px;"></td> <td style="border: 1px solid black; width: 25px; height: 20px;"></td> <td style="border: 1px solid black; width: 25px; height: 20px;"></td> <td style="border: 1px solid black; width: 25px; height: 20px;"></td> <td style="border: 1px solid black; width: 25px; height: 20px;"></td> <td style="border: 1px solid black; width: 25px; height: 20px;"></td> <td style="border: 1px solid black; width: 25px; height: 20px;"></td> <td style="border: 1px solid black; width: 25px; height: 20px;"></td> </tr> </table>											
EXPIRY DATE _____ / _____											
CARDHOLDER NAME _____											
CARDHOLDER SIGNATURE _____											
<input type="checkbox"/> CHEQUE ATTACHED (PAYABLE TO GES CANADA)											

ALL ORDERS MUST BE PREPAID IN FULL (ORDERS CAN NOT BE PROCESSED UNTIL PAYMENT IS RECEIVED)

Create a Lasting Impression!

GREEN FLOOR PLANTS					
QTY	ITEM #	DESCRIPTION	DISCOUNT PRICE	REGULAR PRICE	TOTAL
	PFP25	2 ft. to 5 ft. Tall	\$81.00	\$123.00	
	PFP68	6 ft. to 8 ft. Tall	\$160.00	\$240.00	
	PFP910	9 ft. to 10 ft. Tall (Indoor Tree)	\$240.00	\$360.00	
GREEN TABLE PLANTS					
	PBF	Boston Fern	\$60.00	\$90.00	
	PTP	Table Plant - 10"	\$60.00	\$90.00	
	PMUM	Mums	\$36.00	\$54.00	
FLOWERING PLANTS & SPECIAL REQUESTS					
	PFAS	Standard Fresh Flower Arrangement	\$117.00	\$177.00	
	PFAP	Premium Fresh Flower Arrangement	\$217.00	\$327.00	
	PFAE	Exotic Arrangement	\$149.00	\$225.00	



PLEASE NOTE: Prices for flowering plants may change depending on type of flowers requested. Please list below the types of flowers you require along with any specific instructions and our Exhibitor Service Department will check on availability and price:

Terms & Conditions

- All orders received after the Discount Price Date will be processed at the Regular Price.
- Exhibitor is responsible for all items for the duration of the show. No refunds, exchanges or cancellations on site.
- Charges are for rental of equipment only. All items remain the property of GES.
- All claims or discrepancies must be settled at the GES Service Centre prior to show closing.

SUBTOTAL	
13% HST	
TOTAL	
HST #R104060264	

I have read and understand the Terms & Conditions of my Agreement with GES.

Signature

Date

Factoring Green into Exhibition



We integrate sustainable business practices, both internally and with preferred vendors in the exhibition industry.

With the future in mind, we are dedicated to providing green product options and services to all our show organizers and exhibitors. As the need to conserve resources grows, we will continue to explore ways to deliver sustainable solutions.

Our green exhibition products:

- 100% recyclable graphics, use of bioboard (60% recycled content) and biobanner (an oxo-biodegradable alternative to vinyl)
- 100% recyclable carpet and carpet padding made with 98% pre- and post-consumer content
- Using EspressoSM, our online ordering system, for most shows reduces the use of paper exhibitor manuals

Our green operational efforts:

- Recycling carpet and padding
- Utilizing energy efficient lighting
- Recycling paper and ink cartridges from printers
- Purchasing recycled paper and signage products
- Recycling steel and aluminum exhibit structures

 Please consider the environment before printing this page.

5675 McLaughlin Road, Mississauga, Ontario, L5R 3K5 Tel: 905-283-0500 Fax: 905-283-0501 Toll Free: 1-877-437-4247
torontoexhibitorservices@ges.com www.gesexpo.ca

SHOW: AACE Annual Meeting 2016	DISCOUNT PRICE DEADLINE DATE: June 3, 2016				
EXHIBITOR INFORMATION	CREDIT CARD AUTHORIZATION				
BOOTH #: _____	<input type="checkbox"/> MASTERCARD <input type="checkbox"/> VISA <input type="checkbox"/> AMEX				
COMPANY _____	<table border="1" style="width: 100%; height: 20px; border-collapse: collapse;"> <tr> <td style="width: 25%;"></td> <td style="width: 25%;"></td> <td style="width: 25%;"></td> <td style="width: 25%;"></td> </tr> </table>				
STREET _____	EXPIRY DATE _____ / _____				
CITY _____ PROV/STATE _____ CODE _____	CARDHOLDER NAME _____				
E-MAIL _____	CARDHOLDER SIGNATURE _____				
PHONE _____ FAX _____	<input type="checkbox"/> CHEQUE ATTACHED (PAYABLE TO GES CANADA)				
CONTACT NAME _____					

EXHIBITOR MUST REPORT TO GES SERVICE CENTRE TO RECEIVE THEIR LABOUR

LABOUR RATES ARE CHARGED PER PERSON AT **A MINIMUM CHARGE OF ONE HOUR**. LABOUR OVER ONE HOUR IS CHARGED IN 1/2 HOUR INCREMENTS.
(A 30% SURCHARGE WILL BE APPLIED TO ON-SITE ORDERS)

LABOUR INSTALLATION AND DISMANTLING				
CODE	CODE	DESCRIPTION	PER HOUR	
LINREG	LOREG	Straight Time Monday-Friday 8:00am - 4:00pm	\$110.00	
LINOT	LOOT	Overtime Monday-Friday 4:00pm - 6:00pm, Saturday & Sunday 8:00am - 4:00pm	\$166.00	
LINDT	LODT	Double Time Monday-Friday After 6:00pm, Saturday & Sunday After 4:00pm, All Holiday Hours	\$215.00	

INSTALLATION	Set Up Drawings or Photos Attached: <input type="checkbox"/> yes <input type="checkbox"/> no
Carrier: _____	Delivery Date/Time: _____ AM PM <small>Day / Date/ Month / Year</small>
SUPERVISION	<input type="checkbox"/> By Exhibitor (Provide Name of Rep): _____ <input type="checkbox"/> By GES 30% surcharge applies <small>(Exhibitor <u>MUST</u> be Present to Supervise) (Exhibitor does <u>NOT</u> have to be present)</small>
DATE/TIME LABOUR REQUIRED: _____	AM PM <small>Day / Date/ Month / Year</small>
NUMBER OF PEOPLE REQUIRED _____	X HOURS PER PERSON _____ = TOTAL EST. HRS. _____
DISMANTLING	
Carrier: _____	Delivery Date/Time: _____ AM PM <small>Day / Date/ Month / Year</small>
SUPERVISION	<input type="checkbox"/> By Exhibitor (Provide Name of Rep): _____ <input type="checkbox"/> By GES 30% surcharge applies <small>(Exhibitor <u>MUST</u> be Present to Supervise) (Exhibitor does <u>NOT</u> have to be present)</small>
DATE/TIME LABOUR REQUIRED: _____	AM PM <small>Day / Date/ Month / Year</small>
NUMBER OF PEOPLE REQUIRED _____	X HOURS PER PERSON _____ = TOTAL EST. HRS. _____

Terms & Conditions

- When Exhibitor is supervising labour the Exhibitor must check labour in and out at the GES Service Centre.
- We reserve the right to change labourers and/or rates as shifts change.
- All claims or discrepancies must be settled within one week of show closing.
- Uncancelled labour will be charged a minimum fee of 1 hour per person.
- GES Limits of Liability apply.

EST. SUBTOTAL	
13% HST	
EST. TOTAL	
	HST #R104060264

I have read and understand the Terms & Conditions of my Agreement with GES.

Signature

Date

**MATERIAL HANDLING SERVICES &
SHIPPING INFORMATION**

IMPORTANT - PLEASE READ CAREFULLY

GES has been appointed by Show Management to provide Material Handling services for the **AACE Annual Meeting 2016**. Exhibitors must use GES to perform this service which includes:

- ◆ RECEIVING, DOCUMENTING AND INSPECTING YOUR SHIPMENT(S) ON ARRIVAL
- ◆ UNLOADING OF SHIPMENT(S) AT THE SHOW SITE DOCK & DELIVERY TO BOOTH
- ◆ REMOVING OF EMPTY CONTAINERS FROM BOOTH TO STORAGE AREA
- ◆ STORING YOUR EMPTY CONTAINERS IN THE STORAGE AREA
- ◆ RETURNING OF EMPTY CONTAINERS TO BOOTH AFTER SHOW CLOSING
- ◆ MOVING YOUR OUTBOUND SHIPMENT TO THE LOADING DOCK
- ◆ RELOADING OF SHIPMENT(S) FROM DOCK ON TO YOUR CARRIER

GES, as the official Material Handling contractor, is required by Show Management to perform this service. These services are charged per hundred weight with a 200 lb minimum at the expense of the exhibitor. **All Shipments must be accompanied with a Certified Weight Ticket (CWT). If no CWT is available, GES will weigh your shipment on site and special handling charges will apply. For all loose, stacked and uncrated shipments, Special Handling rates will apply.** To avoid additional charges, please complete and return the **MATERIAL HANDLING ORDER FORM** provided.

Exhibitors shipping to the advance warehouse receive the following additional services:

- ◆ STORAGE UP TO 30 DAYS IN THE ADVANCE WAREHOUSE
- ◆ DELIVERY OF SHIPMENT(S) FROM ADVANCE WAREHOUSE TO SHOW SITE
- ◆ FIRST PRIORITY UNLOADING STATUS

**** LOOSE AND UNCRATED SHIPMENT(S) WILL NOT BE RECEIVED BY ADVANCE WAREHOUSE****

LABELING YOUR PACKAGES FOR SHIPPING:

A) ADVANCE SHIPMENTS TO WAREHOUSE DEADLINE DATE: **Friday, May 27 - Friday, June 17, 2016**

NAME OF EXHIBITING COMPANY - BOOTH NUMBER
c/o **GES/**
AACE Annual Meeting 2016
6130 Netherhart Rd.
Mississauga, Ontario, Canada L5T 1B7

B) DIRECT SHIPMENTS TO SHOW SITE TARGET DATE: **Saturday, June 25, 2016 1:00 pm - 6:00 pm**
Sunday, June 26, 2016 9:00 am - 1:00 pm

NAME OF EXHIBITING COMPANY - BOOTH NUMBER
c/o **GES/**
AACE Annual Meeting 2016
Loading Dock - 100 Richmond Street
Toronto, Ontario, Canada
M5H 3K6



5675 McLaughlin Road, Mississauga, Ontario, L5R 3K5 Tel: 905-283-0500 Fax: 905-283-0501 Toll Free: 1-877-437-4247 www.gesexpo.ca
torontoexhibitorservices@ges.com www.gesexpo.ca

MATERIAL HANDLING ORDER FORM

SHOW: **AACE Annual Meeting 2016**

DISCOUNT PRICE DEADLINE DATE: **June 3, 2016**

EXHIBITOR INFORMATION

BOOTH #: _____

COMPANY _____

STREET _____

CITY _____ PROV/STATE _____ CODE _____

E-MAIL _____

PHONE _____ FAX _____

CONTACT NAME _____

CREDIT CARD AUTHORIZATION

MASTERCARD VISA AMEX

--	--	--	--	--	--	--	--	--	--

EXPIRY DATE _____ / _____

CARDHOLDER NAME _____

CARDHOLDER SIGNATURE _____

CHEQUE ATTACHED (PAYABLE TO GES CANADA)

CREDIT CARD AUTHORIZATION (ABOVE) MUST BE COMPLETED AS METHOD OF PAYMENT FOR THIS SERVICE

ADVANCE SHIPMENT(S) TO WAREHOUSE:

- Shipment(s) must be received between: **May 27th - June 17th, 2016**
- Estimated Weight of Shipment(s) - Rounded up to the nearest 100lbs:
- Rate **\$102.00** per 100lbs. (200lb. minimum) **Pounds**
- Shipments arriving without a certified weight ticket will be subject to Special Handling rates.

DIRECT SHIPMENT(S) TO SHOWSITE:

- Shipment(s) may arrive at Show Site on or after: **June 25, 1pm - 6pm & June 26, 9am - 1pm**
- Estimated Weight of Shipment(s) - Rounded up to the nearest 100lbs:
- Rate **\$87.00** per 100lbs. (200lb. minimum) **Pounds**
- Shipments arriving without a certified weight ticket will be subject to Special Handling rates.

SMALL PACKAGES: (Maximum 50lbs / Shipment):

- Rate of **\$42.00** First Package
- Rate of **\$10.00** for each additional package (in the same shipment) to a 50lb. Maximum

If over 50lbs., Rates for Advance or Direct Shipments will apply

SPECIAL HANDLING: (30% Surcharge Applies to Entire Shipment):

- All shipments of loose, padded or uncrated materials. All special unloading requirements, such as ground side door/ constricted or stacked unloading.
- All Direct and Advance Shipments without certified weight ticket or proven inaccurate weight ticket.

PLEASE COMPLETE THE FOLLOWING:

Carrier Name: _____ Number of Pieces: _____ Total Weight: _____

Goods are scheduled for delivery to: Show Site Advance Warehouse

Date goods are scheduled to arrive: _____ Month/Day _____

Terms & Conditions

- Collect shipments will not be accepted.
- GES is not responsible for concealed damage, damage to loose or inadequately packed shipments or loss of merchandise after delivery to booth.
- It is the exhibitor's responsibility to secure and maintain loss & damage insurance coverage for their exhibit properties.
- All claims or discrepancies must be settled at the GES Service Centre prior to show closing.

EST. SUBTOTAL	
13% HST	
EST. TOTAL	
HST #R104060264	

I have read and understand the Terms & Conditions of my Agreement with GES.

Signature

Date

ADVANCE WAREHOUSE SHIPPING LABEL

AACE Annual Meeting 2016

EXHIBIT SHIPMENT FOR ADVANCE WAREHOUSE

SHIPPER: _____
(Name of Company where shipment originates.)

TO: _____
(Name of your exhibiting Company at the show.)

BOOTH NUMBER: _____
(Your booth number at the show.)

C/O: GES/AACE Annual Meeting 2016
6130 Netherhart Rd.
Mississauga, Ontario, Canada
L5T 1B7

CARRIER: _____
(Name of your Transportation Company)

NUMBER **OF** **PIECES**

ADVANCE SHIPMENTS TO WAREHOUSE MUST BE RECEIVED BETWEEN:

May 27, 2016 to June 17, 2016 9am - 4pm

DIRECT TO SHOW SITE SHIPPING LABEL

AACE Annual Meeting 2016

EXHIBIT SHIPMENT FOR DIRECT TO SHOWSITE

SHIPPER: _____
(Name of Company where shipment originates.)

TO: _____
(Name of your exhibiting Company at the show.)

BOOTH NUMBER: _____
(Your booth number at the show.)

C/O: GES/AACE Annual Meeting 2016
Sheraton Centre Toronto Hotel
Loading Dock
100 Richmond Street
Toronto, Ontario, Canada
M5H 3K6

CARRIER: _____
(Name of your Transportation Company)

NUMBER **OF** **PIECES**

DIRECT SHIPMENTS TO SHOWSITE TO ARRIVE ON:
June 25, 2016 1pm - 6pm / June 26, 2016 9am - 1pm



logistics

GES Logistic Services

*GES is proud
to offer our
clients a one
source solution
for
Customs and
Transportation
services*

Your Choice of Reliable Service Options

- Time Critical Ground
- Expedited Ground
- 3-5 Day Deferred
- Common Carrier
- Van Line

24-Hour Tracking

Call toll free 1-877-437-4247 for immediate information on the status of your shipment

On-Site Representation

GES Logistics representatives will be on site from the beginning of move-in and throughout the event until the last shipment leaves the show floor

Competitive Pricing

You will benefit from priority delivery at competitive prices thanks to special arrangements we have with select carriers

Simplified Budgeting

Our transportation management system gives you the information you need to budget more effectively

Simplified Ordering

For your convenience choose one of the ordering options available:

- Online: www.gesexpo.ca
- Phone: 905-283-0500 or 1-877-437-4247
- Fax: 905-283-0501

Ship everywhere with GES Logistics Services.

It's (almost) show time! Are you ready?

GES offers many products and services to help you achieve the results you are looking for. Have you considered...

GES Logistics Services *Local, Regional, International*

- ✈ **Transportation**
- 🌐 **Tracking & Tracing**
- 🔒 **Warehousing**
- ☑ **Exhibit Management**

Let GES Logistics handle the details. We smoothly navigate the many challenges of event management from shipping to tracking to warehousing and more.

Our **GES** Logistics team offers you **one-stop shopping for all your tradeshow and event needs.**

Transportation management you can rely on.

With **GES** Logistics, you have a variety of shipping options:

- Common Carrier
- LTL trucking to handle national, regional and local shipping
- Full truck load for economy
- Air, including second-day and deferred

Want to find out more?

Call toll free at 1 877 437-4247 (x573) or complete information below and fax to (905) 283-0501, and let GES take care of your logistics needs from start to finish.

Company Name:	Phone:
Contact:	Fax:



5675 McLaughlin Road, Mississauga, Ontario, L5R 3K5 Tel: 905-283-0500 Fax: 905-283-0501 Toll Free: 1-877-437-4247
torontoexhibitorservices@ges.com www.gesexpo.ca

SHIPPING ORDER FORM

PICK UP INFORMATION

COMPANY NAME: _____ PICK UP DATE: _____ PICK UP TIME: _____
 ADDRESS: _____ BUSINESS HOURS: _____ LOADING DOCK: YES NO
 CITY: _____ PROV/STATE: _____ CODE: _____ CUSTOMS PAPERWORK ATTACHED: YES NO
 CONTACT: _____ IF YES, CUSTOMS BROKER: _____
 PHONE: _____ CONTACT: _____
 FAX: _____ EMAIL: _____ PHONE: _____

I will be shipping to: ADVANCED WAREHOUSE SHOW SITE

DESTINATION

COMPANY NAME: _____ BOOTH #: _____
 ON-SITE CONTACT: _____
 SHOW NAME: **AACE Annual Meeting 2016** DELIVERY DATE: _____ DELIVERY TIME: _____
 FACILITY: **Sheraton Centre Toronto Hotel - Loading Dock**
 ADDRESS: **100 Richmond Street**
 CITY: **Toronto** PROV/STATE: **Ontario** POSTAL CODE: **M5H 3K6**

SERVICE REQUIRED

ONE WAY ROUND TRIP
 SAME DAY OVERNIGHT 2ND DAY 3-5 DAY GROUND

ITEMS TO BE SHIPPED

SERVICE WILL BE CHARGED ON **ACTUAL** WEIGHT & DIMENSIONS

TOTAL NUMBER OF PIECES:	DIMENSIONS IN INCHES:	ESTIMATED WEIGHT:
_____ CARTONS (CARDBOARD)	H _____ x W _____ x L _____	
_____ CASES/TRUNKS (FIBRE) COLOUR: _____	H _____ x W _____ x L _____	
_____ CRATES (WOODEN)	H _____ x W _____ x L _____	
_____ SKIDS/PALLETS	H _____ x W _____ x L _____	
_____ CARPET/COLOUR: _____	H _____ x W _____ x L _____	
_____ OTHER LIST: _____	H _____ x W _____ x L _____	
_____ TOTAL	TOTAL WEIGHT:	

BILLING AND PAYMENT INFORMATION

COMPANY NAME: _____ ADDRESS: _____ CITY: _____
 PROV/STATE: _____ CODE: _____ EMAIL: _____ TEL: _____ FAX: _____
 CREDIT CARD NUMBER: _____ EXPIRY DATE: _____
 VISA MASTERCARD AMERICAN EXPRESS
 CARDHOLDER NAME: _____ CARDHOLDER SIGNATURE: _____

TERMS & CONDITIONS

GES assumes no responsibility for shipments left in booth by exhibitor. All materials are subject to final count and correction at time of actual removal from booth. Shipper hereby designates GES as its agent for tendering shipments to carrier. GES reserves the right to reroute any outgoing shipment via an alternate carrier in the event the requested carrier fails to pick up the shipment by established carrier check-in deadline. GES assumes no responsibility for misdirected shipments as a result of old shipping labels which remain on containers. It is the shipper's responsibility to state the national motor freight classification commodity description, otherwise shipment shall be described as exhibition materials.

1) GES shall not be responsible for damage to uncrated materials, materials improperly packed, or concealed damage. 2) GES shall not be responsible for loss, theft, or disappearance of exhibitors material after same has been delivered to exhibitor's booth. 3) GES shall not be responsible for loss, theft, or disappearance of materials before they are picked up from exhibitor's booth for reloading after the show. Bill of Lading covering outgoing shipments, which are furnished by GES to exhibitors, will be checked at time of actual pick-up from booth and corrections made where discrepancies occur. 4) GES shall not be responsible for any loss, damage, or delay due to fire, acts of God, strikes, lockouts or work stoppages of any kind, or to any causes beyond its control. 5) GES's liability shall be limited to the physical loss or damage to the specific article which is lost or damaged, and in any event GES's maximum liability shall be limited to \$0.30 per pound per article with a maximum liability of \$50.00 per item, or \$1,000.00 per shipment, whichever is less. 6) GES shall not be liable to any extent whatsoever for any actual, potential, or assumed losses of profits or revenues, or for any collateral costs, which may result from any loss or damage to an exhibitor's materials which may make it impossible or impractical to exhibit same. 7) The consignment or delivery of a shipment to GES by an exhibitor, or by any shipper to or on behalf of the exhibitor, shall be construed as an acceptance by such exhibitor (and/or other shipper) of the terms and conditions set forth. Exhibitor is responsible to declare all hazardous materials and abide by all federal, state and local laws.

By signing this order form, shipper agrees to be bound by all its terms and conditions.

X _____ Date: _____

Please Print Name: _____



customs

*GES is proud
to offer our
clients a one
source solution
for
Customs and
Transportation
services*

GES Customs Services

Reliable and Efficient Service

- Experienced and reliable staff you can depend on who specialize in trade show Customs procedures
- Personnel are accessible at all times

Value Added Service

- Save time and money by making fewer calls

Personalized Service

- Telephone, email and fax communication
- Forms and instructions for completion in all Exhibitor Service Kits
- One-on-one Customs consultation to assist all exhibitors with their specific needs

On-Site Representation

GES Customs Services representatives will be on site from the beginning of move-in and throughout the event until the last shipment leaves the trade show floor

Simplified Ordering

For your convenience choose one of the ordering options available:

- Online: www.gesexpo.ca
- Phone: 905-283-0500 or 1-877-437-4247
- Fax: 905-283-0501

Leave all your shipping, customs clearance and furniture rentals to GES.



Customs / Transportation Order Form

EXAMPLE

THE ORIGINAL OF THIS ORDER FORM MUST BE COMPLETED & RETURNED TO ENSURE CUSTOMS CLEARANCE
PLEASE ACCEPT THIS AS YOUR AUTHORITY TO PROVIDE CUSTOMS CLEARANCE AND/OR TRANSPORTATION SERVICES

WE WISH TO USE GES SERVICES
FOR (PLEASE CHECK ONE)

Customs Clearance
And Transportation

Customs Clearance
Only

Transportation
Only

SECTION 1 EXHIBITOR AND SHIPMENT INFORMATION

Exhibitor / Company Name: ABC MACHINE COMPANY Email Address: _____

U.S. Tax # or U.S. IRS ID #: 31-2293941

Event Name & Booth #: INTERNATIONAL MACHINERY SHOW Booth #: 1430

Facility Name: MTCC - METRO TORONTO CONVENTION CENTRE - SOUTH BLDG

Shipment Date: MARCH 3, 2001 From (City): NEW YORK Carrier Name: GES LOGISTICS

It Consists of (# Cartons): 6 Weight: 1,500 lbs. kgs.

Our Rep @ Event: BILL SMITH Staying At (Hotel): RYH - ROYAL YORK Tel: 416-368-2511

PLEASE DO NOT SHIP BY PARCEL COURIER OR MAIL - WE WILL NOT BE RESPONSIBLE FOR TIMELY DELIVERY

SECTION 2 RETURN SHIPMENT CONSIGNMENT INFORMATION

Company Name: ABC MACHINE COMPANY

Delivery Address: 100 - 5TH AVENUE

City: NEW YORK Province/State: NEW YORK Postal / Zip: 10012-1010

Name: JOE BROWN Telephone: 212-286-2140 Fax Number: 212-286-2100

Ship Via: Common Carrier Our Company Vehicle Van Line Service Air Freight Service

SECTION 3 CREDIT CARD AUTHORIZATION (NOTE - THIS SECTION MUST BE COMPLETED)

I hereby authorize use of the following credit card for payment of services relative to this order form

CREDIT CARD INFORMATION MUST BE COMPLETED

Charge To: VISA MASTERCARD AMERICAN EXPRESS

Credit Card Number: 123 456 789 012 Expiry: 09 / 03

Cardholder's Name: BILL SMITH Title: DIRECTOR OF SALES

Cardholder's Signature: BILL SMITH

ORIGINAL SIGNATURE REQUIRED

SECTION 4 INVOICE / STATEMENT INFORMATION

Company Name: ABC MACHINE COMPANY

Mailing Address: 100 - 5TH AVENUE

City: NEW YORK Province/State: NY Postal / Zip: 10012-1010

Attention: BILL SMITH Telephone: 212-286-2140 Fax Number: 212-286-2100

SECTION 5 ORDER AUTHORIZED BY

This Form Was Completed By: JOE BROWN
(Please Print Full Name)

Title: DIRECTOR OF MARKETING

Date: APRIL 17, 2001



Customs / Transportation Order Form

THE ORIGINAL OF THIS ORDER FORM MUST BE COMPLETED & RETURNED TO ENSURE CUSTOMS CLEARANCE
PLEASE ACCEPT THIS AS YOUR AUTHORITY TO PROVIDE CUSTOMS CLEARANCE AND/OR TRANSPORTATION SERVICES

WE WISH TO USE GES SERVICES FOR (PLEASE CHECK ONE) Customs Clearance And Transportation Customs Clearance Only Transportation Only

SECTION 1 EXHIBITOR AND SHIPMENT INFORMATION

Exhibitor / Company Name: _____ Email Address: _____
U.S. Tax # or U.S. IRS ID #: _____
Event Name & Booth #: _____ Booth #: _____
Facility Name: _____
Shipment Date: _____ From (City): _____ Carrier Name: _____
It Consists of (# Cartons): _____ Weight: _____ lbs. kgs.
Our Rep @ Event: _____ Staying At (Hotel): _____ Tel: _____

PLEASE DO NOT SHIP BY PARCEL COURIER OR MAIL - WE WILL NOT BE RESPONSIBLE FOR TIMELY DELIVERY

SECTION 2 RETURN SHIPMENT CONSIGNMENT INFORMATION

Company Name: _____
Delivery Address: _____
City: _____ Province/State: _____ Postal / Zip: _____
Name: _____ Telephone: _____ Fax Number: _____
Ship Via: Common Carrier Our Company Vehicle Van Line Service Air Freight Service

SECTION 3 CREDIT CARD AUTHORIZATION (NOTE - THIS SECTION MUST BE COMPLETED)

I hereby authorize use of the following credit card for payment of services relative to this order form

CREDIT CARD INFORMATION MUST BE COMPLETED

Charge To: VISA MASTERCARD AMERICAN EXPRESS
Credit Card Number: _____ Expiry: _____ / _____
Cardholder's Name: _____ Title: _____
Cardholder's Signature: _____

ORIGINAL SIGNATURE REQUIRED

SECTION 4 INVOICE / STATEMENT INFORMATION

Company Name: _____
Mailing Address: _____
City: _____ Province/State: _____ Postal / Zip: _____
Attention: _____ Telephone: _____ Fax Number: _____
Email: _____

SECTION 5 ORDER AUTHORIZED BY

This Form Was Completed By: _____
(Please Print Full Name)
Title: _____ Date: _____

CANADA CUSTOMS INVOICE / FACTURE DES DOUANES CANADIENNES

<p>1 Vendor (Name and Address) / Vendeur (Nom et Adresse)</p> <p>ABC MACHINE COMPANY 100-5TH AVENUE NEW YORK, NY 10012-1010</p>	<p>2 Date of Direct Shipment to Canada Date d'expédition directe vers le Canada MARCH 3, 2001</p> <p>3 Other References (Include Purchaser's Order No.) Autres références (inclure le no de commande de l'acheteur) 31-2293941 (COMPANY IRS#)</p>
--	--

<p>4 Consignee (Name and Address) / Destinataire (Nom et Adresse)</p> <p>ABC MACHINE COMPANY / BOOTH 210 INTERNATIONAL MACHINERY SHOW C/O METRO TORONTO CONVENTION CENTRE SOUTH BLDG 222 BREMNER BLVD TORONTO, ON M5V 2E6</p>	<p>5 Purchaser's Name and Address (if other than Consignee) Nom et Adresse de l'acheteur (s'il diffère du destinataire) NO SALE INVOLVED</p> <p>6 Country of Transshipment / Pays de transbordement N/A</p> <p>7 Country of Origin of Goods Pays d'origine des marchandises U.S.A.</p> <p style="font-size: small;">If shipment includes goods of different origins enter origins against items in 12 Si l'expédition comprend des marchandises d'origines différentes, en préciser la provenance en 12</p>
--	--

<p>VII. 1 Is this a related company transaction? Est-ce que les compagnies sont liées entre elles?</p> <p>YES <input type="checkbox"/> OUI NO <input type="checkbox"/> NON</p>	<p>9 Condition of Sales and Terms of Payment (i.e. Sale, Consignment Shipment, Leased Goods, etc.) Conditions de vente et modalités de paiement (p. Ex. Vente, Expédition en consignation, location de marchandises, etc.)</p>
---	--

<p>8 Transportation: Give Mode and Place of Direct Shipment to Canada Transport: Préciser mode et lieu d'expédition directe vers le Canada</p> <p>GES LOGISTICS NEW YORK, NY</p>	<p>10 Currency of Settlement / Devises du paiement USD</p>
--	--

11. No. of Pkgs. / Nbre. de colis	12. Specification of Commodities (Kind of Packages) Marks and Numbers, General Description and Characteristics i.e. Grade Quality / Designation des articles (Nature des colis, marques et numéros, description générale et caractéristiques. P. Ex. Classe, qualité)	13. Quantity (State Unit) / Quantité (Préciser l'unité)	Relacement Value / Valeur de Remplacement	
			14. Unit Price / Prix Unitaire	15. Total
3 PCS	WOODEN CRATES-COMPUTERS (CERTIFICATE OF REGISTRATION ATTACHED)	3	\$1,000.00	\$3,000.00
1 PC	CRATE-COMPUTER MONITOR (CERTIFICATE OF REGISTRATION ATTACHED)	1	\$ 500.00	\$ 500.00
1 PC	CARTON-ADVERTISING LITERATURE	1,000	\$ 0.10	\$ 100.00
1 PC	CARTON-PLASTIC KEY CHAINS / BOOKS	50	\$ 0.50	\$ 25.00

<p>XI.1 Total Number of Pieces / Nombre total de pièces 6</p>		
<p>18 <input type="checkbox"/> If any fields of 1 to 17 are included on an attached commercial invoice, check this box / Si les renseignements des zones 1 à 17 figurent sur la facture commerciale cocher cette case</p> <p>Commercial Invoice No. / No. De la facture commerciale</p>	<p>16. Total Weight / Poids total 1,500bs. <input checked="" type="checkbox"/>kgs.</p>	<p>17. Invoice Total / Total de la facture</p>
	<p>Net. Weight / N/A</p>	<p>Gross Wt./ Brut / 1,500 lbs</p>

<p>19 Exporter's Name and Address (if other than Vendor) Nom et adresse de l'exportateur (s'il diffère du vendeur)</p>	<p>20 Originator (Name and Address) Expéditeur d'origine (Nom et adresse) ABC MACHINE COMPANY 100-5TH AVENUE NEW YORK, NY 10012-1010</p> <p>Contact: BILL SMITH</p> <p>Tel: 212-268-2140 Fax: 212-268-2511</p>
<p>21 Departmental Ruling (if applicable) Decision ministérielle (s'il y a lieu)</p> <p>N/A</p>	

CANADA CUSTOMS INVOICE / FACTURE DES DOUANES CANADIENNES

1 Vendor (Name and Address) / Vendeur (Nom et Adresse)		2 Date of Direct Shipment to Canada Date d'expédition directe vers le Canada		3 Other References (Include Purchaser's Order No.) Autres références (inclure le no de commande de l'acheteur)	
4 Consignee (Name and Address) / Destinataire (Nom et Adresse)		5 Purchaser's Name and Address (if other than Consignee) Nom et Adresse de l'acheteur (s'il diffère du destinataire)			
		6 Country of Transshipment / Pays de transbordement			
		7 Country of Origin of Goods Pays d'origine des marchandises		If shipment includes goods of different origins enter origins against items in 12 Si l'expédition comprend des marchandises d'origines différentes, en préciser la provenance en 12	
VII. 1 Is this a related company transaction? Est-ce que les compagnies sont liées entre elles? YES <input type="checkbox"/> OUI NO <input type="checkbox"/> NON		9 Condition of Sales and Terms of Payment (i.e. Sale, Consignment Shipment, Leased Goods, etc.) Conditions de vente et modalités de paiement (p. Ex. Vente, Expédition en consignation, location de marchandises, etc.)			
8 Transportation: Give Mode and Place of Direct Shipment to Canada Transport: Préciser mode et lieu d'expédition directe vers le Canada		10 Currency of Settlement / Devises du paiement			
11. No. of Pkgs. Nbre. de colis	12 Specification of Commodities (Kind of Packages) Marks and Numbers, General Description and Characteristics i.e. Grade Quality Designation des articles (Nature des colis, marques et numéros, description générale et caractéristiques. P. Ex. Classe, qualité)	13 Quantity (State Unit) Quantité (Préciser l'unité)	Relacement Value Valeur de Remplacement		
			14 Unit Price Prix Unitaire	15 Total	
XI.1 Total Number of Pieces / Nombre total de pièces					
18 <input type="checkbox"/> If any fields of 1 to 17 are included on an attached commercial invoice, check this box / Si les renseignements des zones 1 à 17 figurent sur la facture commerciale cocher cette case Commercial Invoice No. / No. De la facture commerciale		16. Total Weight / Poids total <input type="checkbox"/> lbs. <input type="checkbox"/> kgs.		17. Invoice Total Total de la facture	
		Net. Weight	Gross Wt./ Brut		
19 Exporter's Name and Address (if other than Vendor) Nom et adresse de l'exportateur (s'il diffère du vendeur)		20 Originator (Name and Address) Expéditeur d'origine (Nom et adresse)			
21 Departmental Ruling (if applicable) Decision ministérielle (s'il y a lieu)		Contact: Tel: Fax:			