

GES is pleased to have been selected the official service contractor by the Show Organizer to design and produce your show. Our goal is to ensure your show participation is a success.

GES is involved in many areas relative to the show and if at any time during the planning process you are unsure where to turn, just ask us, we are at your service.

Please ensure that you review this section carefully as it contains information, **DISCOUNT PRICES** and order forms for each of the many services being provided by **GES**.

For your convenience, we will be offering the following services:

- ✓ Online Ordering
- ✓ Furnishings
- ✓ Carpet & Underpadding
- ✓ GEM Exhibits & Accessories
- ✓ Signs & Graphics
- ✓ Plants
- ✓ Installation & Dismantling Labour
- ✓ Material Handling
- ✓ GES Logistics / Shipping
- ✓ GES Customs

To take advantage of our **DISCOUNT PRICING**, all order forms and full payment must be received on or before the Discount Date of March 25 as indicated on each form. **GES** accepts Visa, Mastercard, American Express, Cheques and Cash as methods of payment for our services. All exhibitors are responsible for payment of G.S.T. when exhibiting in Alberta.

If you need assistance or additional information, please contact our **Exhibitor Services Department at (403) 243-2212.**



Accelerate your experience with Expresso exhibit planning, ordering and management.

Exhibitors can order everything they need for their tradeshow exhibit through Expresso, our simple to navigate, picture-driven system that satisfies your need for speed. With just a few clicks exhibitors can order GES products and services including:

- Booth furniture.
- Carpet and flooring.
- Material handling.
- Booth labour.
- And much more.

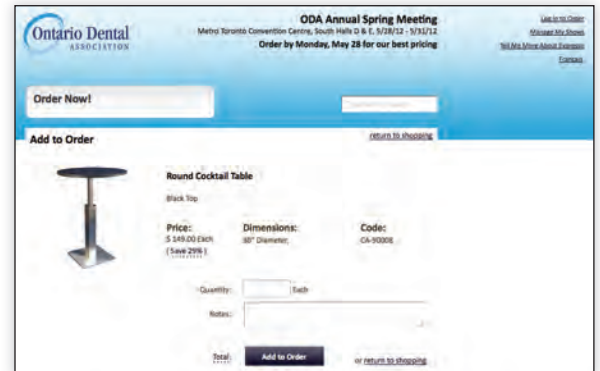

Expresso is more than just an online exhibitor manual. Exhibitors can:

- Order exhibit products and services.
- Print shipping labels.
- View important show and event information.
- Download the show schedule into Outlook or iCalendar.
- View account order status and history.



Experience a difference with Expresso.

- Each show has their own custom website.
- Runs on all browsers for PCs, Macs and tablets.
- Everything in one place; all organizer and show information, ordering and even third party forms.
- Keeps you on-time and on-budget.



SHOW: Canadian Imaging Conference & Tradeshow

EXHIBITOR INFORMATION

BOOTH #: _____

COMPANY _____

STREET _____

CITY _____ PROV/STATE _____ CODE _____

E-MAIL _____

PHONE _____ FAX _____

CONTACT NAME _____

IMPORTANT - READ CAREFULLY

Please fill out The Credit Card Authorization below if:

- You or your company are forwarding payment to GES in the form of a cheque.
- There is any possibility you or your representative will be ordering any service on-site.
- You are ordering Material Handling, Installation and Dismantle Labour or In-Booth Forklift Services.

PLEASE COMPLETE THE FOLLOWING

MASTERCARD
 VISA
 AMERICAN EXPRESS
 EXPIRY DATE:

CORPORATE
 PERSONAL

CARD #

CARDHOLDER'S NAME (PRINT): _____

CARDHOLDER'S SIGNATURE: _____

Cardholder's Billing Address: _____

City: _____ Prov/State: _____ Code/Zip: _____

Tel: _____ Fax: _____

This authorization allows GES to charge any fees outstanding after show closing to this credit card (including funds owed due to a cheque returned NSF)

CHEQUES WILL NOT BE ACCEPTED WITHOUT THIS CREDIT CARD AUTHORIZATION

IF THIS AUTHORIZATION IS NOT COMPLETED, ALL ON-SITE ORDERS ARE EXPECTED TO BE PAID IN FULL BEFORE DELIVERY

TO: **GES**
FAX: **(403) 243-3868**
DATE: _____
FROM: _____
SHOW NAME: _____
COMPANY: _____
BOOTH #: _____

✓ To help us ensure we have received your entire order, please check off those forms you are sending us:

- Third Party Billing
- Credit Card Authorization
- Furnishings
- Carpet & Underpadding
- Exhibit Accessories
- Signs
- Plants
- Installation & Dismantle Labour Services
- Material Handling
- GES Logistics / Shipping

Please call to confirm receipt of your order.

***To receive Discount Pricing send your order in
by the Discount Price Deadline Date - March 25, 2016***

Thank you from GES



SHOW: Canadian Imaging Conference & Tradeshow

EXHIBITOR INFORMATION

BOOTH #: _____

COMPANY _____

STREET _____

CITY _____ PROV/STATE _____ CODE _____

E-MAIL _____

PHONE _____ FAX _____

CONTACT NAME _____

You may arrange for an exhibit house or other agent to handle your display & be charged for services. GES will agree to this arrangement if the exhibit house or agent makes satisfactory payment arrangements with us. Both firms must complete this form and return to GES by the Advanced Price Deadline Date. It is understood and agreed that the exhibitor is ultimately responsible for payment of charges. If your named third party has not paid the invoice before the last day of the show, any outstanding balance will be charged to the exhibitor's credit card.

Exhibiting Company

Name of Exhibiting Company _____ Phone # _____ Fax # _____

Address _____ City _____ Prov/State _____ Code/Zip _____

Authorized Name (print) _____ Authorized Signature _____

CREDIT CARD AUTHORIZATION

MASTERCARD VISA AMERICAN EXPRESS CORPORATE PERSONAL

EXPIRY DATE: _____

CARD #

Cardholder's Name (print) _____ Cardholder's Signature _____

Third Party / Exhibit House

Name of Third Party/Exhibit House _____ Phone # _____ Fax # _____

Address _____ City _____ Prov/State _____ Code/Zip _____

Authorized Name (print) _____ Authorized Signature _____

CREDIT CARD AUTHORIZATION

MASTERCARD VISA AMERICAN EXPRESS CORPORATE PERSONAL

EXPIRY DATE: _____

CARD #

Cardholder's Name (print) _____ Cardholder's Signature _____

ALL GES SERVICES ARE TO BE CHARGED TO THE THIRD PARTY EXCEPT FOR THE FOLLOWING:

DISCOUNT PRICING:

To qualify for **Discount Pricing**, orders must be received **with payment in full on or before the deadline date.** Late orders will be charged the **Regular Prices.** Orders without payment cannot be processed until payment is received and could be charged the **Regular Price.**

METHOD OF PAYMENT:

GES accepts American Express, MasterCard, Visa, Debit Card, Cheque and Bank Wire Transfers. Purchase Orders are not considered payment. **Exhibitors will be charged a \$25.00 fee for returned NSF cheques.**

BANK WIRE TRANSFER INFORMATION:

To properly credit your account, please complete the **BANK WIRE TRANSFER FORM** included with the GES order forms and send the following information to the GES Exposition Services (Canada) Limited address listed on the Bank Wire Transfer Form.

NOTE: There is a minimum \$20.00 Service Charge (North America) \$40.00 (International) applicable on all wire transfers. Fees vary depending on banks processing wire transfers.

PAYMENT SCHEDULE:

Payment for all services must be pre-paid in full. GES will not provide Material Handling, In-Booth Forklifts, or Installation and Dismantle Labour Services without your company's **CREDIT CARD AUTHORIZATION FORM** on file.

THIRD PARTY BILLING:

You may arrange for an exhibit house or other agent to manage your exhibit & order services on your behalf. GES will agree to this arrangement if the exhibit house or agent makes satisfactory payment arrangements with us. In the event the authorized Third Party does not pay, each exhibiting company is ultimately responsible for all charges incurred on its behalf. See **THIRD PARTY BILLING REQUEST FORM.**

ADJUSTMENTS AND CANCELLATIONS:

Adjustments to your invoice **will not be made after the close of the show.** Some items, services and labour are subject to cancellation fees. Refer to each order form for details.

ALL EXHIBITORS MUST PAY 5% GST ON ALL ORDERS.



furnishings

Grey Fabric Side Chair



Grey Fabric Counter Stool



Grey Fabric Arm Chair



Steno Chair



30" Round / 30" High Pedestal Table



30" Round / 18" High Coffee Table



4', 6', OR 8' Long Raised Draped Table with White Vinyl Top



4', 6', OR 8' Long Draped Table with White Vinyl Top





furnishings

Coat Tree



22" W X 28" H
Chrome Sign Holder
(sign extra)



Easel



Gold Ballot Drum

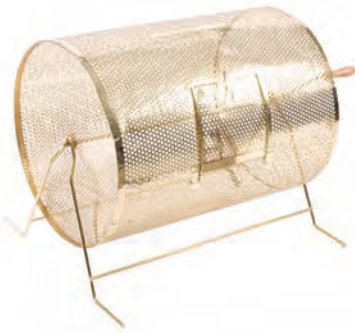

Plexi Pocket



40" W x 20" D x 36" H
White Counter Storage Unit



Bag Holder 41"H



Stanchions
6" Belt



Plastic
Wastebasket



FURNISHINGS ORDER FORM

#3030 - 2600 Portland St. SE Calgary, Alberta, T2G 4M6 Tel: (403) 243-2212 Fax: (403) 243-3868 Toll Free 1-800-636-8235 www.gesexpo.ca

SHOW: Canadian Imaging Conference & Tradeshow

DISCOUNT PRICE DEADLINE DATE:

March 25, 2016

EXHIBITOR INFORMATION

BOOTH #: _____

COMPANY _____

STREET _____

CITY _____ PROV/STATE _____ CODE _____

E-MAIL _____

PHONE _____ FAX _____

CONTACT NAME _____

CREDIT CARD AUTHORIZATION

MASTERCARD VISA AMEX

--	--	--	--	--	--	--	--

EXPIRY DATE _____ / _____

CARDHOLDER NAME _____

CARDHOLDER SIGNATURE _____

CHEQUE ATTACHED (PAYABLE TO GES)

ALL ORDERS MUST BE PREPAID IN FULL (ORDERS CANNOT BE PROCESSED UNTIL PAYMENT IS RECEIVED)

FURNISHINGS				
QTY	DESCRIPTION	DISCOUNT PRICE	REGULAR PRICE	TOTAL
	Grey Fabric Side Chair	\$37.00	\$52.00	
	Grey Fabric Counter Stool	\$81.00	\$113.00	
	Grey Fabric Arm Chair	\$38.00	\$53.00	
	Steno Chair	\$60.00	\$84.00	
	Cocktail Table 40" High	\$85.00	\$119.00	
	30" Round 30" High Pedestal Table	\$71.00	\$99.00	
	30" Round 18" High Coffee Table	\$54.00	\$76.00	
	Coat Tree	\$33.00	\$46.00	
	22" x 28" Chrome Sign Holder (Sign Extra)	\$46.00	\$64.00	
	Easel	\$39.00	\$55.00	
	Ballot Drum	\$71.00	\$99.00	
	Garment Rack on Wheels	\$44.00	\$62.00	
	White Counter Storage Unit 40" H	\$133.00	\$186.00	
	Bag Holder 41"H	\$65.00	\$91.00	
	Tape Stanchion	\$41.00	\$57.00	
	Wastebasket	\$22.00	\$31.00	

DRAPED DISPLAY TABLES 30" HIGH

BLACK BLUE BURGUNDY GREEN RED SILVER WHITE

QTY	DESCRIPTION	DISCOUNT PRICE	REGULAR PRICE	TOTAL
	4 Ft. Long x 2 Ft. Wide	\$81.00	\$113.00	
	6 Ft. Long x 2 Ft. Wide	\$90.00	\$126.00	
	8 Ft. Long x 2 Ft. Wide	\$97.00	\$136.00	
	Drape Fourth Side	Add \$35.00 ea.		

RAISED DRAPED DISPLAY TABLES 42" HIGH

BLACK BLUE SILVER WHITE

QTY	DESCRIPTION	DISCOUNT PRICE	REGULAR PRICE	TOTAL
	4 Ft. Long x 2 Ft. Wide	\$93.00	\$130.00	
	6 Ft. Long x 2 Ft. Wide	\$114.00	\$160.00	
	8 Ft. Long x 2 Ft. Wide	\$140.00	\$196.00	
	Drape Fourth Side	Add \$35.00 ea.		

CUSTOM BOOTH DRAPING

BLACK BLUE RED SILVER WHITE

	3 Ft. High (Per Linear Ft.)	\$6.90	\$9.65	
	8 Ft. High (Per Linear Ft.)	\$7.40	\$10.35	

Terms & Conditions

- All orders received after the Discount Price Date will be processed at the Regular Price.
- Exhibitor is responsible for all items for the duration of the show.
- If a colour is not chosen, GES will choose a colour for you.
- Charges are for rental of equipment only. All items remain the property of GES.
- GES is not responsible for exhibit materials left in GEM rental exhibits or counter storage units.
- All claims or discrepancies must be settled at the GES Service Centre prior to show closing.
- No refunds/exchanges on cancelled draped tables or custom booth draping once delivered. 50% refund on furnishings cancelled prior to show opening.

SUBTOTAL	
5% GST	
TOTAL	
GST #R104060264	

I have read and understand the Terms & Conditions of my Agreement with GES.

Signature

Date

CARPET ORDER FORM

#3030 - 2600 Portland St. SE Calgary, Alberta, T2G 4M6 Tel: (403) 243-2212 Fax: (403) 243-3868 Toll Free 1-800-636-8235 www.gesexpo.ca

SHOW: Canadian Imaging Conference & Tradeshow

EXHIBITOR INFORMATION

BOOTH #: _____

COMPANY _____

STREET _____

CITY _____ PROV/STATE _____ CODE _____

E-MAIL _____

PHONE _____ FAX _____

CONTACT NAME _____

DISCOUNT PRICE DEADLINE DATE: March 25, 2016

CREDIT CARD AUTHORIZATION

MASTERCARD VISA AMEX

--	--	--	--	--	--	--	--	--	--

EXPIRY DATE ____ / ____

CARDHOLDER NAME _____

CARDHOLDER SIGNATURE _____

CHEQUE ATTACHED (PAYABLE TO GES)

**ALL ORDERS MUST BE PREPAID IN FULL
(ORDERS CAN NOT BE PROCESSED UNTIL PAYMENT IS RECEIVED)**

BOOTH CARPET - STANDARD SIZE
Note: Exhibitors ordering multiple pieces of carpet in this section may not receive the same dyelot.

QTY.	DESCRIPTION	DISCOUNT PRICE	REGULAR PRICE	TOTAL
	10 Ft. X 10 Ft. Single Booth	\$153.00	\$214.00	
	10 Ft. X 20 Ft. Double Booth	\$308.00	\$431.00	

COLOUR SELECTION: BLACK BLUE GREY RED

BOOTH CARPET - CUSTOM SIZE
If your booth requires a size not listed above, please complete this section.

BOOTH SIZE: ____ Ft. x ____ Ft. = ____ Sq. Ft. \$1.53/Sq. Ft. \$2.14/Sq. Ft.

COLOUR SELECTION: BLACK BLUE GREY RED

UNDERPADDING PRICE PER SQUARE FOOT INSTALLED (100 SQ. FT. MIN.)

BOOTH SIZE: ____ Ft. x ____ Ft. = ____ Sq. Ft. \$1.03/Sq. Ft. \$1.44/Sq. Ft.

PROTECTIVE PLASTIC COVERING PRICE PER SQUARE FOOT INSTALLED (STANDARD SIZES ONLY)

BOOTH SIZE: ____ Ft. x ____ Ft. = ____ Sq. Ft. \$0.23/Sq. Ft. \$0.32/Sq. Ft.

PLEASE SELECT ONE FOR CUSTOM CARPET SIZES ONLY

IF ORDERING ELECTRICAL OR TELECOMMUNICATIONS SERVICES, WILL UNDER CARPET WIRING BE REQUIRED?

YES NO

Terms & Conditions

- All orders received after the Discount Price Date will be processed at the Regular Price.
- Exhibitor is responsible for all items for the duration of the show.
- No refunds/exchanges on carpets once delivered.
- Charges are for rental of equipment only. All items remain the property of GES.
- All claims or discrepancies must be settled at the GES Service Centre prior to show closing.
- If a colour is not chosen, GES will choose a colour for you. *Carpet colour subject to availability.*

SUBTOTAL	
5% GST	
TOTAL	
GST #R104060264	

I have read and understand the Terms & Conditions of my Agreement with GES.

Signature _____ Date

BOOTH CLEANING ORDER FORM

#3030 - 2600 Portland St. SE Calgary, Alberta, T2G 4M6 Tel: (403) 243-2212 Fax: (403) 243-3868 Toll Free 1-800-636-8235 www.gesexpo.ca

SHOW: Canadian Imaging Conference & Tradeshow	DISCOUNT PRICE DEADLINE DATE: March 25, 2016				
EXHIBITOR INFORMATION					
BOOTH #: _____					
COMPANY _____					
STREET _____					
CITY _____ PROV/STATE _____ CODE _____					
E-MAIL _____					
PHONE _____ FAX _____					
CONTACT NAME _____					
CREDIT CARD AUTHORIZATION					
<input type="checkbox"/> MASTERCARD <input type="checkbox"/> VISA <input type="checkbox"/> AMEX					
<table border="1" style="width:100%"> <tr> <td style="width:25%"> </td><td style="width:25%"> </td><td style="width:25%"> </td><td style="width:25%"> </td> </tr> </table>					
EXPIRY DATE ____ / ____					
CARDHOLDER NAME _____					
CARDHOLDER SIGNATURE _____					
<input type="checkbox"/> CHEQUE ATTACHED (PAYABLE TO GES)					

**ALL ORDERS MUST BE PREPAID IN FULL
(ORDERS CAN NOT BE PROCESSED UNTIL PAYMENT IS RECEIVED)**

INITIAL CLEANING SERVICES	DAILY CLEANING SERVICES	ADDITIONAL CLEANING SERVICES
Performed evening prior to show opening • Carpets vacuumed	Performed prior to show opening and every night at show close for duration of show • Carpets vacuumed • Wastebaskets emptied	Performed upon request • For carpet in need of special attention due to food sampling demonstrations, hair, wood, metal shavings, grease or paint.

RATES	
DISCOUNT PRICE	REGULAR PRICE
\$0.38 / sq.ft.	\$0.53 / sq.ft.

RATES		
BOOTH SQUARE FOOT	DISCOUNT PRICE	REGULAR PRICE
50 - 600 sq.ft.	\$0.55/sq.ft.	\$0.77/sq.ft.
601-1000 sq.ft.	\$0.45/sq.ft.	\$0.63/sq.ft.
OVER 1000sq.ft.	\$0.38/sq.ft.	\$0.53/sq.ft.

RATES	
DISCOUNT PRICE	REGULAR PRICE
To Be Quoted	N/A

SELECT SERVICE REQUIRED: Initial Cleaning Daily Cleaning Additional Services

_____ @ _____ = _____
Total sq.ft.of Booth \$ Per sq.ft. Total

Terms & Conditions

- All orders received after the Discount Price Date will be processed at the Regular Price.
- No cancellations after move-in begins.
- All claims or discrepancies must be settled at the GES Service Centre prior to show closing.
- All orders are governed by GES Limits of Liability and Responsibility

SUBTOTAL	
5% GST	
TOTAL	
GST #R104060264	

I have read and understand the Terms & Conditions of my Agreement with GES.

_____ _____
Signature Date

#3030 - 2600 Portland St. SE Calgary, Alberta, T2G 4M6 Tel: (403) 243-2212 Fax: (403) 243-3868 Toll Free 1-800-636-8235 www.gesexpo.ca

SHOW: Canadian Imaging Conference & Tradeshow	DISCOUNT PRICE DEADLINE DATE: March 25, 2016				
EXHIBITOR INFORMATION	CREDIT CARD AUTHORIZATION				
BOOTH #: _____	<input type="checkbox"/> MASTERCARD <input type="checkbox"/> VISA <input type="checkbox"/> AMEX <table border="1" style="width:100%; height: 20px; border-collapse: collapse;"> <tr> <td style="width: 25%;"> </td> <td style="width: 25%;"> </td> <td style="width: 25%;"> </td> <td style="width: 25%;"> </td> </tr> </table>				
COMPANY _____	EXPIRY DATE _____ / _____				
STREET _____	CARDHOLDER NAME _____				
CITY _____ PROV/STATE _____ CODE _____	CARDHOLDER SIGNATURE _____				
E-MAIL _____	<input type="checkbox"/> CHEQUE ATTACHED (PAYABLE TO GES)				
PHONE _____ FAX _____					
CONTACT NAME _____					

Show Special

→ Spend less
→ Sell More
→ Look great

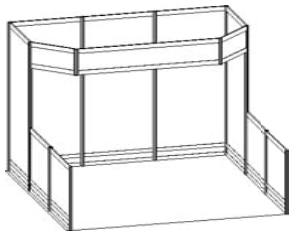

\$955.00

PACKAGE A: 10'x10' BOOTH

- Header Sign - 12"x78"
- Infill Panels
- Colour Coordinated 10'x10' Carpet
- Price after Deadline Date: **\$1,335.00**

- ✓ Installed and Dismantled
- ✓ Ready before you arrive
- ✓ No Labour Costs
- ✓ No Trucking Costs
- ✓ No Material Handling Costs
- ✓ Includes Carpet
- ✓ Includes Header Sign(s)
- ✓ Choice of Colours
- ✓ Accessories Available

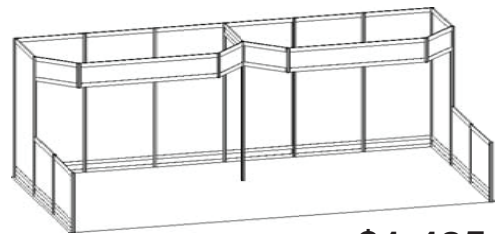

\$1,485.00

PACKAGE B: 10'x20' BOOTH

- 2 Header Signs - 12"x78" each
- Infill Panels
- Colour Coordinated 10'x20' Carpet
- Price after Deadline Date: **\$2,080.00**

Indicate Date and Time you plan to arrive to merchandise your exhibit: _____
Date Time

PLEASE COMPLETE THE FOLLOWING:	
SIZE ORDERED:	PACKAGE A: <input type="checkbox"/> 10'x10' PACKAGE B: <input type="checkbox"/> 10'x20'
Infill Panel Colour: White Only	
Carpet Colour: <input type="checkbox"/> Black <input type="checkbox"/> Blue <input type="checkbox"/> Red <input type="checkbox"/> Grey	
<i>(All panel & carpet colours subject to availability.)</i>	
Package A Identification Sign to Read: _____	
Package B Identification Sign to Read: Left: _____ Right: _____	
<input type="checkbox"/> Custom Header to be added	
Please e-mail artwork to: calgarygraphics@ges.com Label e-mail with Exhibitor Name & Show Name/Date (file must be eps, ai, cdr)	
Custom Header Signs/Logos will be charged \$100.00 extra per sign	
ALL ORDERS MUST BE PREPAID IN FULL	
(ORDERS CAN NOT BE PROCESSED UNTIL PAYMENT IS RECEIVED)	

Terms & Conditions

- Does not include lighting or electrical service.
- No refunds/exchanges once show move-in begins.
- All claims or discrepancies must be settled prior to show closing.
- All orders received after the Discount Price Date will be processed at the Regular Price.
- GES is not responsible for exhibit materials left in GEM rental exhibits or counter storage units.

I have read and understand the Terms & Conditions of my Agreement with GES.

SUBTOTAL	
5% GST	
TOTAL	
	GST #R104060264

Signature

Date



standard exhibit rentals

10' X 10'
EXHIBITS

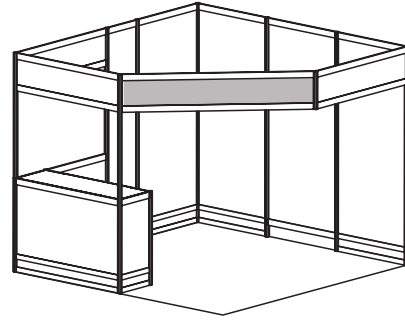

● GEM Model #1 - 10'x10' Corner

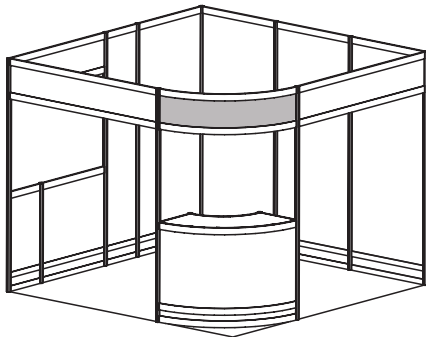

● GEM Model #2 - 10'x10' Corner

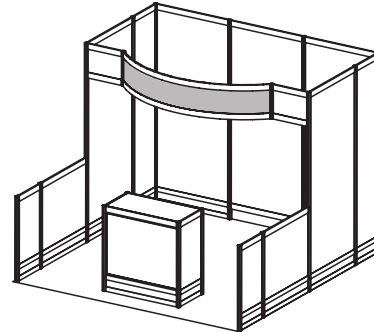

● GEM Model #3 - 10'x10'

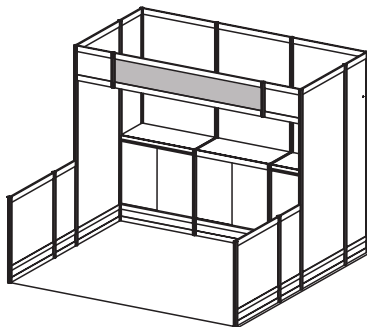

● GEM Model #4 - 10'x10'

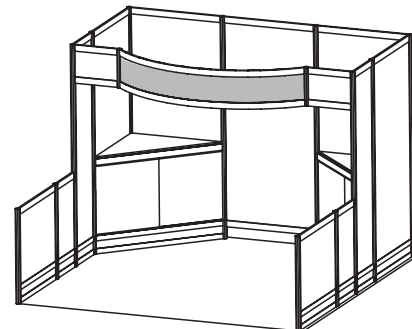

● GEM Model #5 - 10'x10'

3 Easy Steps →

- 1 Select the model number that suits your needs
- 2 Choose carpet and panel colours on the GEM Exhibit Rental order form
- 3 Complete & send order form

Grey indicates standard header sign(s)



standard exhibit rentals

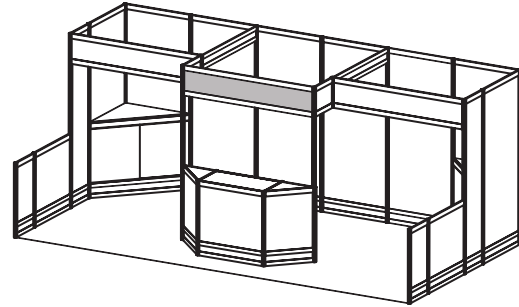

● GEM Model #6 - 10'x20'

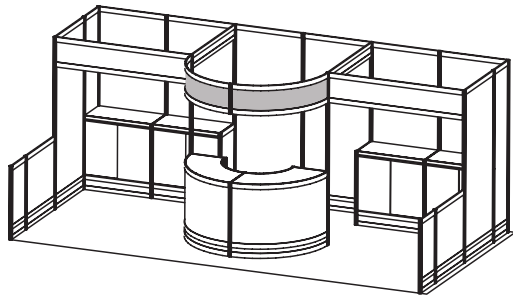

● GEM Model #7 - 10'x20'

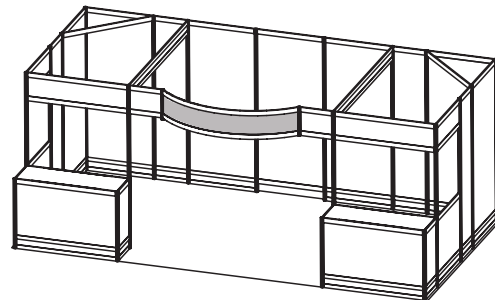

● GEM Model #8 - 10'x20'

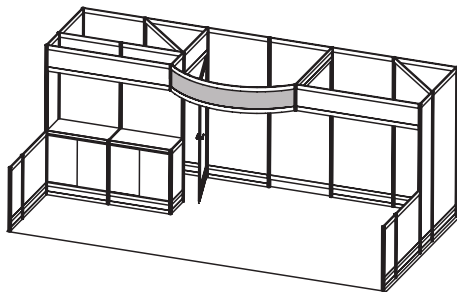

● GEM Model #9 - 10'x20'

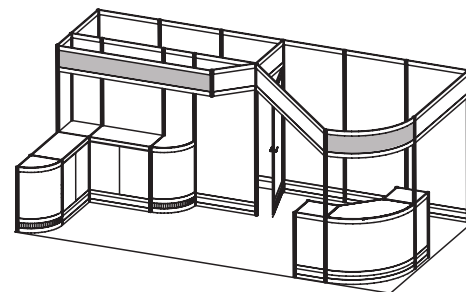

● GEM Model #10 - 10'x20' Corner

3 Easy Steps →

- 1 Select the model number that suits your needs
- 2 Choose carpet and panel colours on the GEM Exhibit Rental order form
- 3 Complete & send order form

Grey indicates standard header sign(s)

GEM EXHIBIT SYSTEM ORDER FORM

#3030 - 2600 Portland St. SE Calgary, Alberta, T2G 4M6 Tel: (403) 243-2212 Fax: (403) 243-3868 Toll Free 1-800-636-8235 www.gesexpo.ca

SHOW: Canadian Imaging Conference & Tradeshow

EXHIBITOR INFORMATION

BOOTH #: _____

COMPANY _____

STREET _____

CITY _____ PROV/STATE _____ CODE _____

E-MAIL _____

PHONE _____ FAX _____

CONTACT NAME _____

DISCOUNT PRICE DEADLINE DATE: March 25, 2016

CREDIT CARD AUTHORIZATION

MASTERCARD
 VISA
 AMEX

--	--	--	--	--	--	--	--

EXPIRY DATE ____ / ____

CARDHOLDER NAME _____

CARDHOLDER SIGNATURE _____

CHEQUE ATTACHED (PAYABLE TO GES)

**ALL ORDERS MUST BE PREPAID IN FULL
(ORDERS CANNOT BE PROCESSED UNTIL PAYMENT IS RECEIVED)**

Model Number	Discount Price	Regular Price	Model Number	Discount Price	Regular Price
Model #1	\$1,125.00	\$1,575.00	Model #6	\$2,235.00	\$3,130.00
Model #2	\$1,210.00	\$1,695.00	Model #7	\$2,860.00	\$4,000.00
Model #3	\$1,295.00	\$1,810.00	Model #8	\$2,340.00	\$3,275.00
Model #4	\$1,540.00	\$2,155.00	Model #9	\$2,645.00	\$3,700.00
Model #5	\$1,645.00	\$2,300.00	Model #10	\$3,210.00	\$4,495.00

Package Includes: Installation & Dismantling, Choice of Carpet Colour, Choice of Panel Colour, Company Identification Sign

Package Does Not Include: Cleaning, Light Fixtures or Electrical Outlets

PLEASE COMPLETE THE FOLLOWING: MODEL NUMBER: *Upgrade options available. Contact Exhibitor Services.*

Font Colour: Black

Infill Panel Colour: Black Blue Grey White

Carpet Colour: Black Blue Grey Red *(All panel & carpet colours subject to availability.)*

Models 1, 2, 3, 4, 5, 6, 8 or 9 Identification Sign to Read: _____

Models 7 or 10 Identification Sign to Read: Left: _____ Right: _____

Indicate Date & Time for Arrival: _____

Custom Header Signs/Logos will be charged \$100.00 extra per sign

**ALL ORDERS MUST BE PREPAID IN FULL
(ORDERS CANNOT BE PROCESSED UNTIL PAYMENT IS RECEIVED)**

Terms & Conditions

- Payment may be made by cheque up to two weeks prior to the 1st day of move in.
- All orders received after the Discount Price Date will be processed at the Regular Price.
- Exhibitor is responsible for all items for the duration of the show.
- Charges are for rental of equipment only. All items remain the property of GES.
- No refunds/exchanges once show move-in begins. All claims or discrepancies must be settled prior to show closing.
- GES is not responsible for exhibit materials left in GEM rental exhibits or counter storage units.

SUBTOTAL	
5% GST	
TOTAL	
	GST #R104060264

I have read and understand the Terms & Conditions of my Agreement with GES.

Signature

Date

#3030 - 2600 Portland St. SE Calgary, Alberta, T2G 4M6 Tel: (403) 243-2212 Fax: (403) 243-3868 Toll Free 1-800-636-8235 www.gesexpo.ca

SHOW: Canadian Imaging Conference & Tradeshow

EXHIBITOR INFORMATION

BOOTH #: _____

COMPANY _____

STREET _____

CITY _____ PROV/STATE _____ CODE _____

E-MAIL _____

PHONE _____ FAX _____

CONTACT NAME _____

DISCOUNT PRICE DEADLINE DATE: March 25, 2016

CREDIT CARD AUTHORIZATION

MASTERCARD VISA AMEX

_____|_____|_____|_____|_____|_____|_____|_____|

EXPIRY DATE ____/____/____

CARDHOLDER NAME _____

CARDHOLDER SIGNATURE _____

CHEQUE ATTACHED (PAYABLE TO GES)

ALL ORDERS MUST BE PREPAID IN FULL
(ORDERS CAN NOT BE PROCESSED UNTIL PAYMENT IS RECEIVED) LIGHTS ARE INCLUDED IN SHOWCASES (ELECTRICAL SERVICES EXTRA)

QTY	#	DESCRIPTION	DISCOUNT PRICE	REGULAR PRICE	TOTAL
	1	Pedestal (White) 20"L x 20"W □ 28"H or □ 36"H	\$87.00	\$122.00	
	2	Pedestal White 40"L X 40"W (Tops are 20" X 20") (Unit Heights - 16"- 28" & 28"- 40")	\$436.00	\$610.00	
	3	Storage Counter (White) 80"L X 20"W X 40"H	\$260.00	\$364.00	
	4	Curved Counter (White) 60"L X 20"W X 36"H	\$178.00	\$249.00	
	5	99A Showcase (White/Glass) 40"L X 20"W X 40"H	\$178.00	\$249.00	
	6	99B Showcase (White/Glass) 40"L X 20"W X 40"H	\$181.00	\$253.00	
	7	99C Showcase (White/Glass) 26"L X 26"W X 96"H	\$263.00	\$368.00	
	8	99D Showcase (White/Glass) 40"L X 20"W X 96"H	\$371.00	\$519.00	

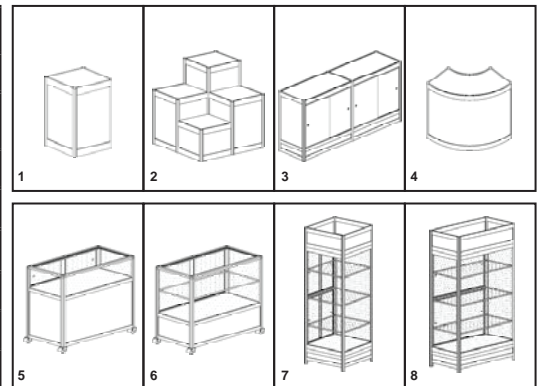

QTY	#	DESCRIPTION	DISCOUNT PRICE	REGULAR PRICE	TOTAL
	A	Waterfall With Eight Balls	\$17.00	\$24.00	
	C	Garmet Rail 39"W	\$44.00	\$61.00	
	D	Shelves □ Flat □ Angled 37"L X 12"W	\$37.00	\$52.00	
	E	Slatwall Panels - 37"W X 96"H Grey (Upgrade for standard panels)	\$102.00	\$143.00	

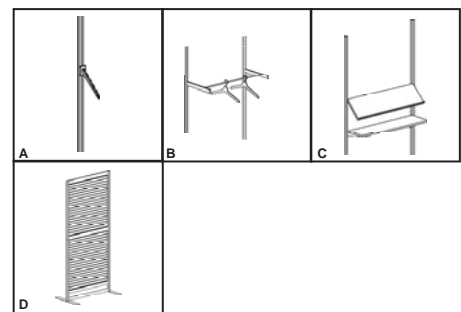

To Be Able To Rent These Accessories, You Must Order a GEM Hardwall Booth From GES

Please Attach Diagram Of Booth Indicating Locations For Grid Panels And/Or Slatwall. Grid Panels Cannot Be Installed In Corners.

Terms & Conditions

- All items subject to availability.
- No refunds/exchanges once show move-in begins.
- All claims or discrepancies must be settled prior to show closing.
- Exhibitor is responsible for all items for the duration of the show.
- Charges are for rental of equipment. All items remain the property of GES.
- All orders received after the Discount Price Date will be processed at the Regular Price.

SUBTOTAL	_____
5% GST	_____
TOTAL	_____
	GST #R104060264

I have read and understand the Terms & Conditions of my Agreement with GES.

Signature

Date

SIGN ORDER FORM

#3030 - 2600 Portland St. SE Calgary, Alberta, T2G 4M6 Tel: (403) 243-2212 Fax: (403) 243-3868 Toll Free 1-800-636-8235 www.gesexpo.ca

SHOW: Canadian Imaging Conference & Tradeshow

DISCOUNT PRICE DEADLINE DATE: March 25, 2016

EXHIBITOR INFORMATION

BOOTH #: _____

COMPANY _____

STREET _____

CITY _____ PROV/STATE _____ CODE _____

E-MAIL _____

PHONE _____ FAX _____

CONTACT NAME _____

CREDIT CARD AUTHORIZATION

MASTERCARD VISA AMEX

--	--	--	--	--	--	--	--	--	--

EXPIRY DATE ____ / ____

CARDHOLDER NAME _____

CARDHOLDER SIGNATURE _____

CHEQUE ATTACHED (PAYABLE TO GES)

ALL ORDERS MUST BE PREPAID IN FULL (ORDERS CAN NOT BE PROCESSED UNTIL PAYMENT IS RECEIVED)

SIGN LAYOUT

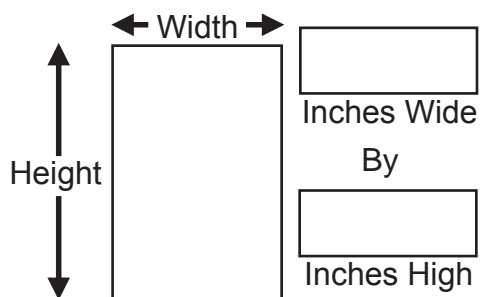

Sign Sizes	Discount Price	Regular Price
11" x 14"	\$ 41.00	\$ 57.00
14" x 22"	\$ 57.00	\$ 80.00
22" x 28"	\$ 89.00	\$125.00
7" x 44"	\$ 57.00	\$ 80.00
28" x 44"	\$153.00	\$214.00
40" x 60"	\$233.00	\$326.00

LOGOS ARE NOT INCLUDED IN PRICING

PLEASE PRINT OR TYPE WORDING REQUIRED:

ALL SIGNS MUST BE PICKED UP FROM OUR ON-SITE SERVICE DESK.

Terms & Conditions

- All orders received after the Discount Price Date will be processed at the Regular Price.
- There are no refunds/exchanges on signs.
- All claims or discrepancies must be settled at the GES Service Centre prior to show closing.

SUBTOTAL	
5% GST	
TOTAL	
GST #R104060264	

I have read and understand the Terms & Conditions of my Agreement with GES.

Signature

Date

#3030 - 2600 Portland St. SE Calgary, Alberta, T2G 4M6 Tel: (403) 243-2212 Fax: (403) 243-3868 Toll Free 1-800-636-8235 www.gesexpo.ca

SHOW: Canadian Imaging Conference & Tradeshow

EXHIBITOR INFORMATION

BOOTH #: _____

COMPANY _____

STREET _____

CITY _____ PROV/STATE _____ CODE _____

E-MAIL _____

PHONE _____ FAX _____

CONTACT NAME _____

DISCOUNT PRICE DEADLINE DATE: March 25, 2016

CREDIT CARD AUTHORIZATION

MASTERCARD VISA AMEX

--	--	--	--	--	--	--	--	--	--

EXPIRY DATE _____ / _____

CARDHOLDER NAME _____

CARDHOLDER SIGNATURE _____

CHEQUE ATTACHED (PAYABLE TO GES)

PRICE LIST

Quantity	Item #	Description	Discount Price	Regular Price	Total Price
Electrical - 110 Volt					
	EL1500W	1500 Watt Duplex Outlet	\$ 73.00	\$ 102.00	
	EL2000W	2000 Watt Duplex Outlet (available upon request)			
Electrical - 220 Volt - Single Phase					
	EL MISC	220 V / 20 Amp Single Phase	\$ 164.00	\$ 230.00	
	ELMISC	220 V / 30 Amp Single Phase	\$ 196.00	\$ 275.00	
	ELMISC	220 V / 50 Amp Single Phase	\$ 245.00	\$ 343.00	
Lighting (Does Not Include Power)					
	ELD150F	Flood Light Stand, 2 - 75 Watt Flood Bulbs	\$ 65.00	\$ 91.00	
	ELQL	500 Watt Quartz Light	\$ 83.00	\$ 116.00	
	ELMISC	Special Hookups & Specialty Lighting Available upon request			

Please Note the Following:

- 24 Hour power - add 50% to the above prices Outside power - add 100 % to the above prices
- Electrician Charge Extra, If Required Additional labour charges may apply for special connections or special wiring

Payment & Credit Card Charge Authorization form MUST Accompany this form

Notes	TOTAL OF ALL ITEMS ORDERED 5% GST PAYMENT ENCLOSED
-------	---

All orders governed by the GES payment policy & GES Terms & Conditions of Contract as specified in this Exhibitor's Kit.
 Cancellation Policy: Orders cancelled will be charged 50% of original price after move-in and 100% of original price after installation.

Company Name:	Email Address:	Booth #
Authorized Signature	Authorized Contact	Date

LABOUR SERVICE ORDER FORM

#3030 - 2600 Portland St. SE Calgary, Alberta, T2G 4M6 Tel: (403) 243-2212 Fax: (403) 243-3868 Toll Free 1-800-636-8235 www.gesexpo.ca

SHOW: Canadian Imaging Conference & Tradeshow

EXHIBITOR INFORMATION

BOOTH #: _____

COMPANY _____

STREET _____

CITY _____ PROV/STATE _____ CODE _____

E-MAIL _____

PHONE _____ FAX _____

CONTACT NAME _____

DISCOUNT PRICE DEADLINE DATE: March 25, 2016

CREDIT CARD AUTHORIZATION

MASTERCARD
 VISA
 AMEX

--	--	--	--	--	--	--	--

EXPIRY DATE _____ / _____

CARDHOLDER NAME _____

CARDHOLDER SIGNATURE _____

CHEQUE ATTACHED (PAYABLE TO GES)

CREDIT CARD AUTHORIZATION (ABOVE) MUST BE COMPLETED AS METHOD OF PAYMENT FOR THIS SERVICE

LABOUR RATES ARE CHARGED PER PERSON AT **A MINIMUM CHARGE OF ONE HOUR**. LABOUR OVER ONE HOUR IS CHARGED IN 1/2 HOUR INCREMENTS. (A 30% SURCHARGE WILL BE APPLIED TO ON-SITE ORDERS)

Straight Time 8:00am - 4:00pm Monday - Friday \$ 69.00 PER HOUR	Overtime After 4:00pm Weekdays & All Day Sat, Sun and holidays \$103.50 PER HOUR
--	---

EXHIBITOR MUST REPORT TO GES SERVICE CENTRE TO RECEIVE THEIR LABOUR

INSTALLATION Set Up Drawings or Photos Attached: yes no

Carrier: _____ Delivery Date: _____ Delivery Time: _____ am pm
Day / Date/ Month / Year

SUPERVISION By Exhibitor (Provide Name of Rep): _____ By GES 30% surcharge applies
(Exhibitor MUST be Present to Supervise) (Exhibitor does NOT have to be present)

DATE LABOUR REQUIRED: _____ START TIME REQUIRED: _____ am pm
Day / Date/ Month / Year

NUMBER OF PEOPLE REQUIRED X HOURS PER PERSON = TOTAL HOURS

DISMANTLING

Carrier: _____ Pick-up Date: _____ Pick-up Time: _____ am pm
Day / Date/ Month / Year

SUPERVISION By Exhibitor (Provide Name of Rep): _____ By GES 30% surcharge applies
(Exhibitor MUST be Present to Supervise) (Exhibitor does NOT have to be present)

DATE LABOUR REQUIRED: _____ START TIME REQUIRED: _____ am pm
Day / Date/ Month / Year

NUMBER OF PEOPLE REQUIRED X HOURS PER PERSON = TOTAL HOURS

- Terms & Conditions**
- When Exhibitor is supervising labour the Exhibitor must check labour in and out at the GES Service Centre.
 - We reserve the right to change labourers and/or rates as shifts change.
 - All claims or discrepancies must be settled within one week of show closing.
 - Uncancelled labour will be charged a minimum fee of 1 hour per person.
 - GES Limits of Liability apply.

I have read and understand the Terms & Conditions of my Agreement with GES.

_____ _____ GST #R104060264
Signature **Date**



MATERIAL HANDLING ORDER FORM

#3030 - 2600 Portland St. SE Calgary, Alberta, T2G 4M6 Tel: (403) 243-2212 Fax: (403) 243-3868 Toll Free 1-800-636-8235 www.gesexpo.ca

SHOW: Canadian Imaging Conference & Tradeshow

DISCOUNT PRICE DEADLINE DATE: March 25, 2016

EXHIBITOR INFORMATION

BOOTH #: _____

COMPANY _____

STREET _____

CITY _____ PROV/STATE _____ CODE _____

E-MAIL _____

PHONE _____ FAX _____

CONTACT NAME _____

CREDIT CARD AUTHORIZATION

MASTERCARD VISA AMEX

--	--	--	--	--	--	--	--	--	--	--	--

EXPIRY DATE _____ / _____

CARDHOLDER NAME _____

CARDHOLDER SIGNATURE _____

CHEQUE ATTACHED (PAYABLE TO GES CANADA)

CREDIT CARD AUTHORIZATION (ABOVE) MUST BE COMPLETED AS METHOD OF PAYMENT FOR THIS SERVICE

ADVANCE SHIPMENT(S) TO WAREHOUSE:

- Shipment(s) must be received by: _____
- Estimated Weight of Shipment(s) - Rounded up to the nearest 100lbs:
- Rate **\$60.00** per 100lbs. (200lb. minimum) **Pounds**
- Shipment(s) received after _____ will be charged at the direct shipment rate.

DIRECT SHIPMENT(S) TO SHOWSITE:

- Shipment(s) may arrive at Show Site on or after: _____
- Estimated Weight of Shipment(s) - Rounded up to the nearest 100lbs:
- Rate **\$47.00** per 100lbs. (200lb. minimum) **Pounds**
- Shipments arriving without a certified weight ticket will be subject to Special Handling rates.

SMALL PACKAGES: (Maximum 50lbs / Shipment):

- Rate of **\$39.00** First Package
- Rate of **\$10.00** for each additional package (in the same shipment) to a 50lb. Maximum
- **If over 50lbs., Rates for Advance or Direct Shipments will apply**

SPECIAL HANDLING: (30% Surcharge Applies to Entire Shipment):

- Shipments of loose, padded or uncrated materials. Special unloading requirements, such as ground side door/ constricted or stacked unloading.
- Shipments without certified weight ticket or proven inaccurate weight ticket.

PLEASE COMPLETE THE FOLLOWING:

Carrier Name: _____ Number of Pieces: _____ Total Weight: _____

Goods are scheduled for delivery to: Show Site Advance Warehouse

Date goods are scheduled to arrive: _____ Month/Day

Terms & Conditions

- Collect shipments will not be accepted.
- GES is not responsible for concealed damage, damage to loose or inadequately packed shipments or loss of merchandise after delivery to booth.
- It is the exhibitor's responsibility to secure and maintain loss & damage insurance coverage for their exhibit properties.
- All claims or discrepancies must be settled at the GES Service Centre prior to show closing.

SUBTOTAL	
5% GST	
TOTAL	
<small>GST #R104060264</small>	

I have read and understand the Terms & Conditions of my Agreement with GES.

Signature

Date

ADVANCE WAREHOUSE *SHIPPING LABEL*

EXHIBIT SHIPMENT FOR ADVANCE WAREHOUSE

SHIPPER: _____
(Name of Company where shipment originates.)

TO: _____
(Name of your exhibiting Company at the show.)

BOOTH NUMBER: _____
(Your booth number at the show.)

C/O: GES / Canadian Imaging Conference & Tradeshow
#3030-2600 Portland St. SE
Calgary, Alberta, Canada
T2G 4M6

CARRIER: _____
(Name of your Transportation Company)

NUMBER **OF** **PIECES**

ADVANCE WAREHOUSE SHIPMENTS SHOULD ARRIVE BEFORE:

APRIL 13, 2016

1. GES CANADA Exposition Services herein known as GES and its subcontractors shall not be responsible for damage to uncrated materials; materials improperly packed, glass breakage or concealed damage.

2. Relative to inbound shipments, there may be a lapse of time between the delivery of shipment(s) to the booth by GES or its subcontractors and the arrival of the Exhibitor's representative at the booth. Similarly, relative to outgoing shipment(s), it is possible that there will be a lapse of time between the completion of packing and the actual pick-up of materials from the booth for loading onto a carrier. It is understood that during such times the shipment(s) will be left in the booth unattended.

Therefore, it is agreed that GES and its subcontractors are not responsible for the loss or disappearance of Exhibitor's materials after the same have been delivered to Exhibitor's booth, nor are GES and its subcontractors responsible for Exhibitor's materials before they are picked up from the Exhibitor's booth for loading after the show. Consequently, all bills of lading covering outgoing shipment(s) submitted to GES or its subcontractors by Exhibitor will be checked at the time of pick-up from the booth and corrected where discrepancies exist.

3. GES and its subcontractors shall not be held liable for any damage incurred during the handling of equipment requiring special devices to properly load, place or reload unless advance notice has been given to GES in time to obtain the proper equipment.

4. GES and its subcontractors shall not be responsible for loss, delay or damage due to strikes, lockouts or work stoppages of any kind.

5. GES and its subcontractors shall not be responsible for ordinary wear and tear in handling of equipment, nor for loss or damage due to fire, theft, windstorm, water, vandalism, acts of God, mysterious disappearance or other causes beyond their control.

6. It is understood that GES and its subcontractors are not insurers. Insurance, if any, shall be obtained by the Exhibitor. Amounts payable to GES hereunder are based on the scope of the liability as herein set forth and are unrelated to the value of the Exhibitor's property. It is further understood and agreed that GES and its subcontractors do not provide for full liability should loss or damage occur. It is agreed that if GES or its subcontractors should be found liable for loss or damage to Exhibitor's equipment, the liability shall be limited to the specific article that was physically lost or damaged. Such liability shall be limited to a sum equal to \$0.30 per pound per article, with a maximum liability of \$50.00 per item or \$1,000.00 per shipment, whichever is less, as agreed upon damages and exclusive remedy. Provisions of this paragraph shall apply if loss or damage, regardless of cause or origin, results directly or indirectly to property through performance services to

Exhibitor's or from negligence, active or otherwise, by GES, its subcontractors or their employees.

7. GES and its subcontractors shall not be liable to any extent whatsoever for any actual, potential or assumed loss of profits or revenues or for any collateral costs that may result from any loss or damage to Exhibitor's materials which may make it impossible or impracticable to exhibit same.

8. Claims for loss or damage must be submitted to GES by the close of the show. No suit or action shall be brought against GES or its subcontractors more than one year after the cause of action.

9. The Exhibitor agrees, in connection with the receipt, handling, temporary storage and reloading of its materials, that GES and its subcontractors will provide these services as Exhibitor's agent and not as bailee or shipper. If any employee of GES or its subcontractors shall sign a delivery receipt, bill of lading or other document, we agree that GES or its subcontractor will do so as the Exhibitor's agent, and the Exhibitor accepts the responsibility thereof.

10. GES and its subcontractors shall not be liable for shipments received without receipts, freight bills or specified unit counts on receipts or freight bills, such as a courier or van lines. Such shipments will be delivered to booth without guarantee of piece count or condition.

11. Empty container labels will be available at the GES Service Centre. Affixing the labels is the sole responsibility of the Exhibitor or its representative. It is understood that these labels are used for EMPTY STORAGE ONLY, and GES and its subcontractors assume no responsibility for loss or damage to contents while containers are in storage or for mislabelled containers.

12. In order to expedite removal of materials from the show site, GES shall have the authority to change designated carriers, if such carriers do not pick up on time. Where no disposition is made by the Exhibitor, materials will be taken to a warehouse to await Exhibitor's shipping instructions, and the Exhibitor agrees to be responsible for payment of charges relating to such handling at the warehouse. GES assumes no liability as a result of such re-routing or handling.

13. The Exhibitor agrees, in the event of a dispute with GES or its subcontractors relative to any loss or damage to any of your materials or equipment, that the Exhibitor will not withhold payment in any amount due to GES for material handling services or any other services provided by GES or its subcontractors as an offset against the amount of the alleged loss or damage. Instead, the Exhibitor agrees to pay GES prior to the close of the show for all such charges and further agrees that any claim the Exhibitor may have against GES or its subcontractors shall be pursued independently by the Exhibitor as a completely separate transaction to be resolved on its own merits.

The consignment or delivery of a shipment to GES or its subcontractors by an Exhibitor or by any shipper on behalf of the Exhibitor shall be construed as an acceptance by such Exhibitor (and/or other shipper) of the terms and conditions set forth in Sections 1 through 13 above.

Be sure your materials are insured from the time they leave your firm until they are returned after the show. It is suggested that Exhibitors arrange all risk coverage. This can usually be done by riders to existing policies. Contact your insurance representative. Be sure your liability insurance is in effect during transit and return of your materials, during storage and at show site.



logistics

GES is proud to offer our clients a one source solution for Transportation services

GES Logistics Services

Your Choice of Reliable Service Options

- Time Critical Ground
- Expedited Ground
- 3-5 Day Deferred
- Common Carrier
- Van Line

24-Hour Tracking

Call toll free 1-800-636-8235 for immediate information on the status of your shipment

On-Site Representation

GES Logistics representatives will be on site from the beginning of move-in and throughout the event until the last shipment leaves the show floor

Competitive Pricing

You will benefit from priority delivery at competitive prices thanks to special arrangements we have with select carriers

Simplified Budgeting

Our transportation management system gives you the information you need to budget more effectively

Simplified Ordering

For your convenience choose one of the ordering options available:

- Online: www.gesexpo.ca
- Phone: 403-243-2212 or 1-800-636-8235
- Fax: 403-243-3868

Ship everywhere with GES Logistics Services.



#3030 - 2600 Portland St. SE Calgary, Alberta, T2G 4M6 Tel: (403) 243-2212 Fax: (403) 243-3868 Toll Free 1-800-636-8235 www.gesexpo.ca

PICK UP INFORMATION

COMPANY NAME: _____ PICK UP DATE: _____ PICK UP TIME: _____
 ADDRESS: _____ BUSINESS HOURS: _____ LOADING DOCK: YES NO
 CITY: _____ PROV/STATE: _____ CODE: _____ CUSTOMS PAPERWORK ATTACHED: YES NO
 CONTACT: _____ IF YES, CUSTOMS BROKER: _____
 PHONE: _____ CONTACT: _____
 FAX: _____ EMAIL: _____ PHONE: _____

I will be shipping to: ADVANCED WAREHOUSE SHOW SITE

DESTINATION

COMPANY NAME: _____ BOOTH #: _____
 ON-SITE CONTACT: _____
 SHOW NAME: _____ DELIVERY DATE: _____ DELIVERY TIME: _____
 FACILITY: _____
 ADDRESS: _____
 CITY: _____ PROV/STATE: _____ CODE: _____

SERVICE REQUIRED

ONE WAY ROUND TRIP
 SAME DAY OVERNIGHT 2ND DAY 3-5 DAY GROUND

ITEMS TO BE SHIPPED

SERVICE WILL BE CHARGED ON **ACTUAL** WEIGHT & DIMENSIONS

TOTAL NUMBER OF PIECES:	DIMENSIONS IN INCHES:	ESTIMATED WEIGHT:
_____ CARTONS (CARDBOARD)	H _____ x W _____ x L _____	
_____ CASES/TRUNKS (FIBRE) COLOUR: _____	H _____ x W _____ x L _____	
_____ CRATES (WOODEN)	H _____ x W _____ x L _____	
_____ SKIDS/PALLETS	H _____ x W _____ x L _____	
_____ CARPET/COLOUR: _____	H _____ x W _____ x L _____	
_____ OTHER LIST: _____	H _____ x W _____ x L _____	
_____ TOTAL	TOTAL WEIGHT:	

BILLING AND PAYMENT INFORMATION

COMPANY NAME: _____ ADDRESS: _____ CITY: _____
 PROV/STATE: _____ CODE: _____ EMAIL: _____ TEL: _____ FAX: _____
 CREDIT CARD NUMBER: _____ EXPIRY DATE: _____
 VISA MASTERCARD AMERICAN EXPRESS
 CARDHOLDER NAME: _____ CARDHOLDER SIGNATURE: _____

TERMS & CONDITIONS

GES assumes no responsibility for shipments left in booth by exhibitor. All materials are subject to final count and correction at time of actual removal from booth. Shipper hereby designates GES as its agent for tendering shipments to carrier. GES reserves the right to reroute any outgoing shipment via an alternate carrier in the event the requested carrier fails to pick up the shipment by established carrier check-in deadline. GES assumes no responsibility for misdirected shipments as a result of old shipping labels which remain on containers. It is the shipper's responsibility to state the national motor freight classification commodity description, otherwise shipment shall be described as exhibition materials.

1) GES shall not be responsible for damage to uncrated materials, materials improperly packed, or concealed damage. 2) GES shall not be responsible for loss, theft, or disappearance of exhibitors material after same has been delivered to exhibitor's booth. 3) GES shall not be responsible for loss, theft, or disappearance of materials before they are picked up from exhibitor's booth for reloading after the show. Bill of Lading covering outgoing shipments, which are furnished by GES CANADA to exhibitors, will be checked at time of actual pick-up from booth and corrections made where discrepancies occur. 4) GES shall not be responsible for any loss, damage, or delay due to fire, acts of God, strikes, lockouts or work stoppages of any kind, or to any causes beyond its control. 5) GES's liability shall be limited to the physical loss or damage to the specific article which is lost or damaged, and in any event GES's maximum liability shall be limited to \$0.30 per pound per article with a maximum liability of \$50.00 per item, or \$1,000.00 per shipment, whichever is less. 6) GES shall not be liable to any extent whatsoever for any actual, potential, or assumed losses of profits or revenues, or for any collateral costs, which may result from any loss or damage to an exhibitor's materials which may make it impossible or impractical to exhibit same. 7) The consignment or delivery of a shipment to GES by an exhibitor, or by any shipper to or on behalf of the exhibitor, shall be construed as an acceptance by such exhibitor (and/or other shipper) of the terms and conditions set forth. Exhibitor is responsible to declare all hazardous materials and abide by all federal, state and local laws.

By signing this order form, shipper agrees to be bound by all its terms and conditions.

X _____ Date: _____

Please Print Name: _____



customs

GES is proud to offer our clients a one source solution for Customs and Transportation services

GES Customs Services

Reliable and Efficient Service

- Experienced and reliable staff you can depend on who specialize in Tradeshow Customs procedures
- Personnel are accessible at all times

Value Added Service

- Save time and money by making fewer calls

Personalized Service

- Telephone, email and fax communication
- Forms and instructions for completion in all Exhibitor Service Kits
- One-on-one Customs consultation to assist all exhibitors with their specific needs

On-Site Representation

GES Customs Services representatives will be on site from the beginning of move-in and throughout the event until the last shipment leaves the tradeshow floor

Simplified Ordering

For your convenience choose one of the ordering options available:

- Online: www.gesexpo.ca
- Phone: 403-243-2212 or 1-800-636-8235
- Fax: 403-243-3868

Leave all your shipping, customs clearance and furniture rentals to GES.



Table of Contents

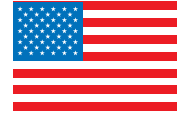

Please Read Carefully Before Completing the Attached Documents

CANADA CUSTOMS DOCUMENTATION REQUIRED	Page 1
US CUSTOMS DOCUMENTATION REQUIRED	Page 1
DETAILED DESCRIPTION & INSTRUCTIONS	Pages 2 - 7

SAMPLES & ORDER FORMS

A) GES Customs/Transportation Order Form (Mandatory for all shipments)	Pages A-A1
B) CANADA CUSTOMS INVOICE (Mandatory for all shipments)	Pages B-B1
C) NAFTA CERTIFICATE OF ORIGIN	Pages C-C1
D) CERTIFICATE OF REGISTRATION (Form 4455)	Pages D-D1
E) FCC RADIO FREQUENCY FORM (Form 740)	Pages E-E1
F) RADIATION CONTROL FORM (Form FD 2877)	Pages F-F1
G) TEXTILE DECLARATION	Pages G1
H) PRIVATE VEHICLE SHIPMENT INFORMATION FORM	Pages H-H1

**ALL DOCUMENTS MUST BE FAXED TO GES CUSTOMS BROKERAGE
SERVICES PRIOR TO SHIPPING**

Telephone: (403) 243-2212 Fax: (403) 243-3868
e-mail: calgary@gesexpo.com website: www.gesexpo.ca

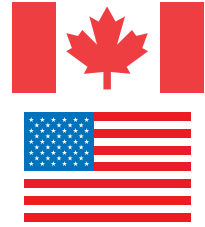

WELCOME TO CANADA

Canada is very proud to open its doors and borders to International Conventions, Meetings and Tradeshows. Like all countries, we have rules and regulations with respect to crossing the border and they are controlled and administered by Canada Customs, an official agency of the Revenue Department of the Canadian Government.

GES Customs Brokerage Services can help you make exhibiting across the border a simple and straightforward two-way experience for your people, products and display equipment. The following pages contain information and forms to assist you in that process by explaining what and when things have to be done.

CUSTOMS SIMPLIFIED - TIPS FOR SHIPPING ACROSS THE BORDER

- 1. ⇨ Use Official Suppliers**
It is beneficial for exhibitors to use the official suppliers selected for the show (i.e. GES Customs Brokerage Services and GES Logistics).
- 2. ⇨ Complete Customs Documents**
Complete all mandatory and necessary documents and fax copies to our GES office prior to shipping. Send all originals with the shipment and bring 2 copies to the show.
- 3. ⇨ Ship on Time**
Have materials shipped to arrive 7 days prior to move-in and consolidate shipments to reduce costs. GES Logistics is the recommended transportation carrier. **All shipments must be paid for in advance. We do not recommend shipping by parcel carriers or by mail.**
- 4. ⇨ Hand Carrying or Private Vehicle**
Notify GES in advance if you are bringing goods with you on the plane or crossing the border by company, rented or your own vehicle.
- 5. ⇨ Tracing Service**
To assist GES personnel in locating your exhibit freight please bring a record of the shipment "Tracking Number" provided by GES Logistics or your carrier. Our personnel have the knowledge and connections to expedite your shipment to the show site as quickly as possible.
- 6. ⇨ Changes & Return Shipments**
Notify GES Customs Brokers immediately of any change(s) to what is being shipped, quantities, addresses, etc., as well as what materials will be returned to the U.S. and provide the correct return address.
- 7. ⇨ Communicate with GES CUSTOMS/LOGISTICS Contacts**
GES will be in touch with you starting 3-4 weeks prior to the event and will have staff on site or on call during move-in, show days, and move-out. Exhibitors will be provided with cell phone numbers for 24-hour, 7-days-a-week access to your GES CUSTOMS and LOGISTICS contacts.

CANADA CUSTOMS DOCUMENTS:

(Explanations and direction to samples and order forms for completion)

TIP: Review and highlight the forms that apply to your shipments for completion

- GES Customs/Transportation Order Form – (Mandatory for all shipments)**
- gives GES the authority to clear and coordinate the movement of your materials on your behalf (Pages A - A1 Sample).
- Canada Customs Invoice – CCI – (Mandatory for all shipments)** - itemizes the contents of your shipment; quantities, countries of origin, unit and total shipment values. This is also where you would notify GES of any goods that will require special treatment or permits (Page B – B1 Sample).
- NAFTA Certificate of Origin** - Goods that will be distributed (giveaways) to a Canadian, or remain in Canada must be identified on this form in order to receive the most favourable duty & tax treatment. This applies to NAFTA countries only; USA, Canada and Mexico (Pages C – C1 Sample).
- Private Vehicle Shipment Information** – Goods that will be crossing the border via a company vehicle, rental or personal vehicle. You must fax GES this completed document one week in advance of your intended date of crossing. (Page H)
- Airline Hand Baggage** - In the event you intend on bringing exhibit materials or commercial goods with you as hand baggage, a formal customs clearance may be required. Contact GES prior to departure for further information. Failure to follow these instructions may result in unexpected delays or payments at the airport. (Note: No Form)

UNITED STATES CUSTOMS DOCUMENTS:

(Explanations and direction to samples and order forms for completion)

TIP: Review and highlight the forms that apply to your shipments for completion

- Certificate of Registration (FORM 4455)** -Goods that are not of USA origin and are intended to return to the USA (Pages D – D1 Sample).

ATTENTION ELECTRONIC SHIPPERS - MANDATORY

By not completing the following forms your materials will be denied re-entry into the USA

- Radio Frequency Form (FCC 740)** – Goods that emit radio frequencies, e.g. computers, video cameras/recorders is mandatory by order of the U.S. Federal Communication Commission (Pages E – E1 Sample)
- Radiation Form (FD 2877)** – Goods that emit radiation, e.g. CD Players, laser printers, monitors, televisions, x-ray equipment, etc. and is mandatory by order of U.S. Food & Drug Administration (Pages F – F1 Sample).

ATTENTION TEXTILE SHIPPERS - MANDATORY

By not completing the following forms your materials will be denied re-entry into the USA

- Textile Declaration** - Goods such as carpets, curtains and clothing require this declaration to re-enter the USA. (Pages G – G1 Sample).

ALL DOCUMENTS MUST BE FAXED TO GES CUSTOMS BROKERAGE SERVICES PRIOR TO SHIPPING

Telephone: (403) 243-2212

Fax: (403) 243-3868 e-mail: calgary@gesexpo.com

DETAILED DESCRIPTION & INSTRUCTIONS

☐ **GES Customs/Transportation Order Form**

This Order Form ***must be completed*** for all shipments.

The GES Customs Order Form is your authorization to allow GES to act on your behalf. GES cannot clear your goods through Canada Customs without this form being fully completed. The information completed on this form allows us to properly classify and process your shipment(s) into and out of Canada. It also provides payment authorization and IRS identification details for the safe return of your goods back to the USA. GES accepts Credit Card, Cheque, Bank Transfer or Money Order.

Charges for GES Customs Brokerage services include the posting of any Canada Customs Bonds that may be required plus any additional pay-outs that are made on your behalf. These amounts may include duty and taxes for goods that remain in Canada, local cartage fees, terminal fees and U.S. Customs clearance.

Action ☐ Please complete ***all*** areas of the Form and fax to GES.

☐ **Canada Customs Invoice – CCI**

This document ***must accompany*** every shipment.

The *Canada Customs Invoice – CCI*, is the most important document for any exhibition materials entering Canada. It must itemize all goods contained in the shipment with a description, quantity, value and country of origin.

- Action** ☐
1. Fill in all required information on the *Canada Customs Invoice – CCI*
 2. Include the original and two copies of your completed *Canada Customs Invoice*, in an envelope and staple to your Truck Bill of Lading or Air Waybill and label the envelope: **“Notify GES Customs Brokers for Canada Customs Clearance”**
 3. Fax a copy of the *Canada Customs Invoice* to GES Customs Brokers prior to shipping your goods, and keep a copy for your on-site representative’s records.

☐ **North American Free Trade Agreement (NAFTA) Certificate of Origin Completion Instructions**

Goods and display materials entering Canada that will not be exported after the show may be subject to duty and/or tax. Under the *North American Free Trade Agreement*, you may reduce or eliminate the amount of duty that is normally payable if a properly completed *NAFTA Certificate of Origin* accompanies your shipment. This is only applicable to goods originating in other NAFTA countries: United States and Mexico.

□ **North American Free Trade Agreement (NAFTA) - cont'd....**
Certificate of Origin Completion Instructions

- Field 1 State the full legal name, address (including country) and legal tax identification number of the exporter. Legal tax identification number is: in Canada, employer number or importer/exporter number assigned by Revenue Canada; in Mexico, federal taxpayer's registry number (RFC); and the United States, employer's identification number or Social Security Number.
- Field 2 Complete field if the Certificate covers multiple shipments of identical goods as described in Field 5 that are imported into a NAFTA country for a specified period of up to one year (blanket period). "FROM" is the date upon which the Certificate becomes applicable to the goods covered by the blanket Certificate (it may be prior to the date of signing this Certificate). "TO" is the date upon which the blanket period expires. The importation of a good for which preferential tariff treatment is claimed based on this Certificate must occur between these dates.
- Field 3 State the full legal name, address (including country) and legal tax identification number, as defined in Field 1, of the producer. If more than one producer's good is included on the Certificate, attach a list of the additional producers, including the legal name, address (including country) and legal tax identification number, cross referenced to the good described in Field 5. If you wish this information to be confidential, it is acceptable to state "Available to Customs upon request". If the producer and the exporter are the same, complete field with "SAME". If the producer is unknown, it is acceptable to state "UNKNOWN".
- Field 4 State the full legal name, address (including country) and legal tax identification number, as defined in Field 1, of the importer. If importer is not known, state "UNKNOWN", if multiple importers, state "VARIOUS".
- Field 5 Provide a full description of each good. The description should be sufficient to relate it to the invoice description and to the Harmonized System (HS) description of the good. If the Certificate covers a single shipment of a good, include the invoice number as shown on the commercial invoice. If not known, indicate another unique reference number, such as the shipping order number.
- Field 6 For each good described in Field 5, identify the HS tariff classification to six digits. If the good is subject to a specific rule of origin in Annex 401 that requires eight digits, identify to eight digits, using the HS tariff classification of the country into whose territory the good is imported.
- Field 7 For each good described in Field 5, state which criterion (A through F) is applicable. The rules of origin are contained in Chapter Four and Annex 401. Additional rules are described in Annex 703.2 (certain agricultural goods), Annex 300-B, Appendix 6A (certain textile goods) and Annex 308.1 (certain automatic data processing goods and their parts). **Note: In order to be entitled to preferential tariff treatment, each good must meet at least one of the criteria below.**

Preference Criteria:

- A The good is "wholly obtained or produced entirely" in the territory of one or more of the NAFTA countries, as referred to in Article 415. Note: The purchase of a good in the territory does not necessarily render it "wholly obtained or produced". If the good is an agricultural good, see also criterion F and Annex 703.2. (Ref. Article 401(a) and 415)
- B The good is produced entirely in the territory of one or more of the NAFTA countries and satisfies the specific rule of origin, set out in Annex 401, that applies to its tariff classification. The rule may include a tariff classification change, regional value-content requirement or a combination thereof. The good must also satisfy all other applicable requirements of Chapter Four. If the good is an agricultural good, see also criterion F and Annex 703.2. (Reference: Article 401(b))
- C The good is produced entirely in the territory of one or more of the NAFTA countries exclusively from originating materials. Under this criterion, one or more of the materials may not fall within the definition of "wholly produced or obtained", as set out in Article 415. All materials used in the production of the good must qualify as "originating" by meeting the rules of Article 401(a) through (d). If the good is an agricultural good, see also criterion F and Annex 703.2. (Ref.: Article 401(c))

□ **North American Free Trade Agreement (NAFTA) - cont'd....**
Certificate of Origin Completion Instructions

- D Goods are produced in the territory of one or more of the NAFTA countries but do not meet the applicable rule of origin, set out in Annex 401, because certain non-originating materials do not undergo the required change in tariff classification. The goods do nonetheless meet the regional value-content requirement specified in Article 401(d). This criterion is limited to the following two circumstances:
1. the good was imported into the territory of a NAFTA country in an unassembled or disassembled form but was classified as an assembled good, pursuant to HS General Rule of Interpretation 2(a); or
 2. the good incorporated one or more non-originating materials, provided for as parts under the HS, which could not undergo a change in tariff classification because the heading provided for both the good and its parts and was not further subdivided into subheadings, or the subheading provided for both the good and its parts and was not further subdivided.

Note: This criterion does not apply to Chapters 61 through 63 of the HS (Reference: Article 401(d))

- E Certain automatic data processing goods and their parts, specified in Annex 308.1, that do not originate in the territory are considered originating upon importation into the territory of a NAFTA country from the territory of another NAFTA country when the Most-Favoured-Nation Tariff rate of the good conforms to the rate established in Annex 308.1 and is common to all NAFTA countries. (Reference: Annex 308.1)
- F The good is an originating agricultural good under preference criterion A, B or C above and is not subject to a quantitative restriction in the importing NAFTA country because it is a "qualifying good" as defined in Annex 703.2, Section A or B (please specify). A good listed in Appendix 703.2.B.7 is also exempt from quantitative restrictions and is eligible for NAFTA preferential tariff treatment if it meets the definition of "qualifying good" in Section A of Annex 703.2. **Note 1: This criterion does not apply to goods that wholly originate in Canada or the United States and are imported into either country. Note 2: A tariff rate quota is not a quantitative restriction.**

- Field 8 For each good described in field 5, state "YES" if you are the producer of the good. If you are not the producer of the good, state "NO" followed by (1), (2), or (3), depending on whether this certificate was based upon: (1) your knowledge of whether the good qualifies as an originating good; (2) your reliance on the producer's written representation (other than a Certificate of Origin) that the good qualifies as an originating good; or (3) a completed and signed Certificate for the good, voluntarily provided to the exporter by the producer.
- Field 9 For each good described in Field 5, where the good is subject to a regional value content (RVC) requirement, indicate "NC" if the RVC is calculated according to the net cost method; otherwise, indicate "NO". If the RVC is calculated according to the net cost method over a period of time, further identify the beginning and ending dates (DD/MM/YY) of that period. (Reference: Articles 402.1, 402.5)
- Field 10 Identify the name of the country ("MX" or "US" for agricultural and textile goods exported to Canada; "US" or "CA" for all goods exported to Mexico; or "CA" or "MX" for all goods exported to the United States) to which the preferential rate of customs duty applies, as set out in Annex 302.2, in accordance with the Marking Rules or in each Party's schedule of tariff elimination. For all other originating goods exported to Canada, indicate appropriately "MX" or "US" if the goods originate in that NAFTA country, within the meaning of the NAFTA Rules of Origin Regulations, and any subsequent processing in the other NAFTA country does not increase the transaction value of the goods by more than 7%; otherwise indicate as "JNT" for joint production. (Reference: Annex 302.2)
- Field 11 This field must be completed, signed and dated by the exporter. When the Certificate is completed by the producer for use by the exporter, it must be completed, signed and dated by the producer. The date must be the date the Certificate was completed and signed.

□ **Airline Hand Baggage**

In the event you intend on bringing any exhibit materials or commercial goods with you as hand baggage, a formal Customs clearance may be required. Contact GES Customs Brokers prior to your departure for further information.

Action □ Complete a *GES Customs/Transportation Order Form* and a *Canada Customs Invoice – CCI*, describing your materials, fax to GES and bring a copy with you. Upon arrival present the *CCI* to the Customs and Immigration officer in Toronto and inform him/her you are attending a convention/tradeshaw and GES Customs Brokers will Customs clear your goods at the show. Canada Customs will issue you a C6 document to be presented to GES Customs Brokers upon arrival at show site.

Failure to follow these instructions may result in unexpected delays or payments at the airport

□ **Private Vehicles or Company Vehicles**

In the event you will be transporting your exhibition materials to Canada with a company, rented or personal vehicle you **must** notify GES Customs Brokers, at least one week in advance of your intended date of crossing the border.

Action □ Complete all required Customs documentation including the GES Customs/Transportation Order Form, *Canada Customs Invoice – CCI* and the Private Vehicle Shipment Information Form. Fax all completed documentation to GES Customs Brokers at least one week prior to your border crossing date. Ensure the driver of the vehicle has copies of all documentation.

Failure to follow these instructions may result in unexpected delays or payments at the border

□ **Canadian Certificates or Permits**

Certain goods require Certificates or Permits before they are allowed entry into Canada. The specific kinds of materials that require certificates and/or permits are:

- ▶ Clothing/Textiles
- ▶ Animals
- ▶ Firearms
- ▶ Plants/Agriculture
- ▶ Alcohol
- ▶ Explosives
- ▶ Food
- ▶ Drugs

In the event you will be shipping any of these materials, or you are not certain if your materials are subject to special treatment, you must notify GES immediately.

□ **ATA Carnet**

The *ATA Carnet* is an internationally recognized Customs document that is similar to a passport for an individual traveler. It serves as a guarantee for the entry of materials into a country in place of the normal Customs documentation that would usually be required. An *ATA Carnet* is issued in the country of origin and provides bond coverage for the temporary importation of exhibit materials. Please contact GES for further information.

□ **Certificate of Registration (Form 4455)
For Goods that are not of U.S. Origin/Manufacture**

If you are shipping materials to Canada that are not made or produced in the USA but have been shipped from the USA and will be returning to the USA, they will require a *Certificate of Registration (Form 4455)*.

Goods that are manufactured outside the United States are dutiable each time they cross the U.S. border, unless evidence can be provided that the goods are re-entering the United States.

This form must accompany your shipment to Canada and be validated or stamped by U.S. Customs at the port of exit prior to your departure. The carrier must be instructed in writing on the Bill of Lading or Air Waybill that this form must be validated/stamped.

If you are transporting your materials by company, rented or private vehicle, it is important that you stop at U.S. Customs prior to entering Canada to have this form Validated/Stamped.

Action □ This form is not Valid unless it has been stamped and examined by U.S. Customs prior to leaving the U.S.A. An original must be provided to GES Customs Brokers at show site to be included in your documents for return to the USA.

□ **FCC Form 740 Items Capable of Emitting Radio Frequencies
An FCC Form is required for all goods capable of emitting Radio Frequencies**

The U.S. Federal Communications Commission (FCC) requires the filing of an FCC Form 740 for any radio frequency or sub assembly devices (manufactured outside the USA), which can cause harmful interference, prior to entry into the USA. A separate Form 740 is required for each model type.

Examples of Products that Emit Radio Frequencies:

A radio frequency (RF) device is any product capable of emitting radio signals while being operated, such as: computers & peripherals, telephones, video cameras & VCRs, transmitters/receivers, disk drives, video games, TV tuners.

Action □ The FCC Form must be completed and faxed to GES Customs Brokers prior to shipping your goods. Keep the original with your shipment and provide it, with your other Customs documents, to a GES Customs representative at show-site. GES must receive the original of the FCC Form 740 for submission to U.S. Authorities upon return of your shipment to the USA.

□ **FDA Form 2877 Electronic Products Capable of Emitting Radiation
An FDA Form 2877 is required for all goods capable of emitting Radiation**

The USA Food and Drug Administration (FDA) and U.S. Customs regulations state that when shipping electronic equipment that emits or is capable of emitting radiation, Form FD 2877 must be completed prior to entry into the USA. This form is required regardless of the country of manufacture.

You must verify that a certificate, in the form of an identification tag or label, is affixed to the product that states compliance with USA Food and Drug regulations.

Examples of Products that Emit Radiation.

Products that emit radiation include televisions, monitors, laser printers, CD players, X-ray equipment and laser emitting equipment and devices.

Action □ The FDA Form 2877 must be completed and faxed to GES Customs Brokers prior to shipping your goods. Keep the original with your shipment and provide it, with your other Customs documents, to a GES Customs representative at show-site. GES must receive the original of the FDA Form 2877 for submission to U.S. Authorities upon return of your shipment to the USA.

□ **Textile Declaration**

The U.S. Government requires the filing of a *Textile Declaration* for any textile products returning to the United States. This declaration would be for any products containing textiles such as carpet, drapes, t-shirts, tote bags, etc. In addition, goods from certain countries may require permits or may not be allowed re-entry into the U.S. due to trade quotas or embargo's with certain countries such as China, Singapore, Sri Lanka, etc.

Completion Instructions – See Example

1. Name of the person making the declaration.
2. Countries manufacturing the article, source of country of the textiles used in the manufacture of the article
3. Style & model numbers, colour, etc. (if applicable)
4. Name & number of items
5. Description of processing and country where processing was done
6. Date of export from Canada (date goods returning to US)
7. Description of imported material and country where the material was manufactured
8. Date material was exported from originating country

Action □ The *Textile Declaration* must be completed and faxed to GES Customs Brokers prior to shipping your goods. Keep the original with your shipment and provide it, with your other Customs documents, to a GES Customs representative at show-site. GES must receive the original for submission to U.S. Authorities upon return of your shipment to the USA.

All Customs documents must be faxed to GES prior to shipping

For additional information contact GES
the Official Customs Broker for this event.

Telephone: (403) 243-2212

Fax: (403) 243-3868 e-mail: calgary@gesexpo.com



Customs / Transportation Order Form

EXAMPLE

THE ORIGINAL OF THIS ORDER FORM MUST BE COMPLETED & RETURNED TO ENSURE CUSTOMS CLEARANCE
PLEASE ACCEPT THIS AS YOUR AUTHORITY TO PROVIDE CUSTOMS CLEARANCE AND/OR TRANSPORTATION SERVICES

WE WISH TO USE GES SERVICES FOR (PLEASE CHECK ONE)

Customs Clearance And Transportation

Customs Clearance Only

Transportation Only

SECTION 1 EXHIBITOR AND SHIPMENT INFORMATION

Exhibitor / Company Name: ABC MACHINE COMPANY

U.S. Tax # or U.S. IRS ID #: 31-2293941

Event Name & Booth #: INTERNATIONAL MACHINERY SHOW Booth #: 1430

Facility Name: MTCC - METRO TORONTO CONVENTION CENTRE - SOUTH BLDG

Shipment Date: MARCH 3, 2001 From (City): NEW YORK Carrier Name: GES LOGISTICS

It Consists of (# Cartons): 6 Weight: 1,500 lbs. kgs.

Our Rep @ Event: BILL SMITH Staying At (Hotel): RYH - ROYAL YORK Tel: 416-368-2511

PLEASE DO NOT SHIP BY PARCEL COURIER OR MAIL - WE WILL NOT BE RESPONSIBLE FOR TIMELY DELIVERY

SECTION 2 RETURN SHIPMENT CONSIGNMENT INFORMATION

Company Name: ABC MACHINE COMPANY

Delivery Address: 100 - 5TH AVENUE

City: NEW YORK Province/State: NEW YORK Postal / Zip: 10012-1010

Name: JOE BROWN Telephone: 212-286-2140 Fax Number: 212-286-2100

Ship Via: Common Carrier Our Company Vehicle Van Line Service Air Freight Service

SECTION 3 CREDIT CARD AUTHORIZATION (NOTE - THIS SECTION MUST BE COMPLETED)

I hereby authorize use of the following credit card for payment of services relative to this order form

CREDIT CARD INFORMATION MUST BE COMPLETED

Charge To: VISA MASTERCARD AMERICAN EXPRESS

Credit Card Number: 123 456 789 012 Expiry: 09 / 03

Cardholder's Name: BILL SMITH Title: DIRECTOR OF SALES

Cardholder's Signature: BILL SMITH

ORIGINAL SIGNATURE REQUIRED

SECTION 4 INVOICE / STATEMENT INFORMATION

Company Name: ABC MACHINE COMPANY

Mailing Address: 100 - 5TH AVENUE

City: NEW YORK Province/State: NY Postal / Zip: 10012-1010

Attention: BILL SMITH Telephone: 212-286-2140 Fax Number: 212-286-2100

SECTION 5 ORDER AUTHORIZED BY

This Form Was Completed By: JOE BROWN
(Please Print Full Name)

Title: DIRECTOR OF MARKETING Date: APRIL 17, 2001



Customs / Transportation Order Form

THE ORIGINAL OF THIS ORDER FORM MUST BE COMPLETED & RETURNED TO ENSURE CUSTOMS CLEARANCE
PLEASE ACCEPT THIS AS YOUR AUTHORITY TO PROVIDE CUSTOMS CLEARANCE AND/OR TRANSPORTATION SERVICES

WE WISH TO USE GES SERVICES FOR (PLEASE CHECK ONE) Customs Clearance And Transportation Customs Clearance Only Transportation Only

SECTION 1 EXHIBITOR AND SHIPMENT INFORMATION

Exhibitor / Company Name: _____

U.S. Tax # or U.S. IRS ID #: _____

Event Name & Booth #: _____ Booth #: _____

Facility Name: _____

Shipment Date: _____ From (City): _____ Carrier Name: _____

It Consists of (# Cartons): _____ Weight: _____ lbs. kgs.

Our Rep @ Event: _____ Staying At (Hotel): _____ Tel: _____

PLEASE DO NOT SHIP BY PARCEL COURIER OR MAIL – WE WILL NOT BE RESPONSIBLE FOR TIMELY DELIVERY

SECTION 2 RETURN SHIPMENT CONSIGNMENT INFORMATION

Company Name: _____

Delivery Address: _____

City: _____ Province/State: _____ Postal / Zip: _____

Name: _____ Telephone: _____ Fax Number: _____

Ship Via: Common Carrier Our Company Vehicle Van Line Service Air Freight Service

SECTION 3 CREDIT CARD AUTHORIZATION (NOTE – THIS SECTION MUST BE COMPLETED)

I hereby authorize use of the following credit card for payment of services relative to this order form

CREDIT CARD INFORMATION MUST BE COMPLETED

Charge To: VISA MASTERCARD AMERICAN EXPRESS

Credit Card Number: _____ Expiry: _____ / _____

Cardholder's Name: _____ Title: _____

Cardholder's Signature: _____

ORIGINAL SIGNATURE REQUIRED

SECTION 4 INVOICE / STATEMENT INFORMATION

Company Name: _____

Mailing Address: _____

City: _____ Province/State: _____ Postal / Zip: _____

Attention: _____ Telephone: _____ Fax Number: _____

Email: _____

SECTION 5 ORDER AUTHORIZED BY

This Form Was Completed By: _____
(Please Print Full Name)

Title: _____ Date: _____

CANADA CUSTOMS INVOICE / FACTURE DES DOUANES CANADIENNES

<p>1 Vendor (Name and Address) / Vendeur (Nom et Adresse)</p> <p>ABC MACHINE COMPANY 100-5TH AVENUE NEW YORK, NY 10012-1010</p>	<p>2 Date of Direct Shipment to Canada Date d'expédition directe vers le Canada MARCH 3, 2001</p> <p>3 Other References (Include Purchaser's Order No.) Autres références (inclure le no de commande de l'acheteur) 31-2293941 (COMPANY IRS#)</p>
--	---

<p>4 Consignee (Name and Address) / Destinataire (Nom et Adresse)</p> <p>ABC MACHINE COMPANY / BOOTH 210 INTERNATIONAL MACHINERY SHOW C/O METRO TORONTO CONVENTION CENTRE SOUTH BLDG 222 BREMNER BLVD TORONTO, ON M5V 2E6</p>	<p>5 Purchaser's Name and Address (if other than Consignee) Nom et Adresse de l'acheteur (s'il diffère du destinataire) NO SALE INVOLVED</p> <p>6 Country of Transshipment / Pays de transbordement N/A</p> <p>7 Country of Origin of Goods Pays d'origine des marchandises U.S.A.</p> <p style="font-size: small;">If shipment includes goods of different origins enter origins against items in 12 Si l'expédition comprend des marchandises d'origines différentes, en préciser la provenance en 12</p>
--	---

<p>VII. 1 Is this a related company transaction? Est-ce que les compagnies sont liées entre elles?</p> <p>Y ES <input type="checkbox"/> OUI NO <input type="checkbox"/> NON</p>	<p>9 Condition of Sales and Terms of Payment (i.e. Sale, Consignment Shipment, Leased Goods, etc.) Conditions de vente et modalités de paiement (p. Ex. Vente, Expédition en consignation, location de marchandises, etc.)</p>
---	--

<p>8 Transportation: Give Mode and Place of Direct Shipment to Canada Transport: Préciser mode et lieu d'expédition directe vers le Canada</p> <p>GES LOGISTICS NEW YORK, NY</p>	<p>10 Currency of Settlement / Devises du paiement USD</p>
--	--

11. No. of Pkgs. / Nbre. de colis	12. Specification of Commodities (Kind of Packages) Marks and Numbers, General Description and Characteristics i.e. Grade Quality / Designation des articles (Nature des colis, marques et numéros, description générale et caractéristiques. P. Ex. Classe, qualité)	13. Quantity (State Unit) / Quantité (Préciser l'unité)	Relacement Value / Valeur de Remplacement	
			14. Unit Price / Prix Unitaire	15. Total
3 PCS	WOODEN CRATES-COMPUTERS (CERTIFICATE OF REGISTRATION ATTACHED)	3	\$1,000.00	\$3,000.00
1 PC	CRATE-COMPUTER MONITOR (CERTIFICATE OF REGISTRATION ATTACHED)	1	\$ 500.00	\$ 500.00
1 PC	CARTON-ADVERTISING LITERATURE	1,000	\$ 0.10	\$ 100.00
1 PC	CARTON-PLASTIC KEY CHAINS / BOOKS	50	\$ 0.50	\$ 25.00

<p>XI.1 Total Number of Pieces / Nombre total de pièces 6</p>		
<p>18 <input type="checkbox"/> If any fields of 1 to 17 are included on an attached commercial invoice, check this box / Si les renseignements des zones 1 à 17 figurent sur la facture commerciale cocher cette case</p> <p>Commercial Invoice No. / No. De la facture commerciale</p>	<p>16. Total Weight / Poids total 1,500bs. <input checked="" type="checkbox"/>kgs.</p> <p>Net. Weight / Gross Wt./ Brut N/A 1,500 lbs</p>	<p>17. Invoice Total / Total de la facture</p>

<p>19 Exporter's Name and Address (if other than Vendor) Nom et adresse de l'exportateur (s'il diffère du vendeur)</p>	<p>20 Originator (Name and Address) Expéditeur d'origine (Nom et adresse) ABC MACHINE COMPANY 100-5TH AVENUE NEW YORK, NY 10012-1010</p> <p>Contact: BILL SMITH</p> <p>Tel: 212-268-2140 Fax: 212-268-2511</p>
<p>21 Departmental Ruling (if applicable) Decision ministérielle (s'il y a lieu)</p> <p>N/A</p>	

CANADA CUSTOMS INVOICE / FACTURE DES DOUANES CANADIENNES

1 Vendor (Name and Address) / Vendeur (Nom et Adresse)	2 Date of Direct Shipment to Canada Date d'expédition directe vers le Canada 3 Other References (Include Purchaser's Order No.) Autres références (inclure le no de commande de l'acheteur)	
4 Consignee (Name and Address) / Destinataire (Nom et Adresse)	5 Purchaser's Name and Address (if other than Consignee) Nom et Adresse de l'acheteur (s'il diffère du destinataire)	
	6 Country of Transshipment / Pays de transbordement	
	7 Country of Origin of Goods Pays d'origine des marchandises <table border="1" style="float: right; font-size: small; margin-left: 10px;"> <tr> <td style="padding: 2px;">If shipment includes goods of different origins enter origins against items in 12 Si l'expédition comprend des marchandises d'origines différentes, en préciser la provenance en 12</td> </tr> </table>	If shipment includes goods of different origins enter origins against items in 12 Si l'expédition comprend des marchandises d'origines différentes, en préciser la provenance en 12
If shipment includes goods of different origins enter origins against items in 12 Si l'expédition comprend des marchandises d'origines différentes, en préciser la provenance en 12		

VII. 1 Is this a related company transaction? Est-ce que les compagnies sont liées entre elles? Y ES <input type="checkbox"/> OUI NO <input type="checkbox"/> NON	9 Condition of Sales and Terms of Payment (i.e. Sale, Consignment Shipment, Leased Goods, etc.) Conditions de vente et modalités de paiement (p. Ex. Vente, Expédition en consignation, location de marchandises, etc.)
---	---

8 Transportation: Give Mode and Place of Direct Shipment to Canada Transport: Préciser mode et lieu d'expédition directe vers le Canada	10 Currency of Settlement / Devises du paiement
--	---

11. No. of Pkgs. Nbre. de colis	12 Specification of Commodities (Kind of Packages) Marks and Numbers, General Description and Characteristics i.e. Grade Quality Designation des articles (Nature des colis, marques et numeros, description generale et caracteristiques. P. Ex. Classe, qualite)	13 Quantity (State Unit) Quantite (Préciser l'unité)	Relacement Value Valeur de Remplacement	
			14 Unit Price Prix Unitaire	15 Total

XI.1 Total Number of Pieces / Nombre total de pieces	16. Total Weight / Poids total <input type="checkbox"/> lbs. <input type="checkbox"/> kgs. Net. Weight Gross Wt./ Brut	17. Invoice Total Total de la facture
18 <input type="checkbox"/> If any fields of 1 to 17 are included on an attached commercial invoice, check this box / Si les renseignements des zones 1 a 17 figurent sur la facture commerciale cocher cette case Commercial Invoice No. / No. De la facture commerciale		

19 Exporter's Name and Address (if other than Vendor) Nom et adresse de l'exportateur (s'il diffère du vendeur)	20 Originator (Name and Address) Expéditeur d'origine (Nom et adresse)
21 Departmental Ruling (if applicable) Decision ministerielle (s'il y a lieu)	Contact: Tel: _____ Fax: _____

North American Free Trade Agreement
Certificate of Origin

Please Print or Type

<p>1 Exporter's Name and Address</p> <p>Tax Identification Number ▶</p>	<p>2 Blanket Period</p> <p>From <table style="display: inline-table; border: 1px solid black; text-align: center;"><tr><td style="width: 20px; height: 20px;"></td><td style="width: 20px; height: 20px;"></td><td style="width: 20px; height: 20px;"></td></tr><tr><td>DD</td><td>MM</td><td>YY</td></tr></table> To <table style="display: inline-table; border: 1px solid black; text-align: center;"><tr><td style="width: 20px; height: 20px;"></td><td style="width: 20px; height: 20px;"></td><td style="width: 20px; height: 20px;"></td></tr><tr><td>DD</td><td>MM</td><td>YY</td></tr></table></p>				DD	MM	YY				DD	MM	YY
DD	MM	YY											
DD	MM	YY											
<p>3 Producer's Name and Address</p> <p>Tax Identification Number ▶</p>	<p>4 Importer's Name and Address</p> <p>Tax Identification Number ▶</p>												
<p>5 Description of Goods</p> 	<p>6 HS Tariff Classification Number</p> 	<p>7 Preference Criterion</p> 	<p>8 Producer</p> 	<p>9 Net Cost</p> 	<p>10 Country of Origin</p> 								
<p>11 I CERTIFY THAT:</p> <ul style="list-style-type: none"> The information on this document is true and accurate and I assume the responsibility for proving such representations. I understand that I am liable for any false statements or material omissions made on or in connection with this document; I agree to maintain, and present upon request, documentation necessary to support this Certificate, and to inform, in writing, all persons to whom the Certificate was given, of any changes that would affect the accuracy or validity of this Certificate; The goods originated in the territory of one or more of the Parties, and comply with the origin requirements specified for those goods in the North America Free Trade Agreement, and unless specifically exempted in Article 411 or Annex 401, there has been no further production or any other operation outside the territories of the Parties; and This Certificate consists of ___ pages, including all attachments. 													
Authorized Signature:			Company:										
Name:			Title:										
Date: <table style="display: inline-table; border: 1px solid black; text-align: center;"><tr><td style="width: 20px; height: 20px;"></td><td style="width: 20px; height: 20px;"></td><td style="width: 20px; height: 20px;"></td></tr><tr><td>DD</td><td>MM</td><td>YY</td></tr></table>					DD	MM	YY	Telephone:		FAX:			
DD	MM	YY											

North American Free Trade Agreement Certificate of Origin

Please Print or Type

1 Exporter's Name and Address <div style="border: 1px solid black; padding: 2px; width: fit-content; margin-left: auto;">Tax Identification Number ▶</div>	2 Blanket Period From <table style="display: inline-table; border-collapse: collapse;"><tr><td style="border: 1px solid black; width: 20px; height: 20px;"></td><td style="border: 1px solid black; width: 20px; height: 20px;"></td><td style="border: 1px solid black; width: 20px; height: 20px;"></td></tr><tr><td style="text-align: center; font-size: 8px;">DD</td><td style="text-align: center; font-size: 8px;">MM</td><td style="text-align: center; font-size: 8px;">YY</td></tr></table> To <table style="display: inline-table; border-collapse: collapse;"><tr><td style="border: 1px solid black; width: 20px; height: 20px;"></td><td style="border: 1px solid black; width: 20px; height: 20px;"></td><td style="border: 1px solid black; width: 20px; height: 20px;"></td></tr><tr><td style="text-align: center; font-size: 8px;">DD</td><td style="text-align: center; font-size: 8px;">MM</td><td style="text-align: center; font-size: 8px;">YY</td></tr></table>				DD	MM	YY				DD	MM	YY
DD	MM	YY											
DD	MM	YY											
3 Producer's Name and Address <div style="border: 1px solid black; padding: 2px; width: fit-content; margin-left: auto;">Tax Identification Number ▶</div>	4 Importer's Name and Address <div style="border: 1px solid black; padding: 2px; width: fit-content; margin-left: auto;">Tax Identification Number ▶</div>												
5 Description of Goods	6 HS Tariff Classification Number	7 Preference Criterion	8 Producer	9 Net Cost	10 Country of Origin								
11 I CERTIFY THAT: <ul style="list-style-type: none"> The information on this document is true and accurate and I assume the responsibility for proving such representations. I understand that I am liable for any false statements or material omissions made on or in connection with this document; I agree to maintain, and present upon request, documentation necessary to support this Certificate, and to inform, in writing, all persons to whom the Certificate was given, of any changes that would affect the accuracy or validity of this Certificate; The goods originated in the territory of one or more of the Parties, and comply with the origin requirements specified for those goods in the North America Free Trade Agreement, and unless specifically exempted in Article 411 or Annex 401, there has been no further production or any other operation outside the territories of the Parties; and This Certificate consists of ___ pages, including all attachments. 													
Authorized Signature:			Company:										
Name:			Title:										
Date: <table style="display: inline-table; border-collapse: collapse;"><tr><td style="border: 1px solid black; width: 20px; height: 20px;"></td><td style="border: 1px solid black; width: 20px; height: 20px;"></td><td style="border: 1px solid black; width: 20px; height: 20px;"></td></tr><tr><td style="text-align: center; font-size: 8px;">DD</td><td style="text-align: center; font-size: 8px;">MM</td><td style="text-align: center; font-size: 8px;">YY</td></tr></table>					DD	MM	YY	Telephone:		FAX:			
DD	MM	YY											

COMPLETE WHEN GOODS ARE NOT OF U.S.A. ORIGIN

FORM APPROVED OMB NO. 48-R0247

(NOTE: Number of copies to be submitted varies with type of transaction. Inquiries to strict Director's Office as to number of copies required.)

Via (Carrier): GES LOGISTICS	B/L or INSURED NO. Y123456	NO. _____ DATE: APRIL 17, 2000
NAME, ADDRESS AND ZIP CODE TO WHICH CERTIFIED FORM IS TO BE MAILED (If Applicable) ABC MACHINE COMPANY C/O GES CUSTOMS BROKERS 3175 AIRWAY DRIVE MISSISSAUGA, ON L4V 1C2		ARTICLES EXPORTED FOR: <input type="checkbox"/> ALTERATION <input type="checkbox"/> REPAIR * <input type="checkbox"/> USE ABROAD <input type="checkbox"/> REPLACEMENT <input type="checkbox"/> PROCESSING <input checked="" type="checkbox"/> OTHER (SPECIFY) <div style="border: 1px solid black; border-radius: 50%; padding: 2px; display: inline-block;"> EXHIBITION </div>
*NOTE: The cost or value of alterations, repairs, or processing abroad is subject to Customs duty.		

LIST ARTICLES EXPORTED

Number of Packages	Kind of Packages	Description of Articles
3	CRATES	CRATE #1 - IBM COMPUTER, SER#1710-MADE IN JAPAN CRATE #2 - PANASONIC CD, SER#210-MADE IN JAPAN CRATE #3 - ATI COLOUR MONITOR, SER#A10-MADE IN KOREA

Signature of Owner or Agent (Print or Type and Sign)			DATE
➔	TYPE NAME: <u>BILL SMITH</u>	SIGN NAME: <u>BILL SMITH</u>	<u>212-286-2140</u> TEL:
			<u>APRIL 17, 2000</u>

The Above Described Articles Were:

EXAMINED		LADEN under my supervision	
DATE	PORT	DATE	PORT
SIGNATURE OF CUSTOMS OFFICER		SIGNATURE OF CUSTOMS OFFICER	

CERTIFICATE ON RETURN

Duty-free entry is claimed for the described articles as having been exported without benefit of drawback and are returned unchanged except as noted: (use reverse if needed)

IMPORTANT: Be Sure To Mark In The Body Of Your Air Waybill Or Bill Of Lading As Follows:



U.S. CERTIFICATE OF REGISTRATION FORM 4455 ATTACHED. GOODS MUST BE EXAMINED BY U.S. CUSTOMS PRIOR TO EXPORT FROM THE U.S.A. AND CERTIFIED COPIES MUST BE GIVEN TO GES AT SHOW SITE.

If your list of goods exceeds the available space, prepare your list (as above) on a separate sheet and mark this form "exhibition material as per attached". Please attach a copy of your list to each copy of the 4455 forms.

Signature of Owner or Agent (Print or Type and Sign) ➔ BILL SMITH - BILL SMITH	DATE: APRIL17, 2000
--	-------------------------------

NOTE: Certifying officers shall draw lines through all unused spaces with ink or indelible pencil.

CUSTOMS FORM 4455



COMPLETE WHEN GOODS ARE NOT OF U.S.A. ORIGIN

FORM APPROVED OMB NO. 48-R0247

(NOTE: Number of copies to be submitted varies with type of transaction
 Inquire at District Director's Office as to number of copies required.)

NO. _____

Via (Carrier): _____	B/L or INSURED NO. _____	DATE: _____
----------------------	--------------------------	-------------

NAME, ADDRESS AND ZIP CODE TO WHICH CERTIFIED FORM IS TO BE MAILED (If Applicable)	<p align="center">ARTICLES EXPORTED FOR:</p> <table style="width:100%"> <tr> <td><input type="checkbox"/> ALTERATION</td> <td><input type="checkbox"/> PROCESSING</td> </tr> <tr> <td><input type="checkbox"/> REPAIR *</td> <td><input type="checkbox"/> OTHER (SPECIFY) _____</td> </tr> <tr> <td><input type="checkbox"/> USE ABROAD</td> <td><u>EXHIBITION</u></td> </tr> <tr> <td><input type="checkbox"/> REPLACEMENT</td> <td></td> </tr> </table> <p>*NOTE: The cost or value of alterations, repairs, or processing abroad is subject to Customs duty.</p>	<input type="checkbox"/> ALTERATION	<input type="checkbox"/> PROCESSING	<input type="checkbox"/> REPAIR *	<input type="checkbox"/> OTHER (SPECIFY) _____	<input type="checkbox"/> USE ABROAD	<u>EXHIBITION</u>	<input type="checkbox"/> REPLACEMENT	
<input type="checkbox"/> ALTERATION	<input type="checkbox"/> PROCESSING								
<input type="checkbox"/> REPAIR *	<input type="checkbox"/> OTHER (SPECIFY) _____								
<input type="checkbox"/> USE ABROAD	<u>EXHIBITION</u>								
<input type="checkbox"/> REPLACEMENT									

LIST ARTICLES EXPORTED

Number of Packages	Kind of Packages	Description of Articles

Signature of Owner or Agent (Print or Type and Sign)	DATE
TYPE NAME: _____ SIGN NAME: _____ TEL: _____	

The Above Described Articles Were:

EXAMINED		LADEN under my supervision	
DATE	PORT	DATE	PORT
SIGNATURE OF CUSTOMS OFFICER		SIGNATURE OF CUSTOMS OFFICER	

CERTIFICATE ON RETURN

Duty-free entry is claimed for the described articles as having been exported without benefit of drawback and are returned unchanged except as noted: (use reverse if needed)

IMPORTANT: Be Sure To Mark In The Body Of Your Air Waybill Or Bill Of Lading As Follows:



U.S. CERTIFICATE OF REGISTRATION FORM 4455 ATTACHED. GOODS MUST BE EXAMINED BY U.S. CUSTOMS PRIOR TO EXPORT FROM THE U.S.A. AND CERTIFIED COPIES MUST BE GIVEN TO GES AT SHOW SITE.

If your list of goods exceeds the available space, prepare your list (as above) on a separate sheet and mark this form "exhibition material as per attached". Please attach a copy of your list to each copy of the 4455 forms.

Signature of Owner or Agent (Print or Type and Sign)	DATE:

NOTE: Certifying officers shall draw lines through all unused spaces with ink or indelible pencil.

CUSTOMS FORM 4455

INSTRUCTIONS FOR COMPLETION OF FCC FORM 740

This form must be completed for each radio frequency device, as defined in 47 U.S.C. 302 and 47 C.F.R. 2.801, which is imported into the Customs territory of the United States. The original shall be filed with the U.S Customs Service on or before the date the shipment is delivered to a U.S. port of entry.

The completed form must accompany each such entry.

The following are typical examples of devices that require the use of FCC Form 740: radio and TV receivers, converters, transmitters, transmitting devices, radio frequency amplifiers, microwave ovens, industrial heaters, ultrasonic equipment, transceivers, and computers.

Marketing, as used in this form (and 47 C.F.R. 2.1201 et seq.), means sale or lease (including advertising for sale or lease, or display at a trade show) or import, ship or distribute for the purpose of selling or leasing or offering for sale or lease.

Limited quantities, as used in this form, are the number specified in 47 C.F.R. 2.1204(a)(3). Waivers of this limit are infrequently granted but may be requested from the FCC office listed in 47 C.F.R. 2.1204(a)(3)(iii). Written waiver requests must contain specific information required by that office.

Equipment imported for test, evaluation or display (see import conditions 3 or 4 of Part II of this form) may not be marketed (sold or leased, offered for sale or lease, advertised, etc.). Display of this equipment must include markings clearly indicating that the device(s) are not eligible for sale. See 47 C.F.R. 2.803 for details regarding this labeling.

Wireless telephony devices that do not have a FCC grant of equipment authorization must either comply with 47 C.F.R. 2.1204(a)(5) or 47 C.F.R. 2.803(a)(2) (e.g., Verification or Declaration of Conformity is required).

The identification (company name and model number/FCC ID) of the radio frequency device specified on the front of this form must be identical to the company name and model number/FCC ID inscribed on the device. If the device being imported requires an equipment authorization to be issued by the FCC (e.g., Certification), it is important that the name of the company, description of the device and FCC ID specified on the grant of equipment authorization agree exactly with the same information shown on the front of this form. Any discrepancy between the information on this form and the FCC grant of equipment authorization may result in unnecessary delays, additional expense, or enforcement action.

FCC Form 740 may be reproduced provided the following conditions are met (see 47 C.F.R. 0.409, Commission Policy on Private Printing of FCC Forms.) Some of the conditions are listed below:

1. That private companies reproducing the form use a printing process resulting in a product that is comparable to the original document;
2. That private companies reproducing the form refrain from including therein or attaching thereto any advertising matter or deleting any material from the form;
3. That private companies reproducing the form exercise care that the form being reproduced or distributed is the current edition presently used by the FCC for the type of application involved: such private company to be advised that, though the Commission will endeavor to keep the public advised of revisions of the form, it cannot assume responsibility to the extent of eliminating any element or risk against overstocking, etc.

PAPERWORK REDUCTION ACT STATEMENT AND PRIVACY ACT STATEMENT

The solicitation of information requested on this form is authorized by the Communications Act of 1934, as amended. The information collected will be used to ascertain whether equipment authorization is required, and if so, whether or not it has been granted. If all the information is not provided the importation of this or other shipments may be delayed or prevented. Accordingly, every effort should be made to provide all necessary information. Your response is required to obtain a benefit.

Public reporting for this collection of information is estimated to average .04 seconds per response, including the time for reviewing instructions searching existing data sources, gathering and maintaining the data needed, and completing and reviewing the collection of information. Comments regarding this burden estimate or any other aspect of this collection of information, including suggestions for reducing the burden, should be sent to the Federal Communications Commission, Performance and Evaluations and Records Management, Washington, DC 20554, Paperwork Reduction Project (3060 0059) DO NOT SEND COMPLETED FORMS TO THIS ADDRESS. Individuals are not required to respond to a collection of information unless it displays a currently valid OMB control number.

THE FOREGOING NOTICE IS REQUIRED BY THE PRIVACY ACT OF 1974, P.L. 93 579, DECEMBER 31, 1974, 5 U.S.C. 552A(E)(3), AND THE PAPERWORK REDUCTION ACT OF 1995, P.L. 104 13, OCTOBER 1, 1995, 44 U.S.C. 3507.

**STATEMENT REGARDING THE IMPORTATION OF RADIO FREQUENCY DEVICES CAPABLE OF
CAUSING HARMFUL INTERFERENCE**

(Read instructions before completing form. Please type or print clearly in ink.)

Part I All Blocks MUST Be Completed				
Date of Entry	Entry Number	Port of Entry ¹	Harmonized Tariff Number ²	Quantity of Item (not number of containers) ³
Please leave these fields blank.				

Device Model/Type Name or #	Trade Name	FCC ID	Description of Equipment

Manufacturer's Name and Address	Consignee's Name and Address	Importer's Name and Address

Printed or Typed Name of Importer or Consignee	Signature of Importer or Consignee	Date (Month/Day/Year)

Warning: Any person who knowingly makes a false declaration may be fined not more than \$250,000 or imprisoned not more than 5 years, or both, pursuant to 18 U.S.C. § 1001.

Part II With Regard to the Importation of the Described Radio Frequency Device(s), I DECLARE THAT: (Place an "X" in only one box)	
<input type="checkbox"/>	1. The FCC has issued a grant of equipment authorization for the FCC ID listed above.
<input type="checkbox"/>	2. An FCC grant of equipment authorization and an FCC ID are not required, but the equipment complies with FCC technical requirements.
<input type="checkbox"/>	3. The described equipment is being imported in limited quantities for testing and evaluation for compliance with technical requirements or marketing suitability. The equipment will not be offered for sale or otherwise marketed. (See Instructions)
<input type="checkbox"/>	4. The described equipment is being imported in limited quantities for demonstration at industry trade shows and will not be offered for sale or otherwise marketed. (See Instructions)
<input type="checkbox"/>	5. The described equipment is being imported solely for export. It will not be offered for sale or otherwise marketed in the U.S.
<input type="checkbox"/>	5(a). The described equipment is a non U.S. standard cellular phone that can only function outside of the U.S. (See Instructions)
<input type="checkbox"/>	6. The described equipment is being imported for use exclusively by the U.S. Government.
<input type="checkbox"/>	7. Three or fewer radio receivers, computers, or other unintentional radiators as defined in Part 15 of the FCC Rules, are being imported for an individual's personal use and are not intended for sale.
<input type="checkbox"/>	8. The described equipment is being imported for repair and will not be offered for sale or otherwise marketed.

1. Port of Entry Use Schedule D Classification of U.S. Customs Districts and Ports for U.S. Foreign Trade Statistics a four digit code i.e., New York City, NY 1001.
2. Harmonized Tariff Number Harmonized Tariff Schedule of the United States.
3. This quantity must be total number of items, not number of containers.

**DECLARATION FOR IMPORTED
ELECTRONIC PRODUCTS SUBJECT TO
RADIATION CONTROL STANDARDS**

INSTRUCTIONS

1. If submitting entries electronically through ACS/ABI, hold FDA-2877 in entry file. Do not submit to FDA unless requested.
2. If submitting paper entry documents, submit the following to FDA:
 - a. 2 copies of Customs Entry Form (e.g. CF 3461, CF 3461 Alt, CF 7501, etc.)
 - b. 1 copy of FDA 2877
 - c. Commercial Invoice(s) in English.

U.S. CUSTOMS PORT OF ENTRY		ENTRY NUMBER	DATE OF ENTRY
NAME & ADDRESS OF MANUFACTURING SITE; COUNTRY OF ORIGIN		NAME & ADDRESS OF IMPORTER & ULTIMATE CONSIGNEE (if not importer)	
PRODUCT DESCRIPTION	QUANTITY (Items/Containers)	MODEL NUMBER(S) & BRAND NAME(S)	

DECLARATION: I / WE DECLARE THAT THE PRODUCTS IDENTIFIED ABOVE: (Mark X applicable statements, fill in blanks, & sign)

- A. ARE NOT SUBJECT TO RADIATION PERFORMANCE STANDARDS BECAUSE THEY:**
- 1. Were manufactured prior to the effective date of any applicable standard; Date of Manufacture _____.
 - 2. Are excluded by the applicability clause or definition in the standard or by FDA written guidance.
Specify reason for exclusion _____.
 - 3. Are personal household goods of an individual entering the U.S. or being returned to a U.S. resident. (Limit: 3 of each product type).
 - 4. Are property of a party residing outside the U.S. and will be returned to the owner after repair or servicing.
 - 5. Are components or subassemblies to be used in manufacturing or as replacement parts (NOT APPLICABLE to diagnostic x-ray parts).
 - 6. Are prototypes intended for on going product development by the importing firm, are labeled "FOR TEST/EVALUATION ONLY," and will be exported, destroyed, or held for future testing (i.e., not distributed). (Quantities Limited - see reverse.)
 - 7. Are being reprocessed in accordance with P.L. 104-134 or other FDA guidance, are labeled "FOR EXPORT ONLY," and will not be sold, distributed, or transferred without FDA approval.
- B. COMPLY WITH THE PERFORMANCE STANDARDS WHICH ARE APPLICABLE AT DATE OF MANUFACTURE AND THAT A CERTIFICATION LABEL OR TAG TO THIS EFFECT IS AFFIXED TO EACH PRODUCT. COMPLIANCE DOCUMENTED IN:**
- 1. Last annual report or Product/Initial report
ACCESSION NUMBER of Report _____ Name of MANUFACTURER OF RECORD (Filed report with FDA/CDRH) _____
 - 2. Unknown manufacturer or report number; State reason: _____
- C. DO NOT COMPLY WITH PERFORMANCE STANDARDS; ARE BEING HELD UNDER A TEMPORARY IMPORT BOND; WILL NOT BE INTRODUCED INTO COMMERCE; WILL BE USED UNDER A RADIATION PROTECTION PLAN; AND WILL BE DESTROYED OR EXPORTED UNDER U.S. CUSTOMS SUPERVISION WHEN THE FOLLOWING MISSION IS COMPLETE:**
- 1. Research, Investigations/Studies, or Training (attach Form FDA 766)
 - 2. Trade Show/Demonstration; List dates & use restrictions _____
- D. DO NOT COMPLY WITH PERFORMANCE STANDARDS; ARE HELD AND WILL REMAIN UNDER BOND; AND WILL NOT BE INTRODUCED INTO COMMERCE UNTIL NOTIFICATION IS RECEIVED FROM FDA THAT PRODUCTS HAVE BEEN BROUGHT INTO COMPLIANCE IN ACCORDANCE WITH AN FDA APPROVED PETITION. (See Form FDA 766.)**
- 1. Approved Petition is attached. 2. Petition Request is attached. 3. Request will be submitted within 60 days.

WARNING: Any person who knowingly makes a false declaration may be fined not more than \$10,000 or imprisoned not more than 5 years or both, pursuant to Title 18 U.S.C. 1001. Any person importing a non-compliant electronic product may also be subject to civil penalties of \$1000 per violation, up to a maximum \$300,000 for related violations pursuant to Title 21 U.S.C. 360pp.

SIGNATURE OF IMPORTER OF RECORD

NAME AND TITLE OF RESPONSIBLE PERSON

Public reporting burden for this collection of information is estimated to average 0.2 hour per response, including the time for reviewing instructions, searching existing data sources, gathering and maintaining the data needed, and completing reviewing the collection of information. Send comments regarding this burden estimate or any other aspect of this collection of information, including suggestions for reducing this burden to:

Food and Drug Administration
CDRH (HFZ-342)
2094 Gaither Road
Rockville, MD 20850

An agency may not conduct or sponsor, and a person is not required to respond to, a collection of information unless it displays a currently valid OMB control number.

INSTRUCTIONS TO IMPORTERS/BROKERS OF ELECTRONIC PRODUCTS

PURPOSE: The Form FDA 2877 must be completed for electronic products subject to Radiation Control Standards (21 CFR 1010 and 1020-1050) prior to entry into the United States. The local Food and Drug Administration (FDA) district office will review the declaration and notify the importer/agent if the products may be released into U.S. commerce or if they must be held under bond until exported, destroyed, or reconditioned. Until the shipment is released, it may be subject to redelivery for FDA examination.

PAPER OR ELECTRONIC SUBMISSION: Paper entries may be made by submitting the signed original FDA 2877 along with U.S. Customs forms to the local FDA district office; if electronic products are given a MAY PROCEED, a signed copy of CF 3461 will be returned, or if not given a MAY PROCEED, a FDA Notice of Action will be issued. For electronic entries, follow U.S. Customs Service ACS/ABI format and procedures, supported by a signed copy of this form or similar letter. Multiple entries of the same product and model families that are filed electronically may be supported by one form dated not more than 12 months previously.

DECLARATION: Select A, B, C, or D and then select the appropriate number; fill in requested information and sign. For electronic entries, AofC (affirmation of compliance) = RA#, RB#, RC#, or RD# (e.g., Radiation Declaration A5 = RA5). **Transmit model number using AofC code MDL and transmit brand name using FDA line level brand name field. If RA3 or RA6 is selected, you must transmit quantity (number of units) using the Quantity and Unit of Measure Pairs at the FDA line level.**

DECLARATION A: Importers should be prepared to demonstrate compliance to or non-applicability of FDA standards, regulations, or guidance. Components or sub-assemblies must be non-functioning. Products being reprocessed must be exported by the importer, without intermediate transfer of ownership. For RA3 the quantity limit is 3 and for RA6 the limit = 50 units TV products, microwave ovens, and Class 1 laser products limit = 200 units CD-ROM and DVD (digital versatile disc) laser products; see May 14, 1997, notice to industry issued by the Center for Devices and Radiological Health (CDRH).

DECLARATION B: If declaration RB1 is selected, provide the FDA Establishment Identifier (FEI) of the manufacturer who filed the radiation product/abbreviated report to FDA, CDRH, Rockville, Maryland. To transmit the accession number of that report use AofC code ACC. If the manufacturer cannot be determined or located, the importer must be able to provide evidence showing a certification (certifi.) label on each product and state reason: returned to orig exporter or certifi. label evidence. The new AofC codes (RB1, RB2) for this declaration will not be activated until a process is made available to determine the FEI of the responsible firm. Continue to use RAB in electronic transmission until the FEI query is available and industry is notified of its availability.

DECLARATION C: Noncompliant products may be imported only for research, investigations/studies, demonstration or training. They should be used only by trained personnel and under controlled conditions to avoid unnecessary radiation exposure. Product(s) will be detained by the local FDA district office. Since product(s) for which "C" Declarations are made will be under Temporary Import Bond (TIB) or equivalent, ultimate disposition is limited to export or destruction under U.S. Customs supervision when the purpose has been achieved or the length of time stated has expired. For purposes other than demonstration, the Form FDA 766, outlining protections, must be approved by FDA prior to use. The importer/broker must include with the FDA 766:

1. A full description of the subject electronic product(s).
2. The purpose for which the product(s) is being imported.
3. How the product(s) will be used.
4. Where the product(s) will be located.
5. The approximate length of time and dates the product(s) will be in this country.

For product(s) being used for trade shows/demonstrations, list the dates and use restrictions (Form FDA 766 is not required). A sign stating that the product does not comply with FDA performance standards must be displayed and viewable at all times during the use of product(s). All medical products, cabinet x-ray, or Class IIIb and IV lasers may NOT operate (turn on product(s)) at trade shows.

DECLARATION D: Noncompliant products must be brought into compliance with standards under FDA supervision and following a plan approved by FDA. The plan, documented on the Form FDA 766, must address technical requirements, labeling, and reporting. Some plans may need approval by both the CDRH and the local FDA district office. Use of this declaration is limited to occasional shipments; ongoing reconditioning is considered manufacturing that is handled through other means. Product(s) will be detained by the local FDA district office. An FDA 766 must be filed indicating the procedure intended to bring the product into compliance. This procedure will include a satisfactory corrective action plan and/or a product report. The FDA 766 must include all of the information requested under Declaration C. The approximate length of time will be for the amount of time needed to bring product(s) into compliance. Declaration D is also made for failure to provide reports, failure to certify, etc.

If an importer/broker intends to import equipment into the United States for purposes of research, investigation, studies, demonstrations, or training but also wishes to retain the option of bringing the product into compliance with the performance standard, check Declarations C and D on the FDA 2877 and insert the word "or" between the Affirmations. Note: The U.S. Customs Service will treat this entry as a "D" Declaration for purposes of duty. Such requests must be made on the FDA 766; include Items 1, 2, and 3 under Declaration C, a statement of the need to use the option "C" or "D" Declaration, a statement of how the product(s) will be brought into compliance and the approximate length of time necessary to evaluate or demonstrate the product(s) and the time necessary to bring the product(s) into compliance (both actions must be accomplished within the period of time granted by FDA). For electronic entries select Declaration RD3.

Ultimately, product(s) must be brought into compliance with the applicable standard in accordance with a corrective action plan which has been approved by the FDA. If the product(s) are not brought into compliance within the allotted time frame of the approved application and an extension is not requested of, or granted by, the FDA, the local FDA district office shall refuse entry on the shipment and require the product(s) to be either exported or destroyed under U.S. Customs supervision.

If additional guidance is needed, please contact your local FDA district office or consult the following FDA web pages: www.fda.gov/cdrh, www.fda.gov/ora/hier/ora_field_names.txt, and www.fda.gov/ora/compliance_ref/rpm_new2/contents.html.

DECLARATION OF MANUFACTURER, PRODUCER EXPORTER, OR IMPORTER OF TEXTILES & TEXTILE PRODUCTS

I, _____ (Name), declare that the articles described below and covered by the entry to which this Declaration relates were subjected to manufacturing or processing operations in, and/or incorporate materials originating in, the foreign country* or countries identified below. I declare that the information set forth in this declaration is correct and true to the best of my information, knowledge and belief.

A _____ (Country*)
 B _____ (Country*)
 C _____ (Country*)
 D _____ (Country*)
 Etc.

E _____ (Country*)
 F _____ (Country*)
 G _____ (Country*)
 H _____ (Country*)
 I _____ (Country*)

Manufacturing and/or Processing Operations			Materials		
Marks of Identification, Nos.	Declaration of Article and Quantity	Description of manufacturing and /or Processing Operations and Country* of Manufacture and/or Processing	Date of Export	Description of Material and Country* of Production	Date of Export

Date: _____ Signature: _____

Name: _____ Title: _____

Company: _____ Address: _____

*Country when used in this declaration includes territories and insular possessions of the United States. The country will be identified in the above declaration by the alphabetical designation appearing next to the named country.

Customs & Logistics Specialists

EXAMPLE



Private Vehicle Shipment Information Form



NAME OF SHOW	INTERNATIONAL MACHINERY SHOW	
EXHIBITING COMPANY	ABC MACHINE COMPANY	
ADDRESS & TELEPHONE	ROYAL YORK HOTEL	TEL: 416-368-2511
BOOTH NUMBER	1430	
PERSON IN CHARGE	BILL SMITH	
VEHICLE DRIVER'S NAME	BILL SMITH	
VEHICLE LICENSE PLATE NUMBER AND STATE	74326	STATE: FLORIDA
SHIPMENT DESCRIPTION	1 - PORTABLE DISPLAY CANISTER	
	1 - BOX PRINT LITERATURE	
SHIPMENT PIECES & WEIGHT	2 - 100 lbs	
VALUE OF SHIPMENT	\$ 1,500.00	Check One: <input checked="" type="checkbox"/> U.S. \$ <input type="checkbox"/> Cdn. \$
BORDER CROSSING POINT	FORT ERIE	
DATE AND TIME OF BORDER CROSSING	APRIL 17, 2000 4:30 pm	
NAME OF PERSON COMPLETING FORM	BILL SMITH	TEL: 212-286-2140

**IMPORTANT – PAPERWORK MUST BE PREPARED IN ADVANCE FOR BORDER-CROSSING
 PLEASE COMPLETE AND FAX ASAP TO 403-243-3868 – ATTN: CUSTOMS DEPARTMENT**

Customs & Logistics Specialists



**Private Vehicle Shipment
 Information Form**



NAME OF SHOW _____

EXHIBITING COMPANY _____

ADDRESS & TELEPHONE _____ TEL: _____

BOOTH NUMBER _____

PERSON IN CHARGE _____

VEHICLE DRIVER'S NAME _____

VEHICLE LICENSE PLATE NUMBER AND STATE _____ STATE: _____

SHIPMENT DESCRIPTION _____

SHIPMENT PIECES & WEIGHT _____

VALUE OF SHIPMENT \$ _____ Check One: U.S. \$ Cdn. \$

BORDER CROSSING POINT _____

DATE AND TIME OF BORDER CROSSING _____

NAME OF PERSON COMPLETING FORM _____ TEL: _____

**IMPORTANT – PAPERWORK MUST BE PREPARED IN ADVANCE FOR BORDER-CROSSING
 PLEASE COMPLETE AND FAX ASAP TO 403-243-3868 – ATTN: CUSTOMS DEPARTMENT**