



DISPLAY RULES AND REGULATIONS

**January 30 - February 1, 2024
Georgia World Congress Center
285 Andrew Young Intl Blvd NW
Atlanta, Ga 30313 USA**

Standard Linear (In-Line) Booth:

Standard Linear Booths, also called “in-line” booths, are generally arranged in a straight line and have neighboring exhibitors on their immediate right and left, leaving only the front of booth exposed to the aisle. The Standard Linear Booth has a depth of 10ft (3.05m). A Corner Booth is a Standard Linear Booth at the end of a series of in-line booths with exposure to intersecting aisles on two sides. All guidelines for Standard Linear Booths apply to Corner Booths.

DEPTH

All display fixtures over 4ft (1.22m) in height and placed within **10** lineal feet (3.05m) of an adjoining exhibit, must be confined to that area of the exhibitor's space which is 5ft (1.52m) from the aisle, referred to as line-of-sight.

HEIGHT

All booths will be confined to a maximum height of 8ft (2.44m).

The maximum height of 8ft (2.44m) is allowed only in the rear half of the booth space, with a 4ft (1.22m) height restriction imposed on all materials in the remaining space forward to the aisle for line-of-sight. **Note:** When three or more linear booths are used in combination as a single exhibit space, e.g. 10ft X 30ft or greater, the 4ft (1.22m) height limitation is applied only to that portion of exhibit space which is within 10ft (3.05m) of an adjoining booth. Equipment which exceeds the 8ft height limit is allowed if it is in its usual orientation or “natural state” and is in compliance with the line of sight regulations. No signs may be added to the top of such equipment. **Absolutely NO ceiling suspended signage allowed. Maximum back wall height limitation of 8ft (2.44 m). Free standing signs will NOT exceed 8ft. (2.44m) in height from floor to top of sign/sign support. Two-story booths are NOT allowed for linear booths.**

CANOPIES

Refer to details in the Canopies and Ceilings section.

IMPORTANT

Space dimensions shown on floor plan are from center line of booth equipment, such as side rails and/or back drape. Exhibit structures must be constructed to allow sufficient tolerance on each side for this equipment and for utility service at rear of booth.

WAIVERS

Two companies in adjoining booths may, by mutual agreement, waive the Line of Sight requirements herein. The agreement must be in writing, signed by each exhibiting company, and must be approved by show management. The agreement must be renewed each year as the neighboring exhibitor may move from the location, making the agreement null and void.

Note: Two open corners on a linear booth does NOT make a peninsula booth. Linear booth rules apply.

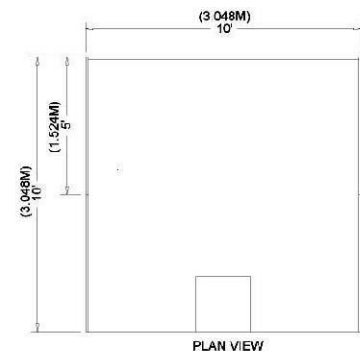
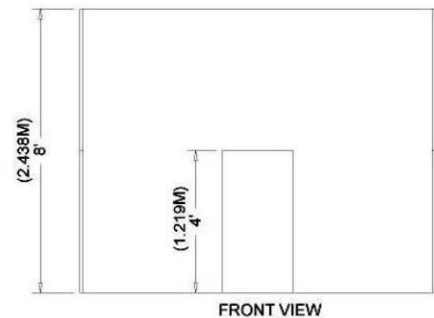
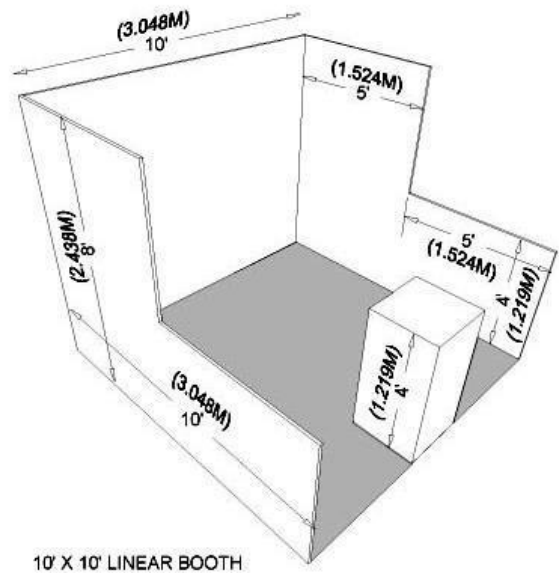

Peninsula Booth:

A Peninsula Booth is exposed to aisles on three (3) sides and comprised of a minimum of four booths. There are two types of Peninsula Booths: (a) one which backs up to Linear Booths, and (b) one which backs up to another Peninsula Booth and is referred to as a "Split Island Booth." A Peninsula booth is 20ft X 20ft or larger.

DEPTH

When a Peninsula Booth backs up to two Linear Booths, all display fixtures over 4ft (1.22m) in height must be confined to the booth area outside the 5ft x 5ft (1.52m) line-of-sight area directly adjacent to neighbor and aisle. Exceptions exist for a Split Island Peninsula Booth. Please refer to rules regarding Split Island Peninsula Booth for specifics about that booth type.

HEIGHT

Identification signs are permitted to a maximum height of 16ft (4.88m) if supported from floor structure and must be 5ft (1.52m) from adjacent booths. Ceiling-suspended signage is permitted to a maximum height of 24ft (7.32m), should be set back 5ft (1.52m) from adjacent booths, and be directly over contracted space only. Sign height is limited to 5ft (1.52m) from top of sign to bottom of sign.

Equipment which exceeds this limit (16ft) is allowed if it is in its usual orientation or "natural state" and is in compliance with the line of sight regulations. No signs may be added to the top of such equipment. **Two-story booths are NOT allowed for peninsula booth.**

Canopies and Ceilings:

Refer to details in Canopies and Ceilings section.

NOTE:

Any portion of the exhibit bordering another exhibitor's booth must have the back side of that portion finished and must not carry identification signs or other graphics. Double-sided signs, logos and graphics shall be set back 5ft (1.52m) from adjacent booths.

IMPORTANT

Space dimensions shown on floor plan are from center line of booth equipment, such as side rails and/or back drape. Exhibit structures must be constructed to allow sufficient tolerance on each side for this equipment and for utility service at rear of booth.

WAIVERS

Two companies in adjoining booths may, by mutual agreement, waive the Line of Sight requirements herein. The agreement must be in writing, signed by each exhibiting company, and must be approved by show management. The agreement must be renewed each year as the neighboring exhibitor may move from the location, making the agreement null and void.

Note: Exhibitors should submit booth designs to Expo Exhibit Manager by Oct. 31, 2023, to ensure conformity with the rules or needs for waivers. This is especially important regarding peninsula, split-island peninsula, and island booths and any ceiling-suspended signage. Two-story booths are NOT allowed for peninsula booths.

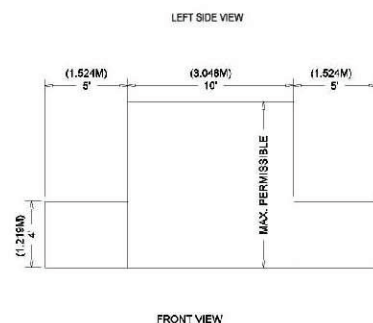
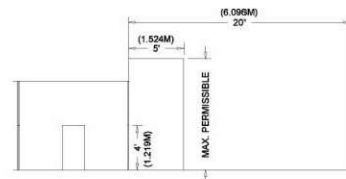
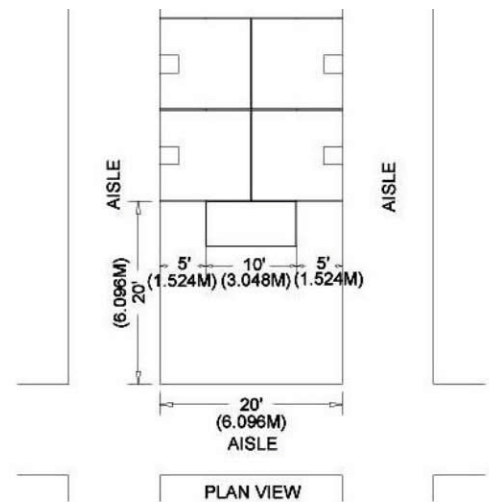
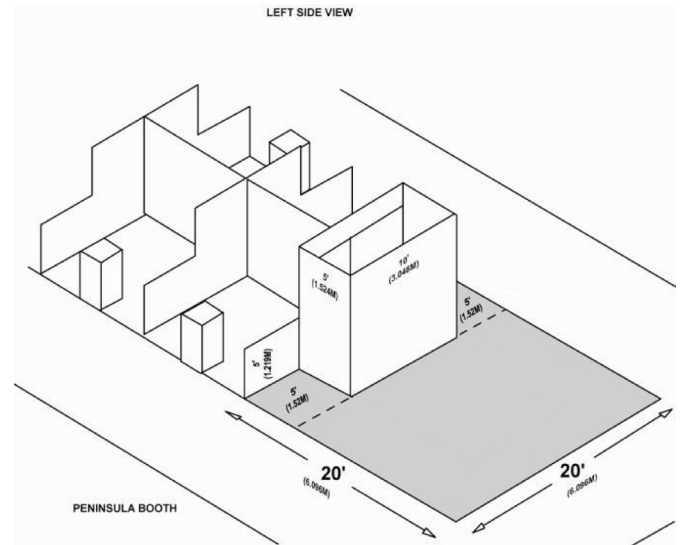

Split Island Peninsula Booth:

A Split Island Peninsula Booth is a Peninsula Booth which shares a common back wall with another Peninsula Booth. Shared back walls/curtains are permitted to extend aisle to aisle. Booths must be 20x15 or larger to qualify. Booth depth of 10ft. or less, linear booth rules apply but may have full back border display and no line-of-sight to adjoining neighbor is required.

DEPTH

For booth depth greater than 10ft., the entire cubic content of the space may be used up to the maximum height of **16ft (4.88m)**, and without any back wall/curtain line-of-sight restrictions. Back wall/display may extend aisle-to-aisle. Signage rules are the same as for Peninsula Booths.

HEIGHT

Identification signs are permitted to a maximum height of **16ft (4.88m)** if supported from floor structure and must be **5ft (1.52m)** from adjacent booths. Ceiling-suspended signage is permitted to a maximum height of **24ft (7.32m)**, should be set back **5ft (1.52m)** from adjacent booths, and be directly over contracted space only. Sign height is limited to **5ft (1.52m)** from top of sign to bottom of sign.

Equipment which exceeds the maximum height limit of **16ft (4.88m)** is allowed if it is in its usual orientation or "natural state" and is in compliance with the line of sight regulations. No signs may be added to the top of such equipment. **Two-story booths are NOT allowed for split island peninsula booth.**

Canopies and Ceilings:

Refer to details in Canopies and Ceilings section.

Any portion of the exhibit bordering another exhibitor's booth must have the back side of that portion finished and must not carry identification signs or other graphics. Double-sided signs, logos and graphics shall be set back 5ft (1.52m) from adjacent booths.

IMPORTANT

Space dimensions shown on floor plan are from center line of booth equipment, such as side rails and/or back drape. Exhibit structures must be constructed to allow sufficient tolerance on each side for this equipment and for utility service at rear of booth.

Note: Exhibitors should submit booth designs to Expo Exhibit Manager by Oct. 31, 2023, to ensure conformity with the rules or needs for waivers. This is especially important regarding peninsula, split island peninsula, and island booths and any ceiling-suspended signage. Two-story booths are NOT allowed for split-island peninsula booths.

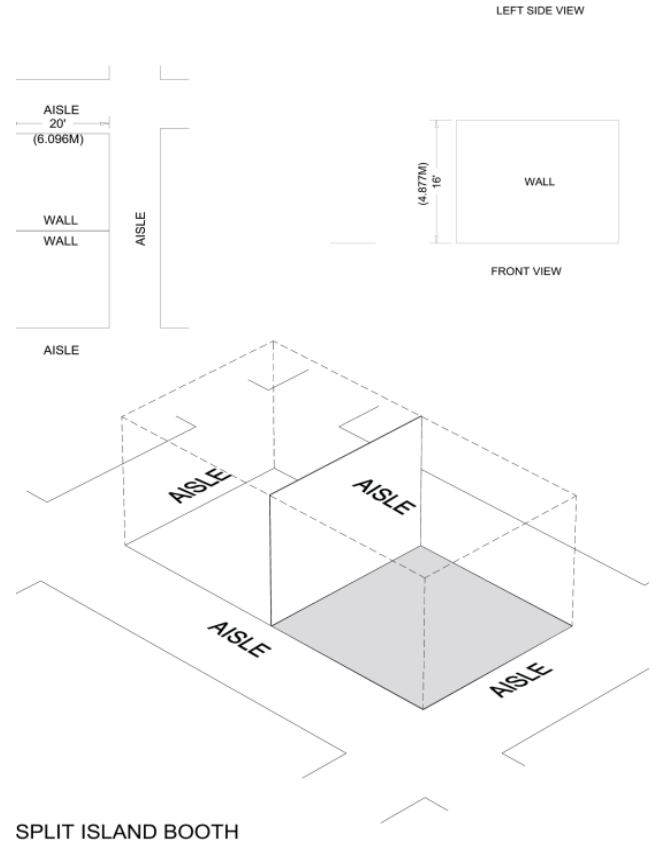

Island Booth:

An Island Booth is any size booth exposed to aisles on all four sides.

DEPTH

Display materials up to a maximum of **16ft (4.88m)** are permitted. The entire cubic content of the space may be used up to the maximum height of **16ft (4.88m)**.

HEIGHT

Identification signs are permitted to a maximum height of **16ft (4.88m)** if supported from floor structure and be contained within the contracted booth space. Ceiling-suspended signage is permitted to a maximum height of **24ft (7.32m)** and be directly over contracted booth space. Sign height is limited to **5ft (1.52m)** from top of sign to bottom of sign.

Equipment which exceeds the maximum limit **16ft (4.88m)** is allowed if it is in its usual orientation or "natural state" and is in compliance with the line of sight regulations. No signs may be added to the top of such equipment.

Canopies and Ceilings:

Refer to details in Canopies and Ceilings section.

Perimeter Openings:

Large island booths with long high walls can create a "tunnel-like" effect. **To ensure maximum traffic flow on the exhibit floor, exhibitors are required to install a minimum 6ft (1.82m) wide by 7ft (2.13m) height opening/entrance every 30ft (9.14m) of structure. No exceptions.**

NOTE:

All portions of the exhibit must be fully finished and within the confines of the contracted booth space.

IMPORTANT

Space dimensions shown on floor plan are from center line of booth equipment, such as side rails and/or back drape. Exhibit structures must be constructed to allow sufficient tolerance on each side for this equipment and for utility service at rear of booth.

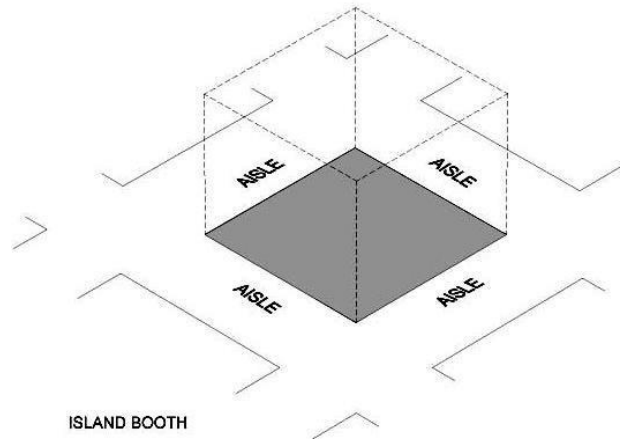
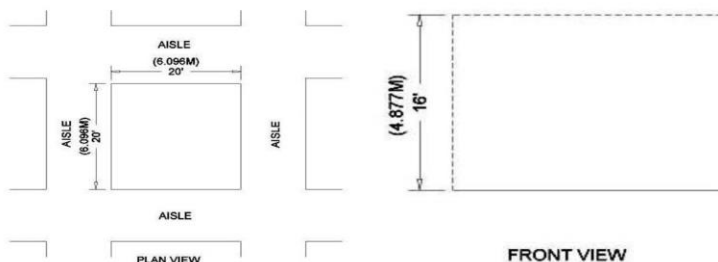

Note: Exhibitors should submit booth designs to Expo Exhibit Manager by Oct. 31, 2023, to ensure conformity with the rules or needs for waivers.

Waivers:

Waiver consideration: Structural heights up to 6m (19.75ft) may be permitted through waivers if the materials and design of the structure do not impede line of sight through the space being occupied (e.g. Use of fabrics that are semi-transparent, or display suspended above the floor is such a manner that allows line of sight through the exhibit space). Dimensional renderings must be submitted to the exhibit manager by Oct. 31 for consideration and subsequent approval or denial. Exhibitor must demonstrate that the proposed design will not adversely impact neighboring exhibitors.

MULTI-LEVEL ISLAND BOOTH

Restricted to two levels maximum. Booth space must be 900 sq. ft. or larger on base floor level to qualify for second level. Height maximum for total booth structure is 16ft (4.88m). Island booth rules apply to multi-level booths. Booth must contain smoke detector for each enclosed area and fire extinguisher on both levels (See GWCC Guidelines attached herein.)

Exhibitors with multi-level booth designs, regardless of whether people will occupy the upper level or not, must submit detailed plans to Exhibit Manager by Oct. 31, 2023. The plans must include a signature or stamp of the authorized official of the exhibit building company indicating that the structure is built in compliance with the details and specifications set forth in the plans. Signs must also be posted on the structure indicating the maximum number of people the structure will accommodate.

SEE NEXT PAGE FOR VENUE GUIDELINES FOR MULTI-LEVEL ISLAND BOOTH

MULTI-LEVEL ISLAND BOOTH – Georgia World Congress Center Guidelines

PURPOSE

The Georgia World Congress Center (GWCC) provides these guidelines to clarify the requirements for multi-story exhibit booths. The Fire Marshal has provided basic guidelines for compliance with Paragraph 9-4.4.3.7 of NFPA 101 Life Safety Code, which governs multi-level exhibit booths. In addition, the GWCC has developed additional guidelines appropriate for the safe and orderly operation of these facilities. These guidelines are as follows:

- a. Covered or roofed areas should be furnished with acceptable battery-powered smoke detectors that emit alarms audible outside of the enclosed or covered area.
- b. The exhibit will provide for a Fire Watch within the booth space. Personnel providing Fire Watch services must be supplied with a Class 2A10BC Fire Extinguisher in each enclosed area covered by the floor above. Personnel must be trained in the use of extinguishers.
- c. Spiral stairways are not recommended for areas occupied by the public, visitors or clientele, unless specifically approved.
- d. Exhibit booth plans must be submitted to Anne Sculthorpe, asculthorpe@ippexpo.org. Anne will then submit to Georgia World Congress Center Event Coordinator for review a minimum of sixty (60) days before move-in. There must be a licensed structural engineer's stamp of certification on all plans for multi-level booths.
- e. The upper deck of multilevel exhibits greater than 300 square feet in area shall have at least two remote means of egress.
- f. Areas within the exhibit booth that are totally enclosed (i.e., walls and roof/ceiling) must be served by an emergency lighting source (i.e., battery-powered) when such areas lead to exit access from the space (e.g., stairs, aisles, corridors, ramps and passageways leading to an exit from the booth space).

Large Corner Booth:

Corner booths of 600 square feet or more with and at least **20ft** (6.09m) in depth and with booths adjacent at side and back. Submit designs to Expo Exhibit Manager for approval by Oct. 31, 2023.

RULES

Same rules as Linear Booth except **SIGN HEIGHT**.

Sign Height: Identification signs are permitted to a maximum height of **16ft** (4.88m) if supported from floor structure and must be **10ft** (3.05m) from adjacent booths. Ceiling-suspended signage is permitted to a maximum height of **24ft** (7.32m), should be set back **5ft** (1.52m) from adjacent booths, and be directly over contracted space only. Sign height is limited to **5ft** (1.52m) from top to bottom.

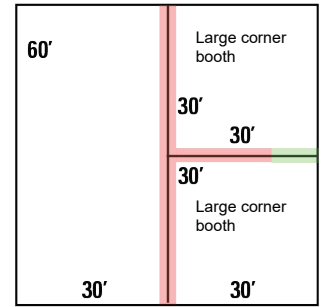

Green = Line-of-sight 4ft height maximum for structures
Red = 8ft height maximum for structures

Walk-Through Booth:

Booth space with openings on front and back of booth on two opposite aisles creating a walk-through and having adjacent booths on each side. Submit designs to Expo Exhibit Manager for approval by Oct. 31, 2023.

RULES

Same rules as Linear Booth if booth is less than 300sf. **16ft** height maximum structures allowed if booth is 300sf or greater. Must give line-of-sight to each adjacent neighbor at common borders; no full-length walls/displays along common borders with adjacent neighbors.

Sign Height Exception for booth of 400 square feet or larger: Identification signs are permitted to a maximum height of **16ft** (4.88m) if supported from floor structure and must be **10ft** (3.05m) from adjacent booths. Ceiling-suspended signage is permitted to a maximum height of **24ft** (7.32m), should be set back **5ft** (1.52m) from adjacent booths, and be directly over contracted space only. Sign height is limited to **5ft** (1.52m) from top to bottom.

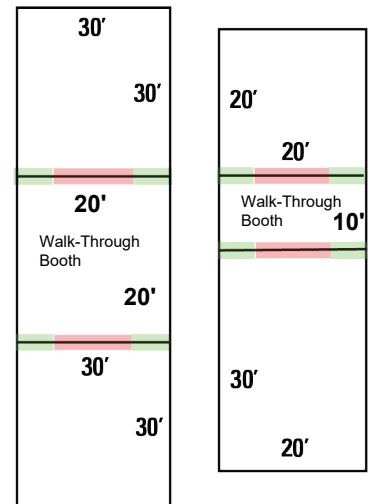

Green = Line-of-sight 4ft height maximum for structures
Red = Allowed up to height maximum for structures based on booth size

Large Linear Booth:

Linear Booth along an aisle and greater than 400 square feet with booth depth of 15ft or greater. This may also pertain to an island with four 20x20 booths (Quad). Submit designs to Expo Exhibit Manager for approval by Oct. 31, 2023.

RULES

Same rules as Linear Booth except **SIGN HEIGHT**.

Sign Height: Identification signs are permitted to a maximum height of **16ft** (4.88m) if supported from floor structure and must be **5ft** (1.52m) from adjacent booths. Ceiling-suspended signage is permitted to a maximum height of **24ft** (7.32m), should be set back **5ft** (1.52m) from adjacent booths, and be directly over contracted space only. Sign height is limited to **5ft** (1.52m) from top of sign to bottom of sign.

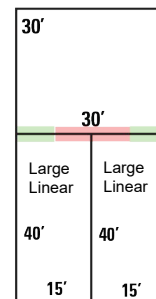

Green = Line of sight 4ft height maximum for structures
Red = 8ft height maximum for structures

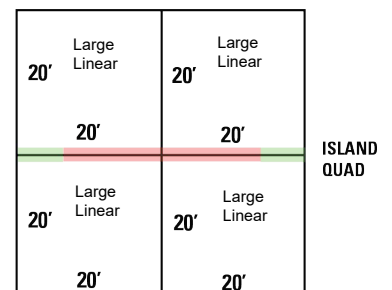

Perimeter (Fixed Wall) Booth:

Linear Booth located on a permanent wall (as opposed to a temporary or air wall).

RULES

Same rules as Linear Booth except **BACK WALL/STRUCTURE HEIGHT** and **SIGN HEIGHT**.

Structure Height: Exhibitor's back wall/structure is allowed up to **14ft** (4.27m).

Sign Height: Up to **14ft** (4.27m) supported from floor structure in back half of booth. Absolutely **NO** ceiling-suspended signs/graphics allowed.

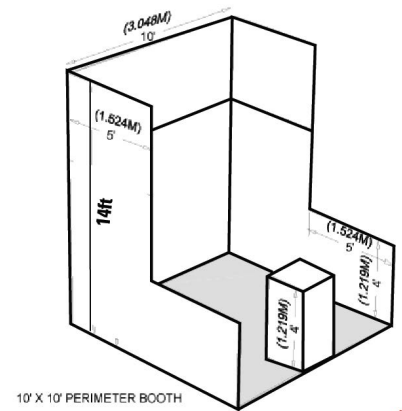

10' X 10' PERIMETER BOOTH

Vehicle Booth:

Booths displaying licensable highway vehicles; i.e., tractor trailers, buses, etc. Submit booth layout design to Expo Exhibit Manager for approval by Oct. 31, 2023.

RULES

Same rules as Island Booth. **BOOTH MUST BE FULLY CARPETED.**

Minimum Depth: Must be at least **15ft** in depth and **10ft** longer than vehicle. There must be **5ft** of walking space around entire vehicle in order to conduct business within booth space and not in aisle.

GWCC Policy: Gas vehicles and diesel vehicles on display must have a maximum of 1/4 tank or 5 gallons (19L) whichever is less. A locking gas cap must be in place, or the tank must be adequately sealed off. Battery cables must be disconnected and taped to avoid sparking except where fire code official requires that the battery be connected to maintain safety features. All vehicles on display are subject to Fire Marshal approval onsite.

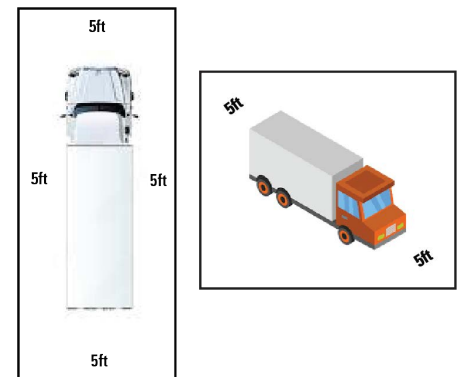

End Cap Booth:

An End-Cap Booth is a linear booth exposed to aisles on three sides and comprised of two linear booth increments. End-Cap Booths are generally **10ft** (3.05m) deep by **20ft** (6.10m) wide. **These booths are NOT Peninsula Booths.**

RULES

Same rules as Linear Booth.

End-Cap Booths do **NOT** qualify for ceiling-suspended signs and graphics. End-Cap booths must adhere to line-of-sight height restriction of **4ft** (1.22m) within first five feet from each side aisle. **No full back border displays/walls.**

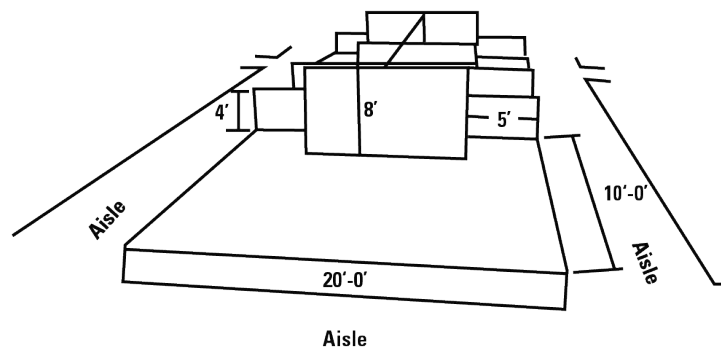

Signage & Graphics

There are two distinct types of signage: (1) Identification signs either suspended from the ceiling or (2) extended from a floor structure.

- Peninsula, Perimeter, Large Linear, Large Corner, Walk-Through and Island Booths are permitted to have identification signs to a maximum height of **16ft (4.88m)** if supported from floor structure and must be **5ft (1.52m)** from adjacent booths.
- Peninsula, Large Linear, Large Corner, Walk-Through and Island Booths are permitted to have ceiling-suspended signage to a maximum height of **24ft (7.32m)**, should be set back **5ft (1.52m)** from adjacent booths, and be directly over contracted space only. Sign height is limited to **5ft (1.52m)** from top of sign to bottom of sign.
- Whether suspended from above, or supported from floor structure, signs should comply with all ordinary use-of-space requirements. For example, the highest point of any sign should not exceed the maximum allowable height for the booth type. **Black fire retardant fabric must be used to cover the backside of unsightly lighted display components such as aerial LED screens or suspended digital walls that can be seen from aisle.**
- End-Cap Booths and/or Linear Booths do NOT qualify for hanging signs and graphics.

Lighting

Exhibitors should adhere to the following minimum guidelines when determining booth lighting:

- No lighting, fixtures, lighting trusses, or overhead lighting are allowed outside the boundaries of the exhibit space. Exhibitors intending to use hanging light systems should submit drawings to Exhibit Manager for approval.
- Lighting, including gobos, should be directed to the inner confines of the booth space. Lighting should not project onto other exhibits or exhibition aisles.
- Lighting that is potentially harmful, such as lasers, ultraviolet lights or flashing or strobe lights that can trigger photosensitive epilepsy should comply with facility rules and be approved in writing by Exhibit Manager.
- Lighting that spins, rotates, pulsates, and other specialized lighting effects should be in good taste and not interfere with neighboring exhibitors or otherwise detract from the general atmosphere of the event.
- LED lights can be very bright yet generally generate less heat.
- Currently, some convention facilities are not allowing certain types of quartz halogen lighting fixtures in exhibits due to potential fire hazards. Check with Exhibit Manager.
- Reduced lighting for theater areas should be approved by Exhibit Manager, the utility provider, and the exhibit facility.

Canopies and Ceilings

- Canopies, including ceilings, umbrellas and canopy frames, can be either decorative or functional (such as to shade computer monitors from ambient light or to allow for hanging products).
- Canopies for Linear or Perimeter Booths should comply with Line-of-Sight requirements, as well as height maximum.
- Smoke detector and fire extinguisher are required for any covered or enclosed area of booth.
- The bottom of the canopy should not be lower than **7ft (2.13m)** from the floor. Canopy supports should be no wider than three inches (**3" or .08m**). This applies to any booth configuration that has a sight line restriction, such as a Linear Booth.
- **Please submit design to Expo Exhibit Manager for approval by Oct. 31, 2023.**

Towers

A tower is a free-standing exhibit component separate from the main exhibit fixture. The height restriction is the same as that which applies to the appropriate exhibit space configuration being used.

Exhibitors with towers in excess of 8ft (2.44m) should submit designs to Expo Exhibit Manager for approval by Oct. 31, 2023. Fire and safety regulations strictly govern the use of towers. A building permit or safety lines may be required.

Carpeting

All booths must be fully carpeted. This includes vehicle island booths.

Machinery/Equipment Setback

Machinery should be setback from booth border a minimum of **1ft (.30m)** to prevent accidental injury to aisle pedestrians. Exhibitors should exercise special caution when demonstrating machinery or equipment (robots included) that has moving parts and should establish a minimum setback of **3ft (.91m)** and/or install hazard barriers as necessary to prevent accidental injury to spectators. Additionally, demonstrations should only be conducted by qualified personnel.