

Exhibitor Services Manual Table of Contents

All orders are governed by the GES Payment Policy and GES Terms & Conditions of Contract as specified in this Exhibitor Services Manual.

Forest Products Machinery & Equipment Exposition
 Georgia World Congress Center
 June 14 - 16, 2017

GES Information and Order Forms	3
Show Information	4
Show Information	4
General Information	6
Tips for New Exhibitors	7
Required Forms	9
Payment and Credit Card Charge Authorization	9
Domestic Third Party Billing Request	10
International 3rd Party Billing Request	11
Booth Furnishings	12
Carpet Brochure	12
Carpet Order Form	13
Carpet Package Order Form	14
Standard Furniture Brochure	15
Furniture & Accessories Order Form	17
Furniture Package Order Form	20
Specialty Furniture Brochure	21
Specialty Furniture Order Form	30
Convenience Package Order Form	36
Standard Exhibit Systems Brochure	38
Standard Exhibit Systems Order Form	45
Digital File Preparation	47
Graphics & Signage Order Form	49
Standard Graphics Brochure	50
Shipping, Drayage and Material Handling	51
Material Handling/Drayage Information	51
GES Transportation Plus	54
Material Handling/Drayage Order Form	55
Special Handling Brochure	57
Advance Shipping Labels	58
Direct Shipping Labels	59
Pre-Printed Bill of Lading (BOL) / Outbound Labels Request	60
Freight Service Questionnaire	61
Marshaling Yard & Direct Deliveries Information	62
Targeted Move-in and Freight Information	63
Request for Variance to Assigned Target Time	64
Cartload Service Order Form	65
Vehicle Placement Order Form	66
Labor and Equipment	67
Installation and Dismantling Order Form	67

051600379

040417

Exhibitor Services Manual Table of Contents

All orders are governed by the GES Payment Policy and GES Terms & Conditions of Contract as specified in this Exhibitor Services Manual.

Forest Products Machinery & Equipment Exposition
Georgia World Congress Center
June 14 - 16, 2017

Forklift Order Form	69
Crane / Versa Lift Order Form	71
Hanging Sign / Truss Labor Information	74
Hanging Sign Labor Order Form	75
Booth Layout - Hanging Signs	79
Hanging Sign Shipping Labels	80
Cleaning and Porter Service Order Form	81
Exhibitor Appointed Contractors (EACs) and Third Parties	82
Notice of Intent to Use EAC and Policies and Procedures	82
Agreement and Rules and Regulations between GES and EAC	83
Certificate of Liability Insurance Sample	85
Regulations and Guidelines	86
Show Site Work Rules	86
Stop. Think. Safety.	87
Operation of All Mechanical Lifts	88
GES Payment Policy	89
GES Terms and Conditions of Contract	90
Index	93

051600379

040417

One Place for Exhibit Planning Ordering and Management

ExpressoSM by GES is a simple to navigate, picture-driven system customized specifically for your show.

It's more than just your exhibitor manual online.

Exhibitors can:

- Order exhibit products and services for multiple booths
- View account order history
- View important show and event information
- Track small packages and inbound shipments
- Download the show schedule into Outlook or iCalendar
- Print shipping labels
- Chat with our award-winning GES National ServicerSM

Order Everything You Need for Your Show



- Go to <https://e.ges.com/051600379/esm>
- Log in or sign up with a new account
- Browse products and services and you will be guided through the ordering process

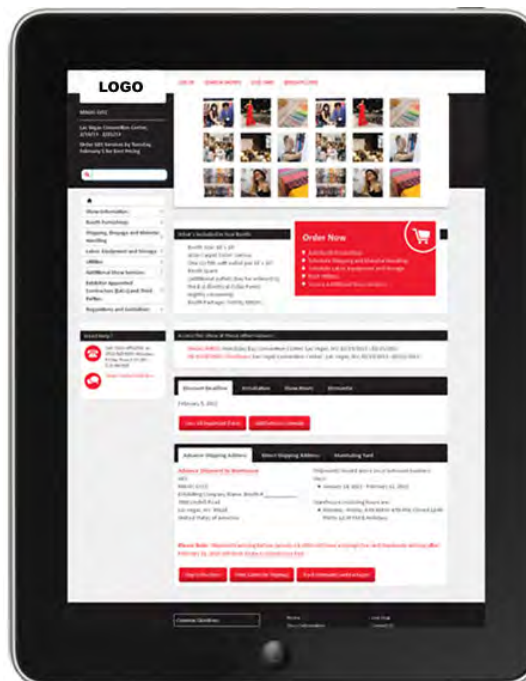

Show Information

All orders are governed by the GES Payment Policy and GES Terms & Conditions of Contract as specified in this Exhibitor Services Manual.

Forest Products Machinery & Equipment Exposition
Georgia World Congress Center
June 14 - 16, 2017

Questions?



Contact

- Chat with us <http://www.ges.com/chat>
- Contact us online: <https://e.ges.com/051600379/contactus/esm>

Official Service Provider

Global Experience Specialists, Inc. (GES) Phone (in USA): 800.475.2098 International Calls: 702.515.5970
7000 Lindell Road FAX (in USA): 866.329.1437 International Faxes: 702.263.1520
Las Vegas, NV 89118-4702

GES will be onsite to assist you in coordinating any last minute services, order additional products, and to answer any questions you may have.

Show Information

Standard Booth Package:

Booth Size: 10' x 10'
Backwall Drape: Black / Gray / Gray / Gray / Black
Sidewall Drape: Black
Aisle Carpet Color: Pepper
Booth Carpet: Black

Discount Deadline Date

Monday, May 22 GES orders must be received with payment by this date.

Exhibitor Move In

Sunday, June 11	12:00 PM - 5:00 PM	Targeted Exhibitors
Monday, June 12	8:00 AM - 5:00 PM	Targeted Exhibitors
Tuesday, June 13	8:00 AM - 5:00 PM	All Exhibitors

Show Hours

Wednesday, June 14	9:00 AM - 5:00 PM
Thursday, June 15	9:00 AM - 5:00 PM
Friday, June 16	9:00 AM - 1:00 PM

Exhibitor Move Out

Friday, June 16	1:00 PM - 10:00 PM
Saturday, June 17	8:00 AM - 10:00 PM

Carrier Check-in Post-Show

Saturday, June 17 10:00 AM Carriers post-show must be checked-in by this time.

Facility Clear

Saturday, June 17 10:00 PM All exhibitor materials must be removed.

040417 051600379

G-1 012617

Shipping Addresses: Use provided Shipping Labels in this Exhibitor Services Manual to expedite handling

Advance Shipments to Warehouse:

c/o GES
Forest Products Machinery & Equipment
Exposition
(Your Company Name & Booth Number)
RAC Logistic LLC
4351 Thurman Road
Conley, GA 30288
USA

Shipments should arrive on or between:

May 9 - June 7, 2017
Hours for receiving are Monday - Friday, 8:00 AM - 4:30 PM

Direct Shipments to Show Site:

c/o GES
Forest Products Machinery & Equipment
Exposition
(Your Company Name & Booth Number)
Georgia World Congress Center
285 Andrew Young Intl Blvd NW
Atlanta, GA 30313
USA

Shipments should arrive on:

June 11, 2017, 12:00 PM - 5:00 PM
June 12, 2017, 8:00 AM - 5:00 PM
June 13, 2017, 8:00 AM - 5:00 PM
*Please reference targeted floor plan

Marshaling Yard Site Address:

362 Ivan Allen Jr. Blvd. NW
Atlanta, GA 30313
USA

040417 051600379

G-1 012617



General Information

All orders are governed by the GES Payment Policy and GES Terms & Conditions of Contract as specified in this Exhibitor Services Manual.

Forest Products Machinery & Equipment Exposition
Georgia World Congress Center
June 14 - 16, 2017

What is an Official Service Provider?

- GES has been selected as the Official Service Provider by the show organizer to design and produce your show.
- We can save you time and money with our insight and experience of the show process. As the Official Service Provider GES will assist you in your pre-show planning from start to finish.
- We are at your service for all your exhibiting needs.

GES Show Services

- Carpet
- Booth Furniture and Accessories
- Custom Exhibits and Rental Exhibits
- Graphics
- Installation and Dismantle Services
- Overhead Lighting and Rigging

Work Zone



- Customer acknowledges that the show site and surrounding areas are active work zones. Customer, its agents, employees and representatives are present on the show floor at their own risk.

How Can I Order My Show Services?



Expresso is GES' planning, ordering and management system. Order everything you need for your tradeshow exhibits, view account order history, download the show schedule and more.

- Go to <https://e.ges.com/051600379/esm>
- Log in or sign up with a new account
- Browse products and services and you will be guided through the ordering process



GES National Servicenter® provides consistency and continuity of customer service for exhibitors at shows:

- Phone: (800) 475-2098 / Fax: (866) 329-1437
- International phone: (702) 515-5970 / Fax: (702) 263-1520
- Contact us online: <https://e.ges.com/051600379/contactus/esm>

GES Servicenter® is on-site to place any last-minute orders and provide show information while at showsite.

Exhibitor Services

- Our Exhibitor Services team is responsible for answering exhibitor questions, processing your orders and handling any special requests.

051600379

040417

G-11 122016

Tips for New Exhibitors

All orders are governed by the GES Payment Policy and GES Terms & Conditions of Contract as specified in this Exhibitor Services Manual.

Forest Products Machinery & Equipment Exposition
Georgia World Congress Center
June 14 - 16, 2017

First Time Exhibitors

Exhibiting for the first time can be confusing and stressful. GES is here to make your ordering process as simple and stress free as possible. GES will be on-site at the show to assist you in coordinating any last minute services, order additional products and answer any questions you may have. Save money by ordering early! Order by the Discount Deadline of May 22, 2017 for best pricing.

For quick and easy ordering, visit the Espresso online ordering site: <http://e.ges.com/051600379/esm>

Details Matter When Shipping

Material Handling is the unloading of your exhibit materials. The service includes delivery to your booth, handling of empty containers to and from storage and removal of your materials from your booth for reloading onto your outbound carrier. This is not to be confused with the cost to transport your exhibit material to and from the event.

- Unloading the freight and delivery to your booth is not included. Avoid unexpected costs at show site and estimate the cost for this service. <http://e.ges.com/051600379/item/200500>
- We understand that your calculation is only an estimate. Invoicing will be done from the actual weight. Adjustments will be made accordingly.
- Save by combining shipments. A minimum charge applies for each shipment under 200 lbs.
- Make sure that a Bill of Lading is filled out completely for each shipment.
- Confirm that your driver has the correct dates and times that your shipment needs to be delivered and picked up.
- Use provided shipping labels to make sure show name, booth number and other vital information is provided.

Shipping, Drayage and Material Handling: <http://e.ges.com/051600379/shippinghandling/esm>

Dot Your I's and Cross Your T's

Please be aware that a valid credit card is required for all forms of payment. We require your credit card charge authorization to be on file with GES even if you are paying by check or wire transfer.

- Make sure your credit card information is complete and correct, including the expiration date.
- Review GES Payment Policy and the Terms and Conditions of Contract
- Clearly indicate when paying by check. All check payments should be returned to:

Global Experience Specialists, Inc. (GES)
Bank of America
P.O. Box 96174
Chicago, IL 60693

Bank ACH/wire transfer payment information

Beneficiary:	Global Experience Specialists	If requested, following is the physical address for routing identifiers: Bank of America, Wire Transfer-Customer Services 2000 Clayton Road Concord, CA 94520 USA
c/o Bank of America	(GES)	
901 Main Street,	Account #: 7188101819	
TX1-492-07-14	Wire ABA Routing #: 026009593	
Dallas, TX 75202-3714 USA	ACH ABA Routing #: 071000039	
Telephone # 702-263-2795 or 702-914-5112	SWIFT Address: BOFAUS3N CHIPS Address: 0959	

For ACH/Wire Transfer send the following information to GES via email to Cash Application Team at cashapplication@ges.com.

- Exhibiting company name, show name, show facility
- Date and amount of wire transfer
- Bank and country where transfer originated

G-10 010617 040417 051600379

No Tipping Required

GES work rules prohibit the solicitation or acceptance of tips in cash, products or gifts of any kind by any employee. Our employees are paid appropriate wages denoting professional status; therefore, tipping of any kind is not allowed.

Where Did My Crates Go?

After your exhibit is set-up and your products displayed, you must place "empty" stickers on your empty containers for storage during the show. At show site a kiosk with a floor plan and color coded "empty" stickers will be available. Crews will clear the floor of all "empty" stickered containers to clear room for other freight.

- Simply write your booth number, company and show name on the sticker and place the container in the aisle. It will be stored throughout the exposition and then returned to your booth upon show close.
- Place stickers on all 4 sides of the crate.
- Please label your empty containers as soon as possible to keep your area clear and make it easier to prepare your booth.

Don't Forget to Take Out the Trash

Exhibitors planning on disposing of booth properties and/or floor covering at the end of the show should pre-order this service. In the event that excessive booth properties and/or floor covering are abandoned/left on the floor at the conclusion of a move-out, a dumpster fee will be billed to the exhibiting company.

Keeping Up Appearances

Pay close attention to your booth size when ordering items based on booth sq. footage or quantity of decorating items. Please do not order more than what will comfortably fit in your space.

- Exhibitors that order two (2) – standard pre-cut carpet pieces should keep in mind that there will be a visible seam where the pieces of carpet are placed together. GES cannot guarantee that carpet colors will be an exact match due to dye lot differences.
- Order just enough carpet to fit your standard booth space. A 10' x 10' booth should not order 10' x 20' carpet.
- We custom cut carpet to fit your needs.

It's All About the Padding

Ordering carpet for your booth? Think about what kind padding you need if you are going to be on your feet all day. That little extra cushion can make all the difference at the end of the day.

Carpet and Padding: <http://e.ges.com/051600379/carpet/esm>

What Goes Up Must Come Down

If labor is needed for your booth space at the time of move-in, you will also need labor for move-out. Remember, what you put up must be taken down.

- See Labor Information form for rules specific to the show. Work rules can vary based on show location.
- Gratuities in any form, including cash, gifts, or labor hours for work not actually performed are prohibited by GES.
- All rates are subject to change if necessitated by increased labor and material costs.
- Pre-order labor to save.

Labor Services: <http://e.ges.com/051600379/LaborandEquipment/esm>

Domestic Third Party Billing Request

All orders are governed by the GES Payment Policy and GES Terms & Conditions of Contract as specified in this Exhibitor Services Manual.

Forest Products Machinery & Equipment Exposition
 Georgia World Congress Center
 June 14 - 16, 2017

Form Deadline Date:
 May 22, 2017

Company Name _____ Email _____ Phone Number _____ Booth Number _____

Return this form when a third party (any party other than exhibiting company) ("AGENT") should be billed for services.

Step 1. Provide the Exhibiting Company contact information and signature

Exhibiting Company Name _____

Exhibiting Company Address _____ City _____ State _____ Zip/Country _____

Phone _____ Fax _____ Contact's Email Address _____

Please Sign _____
 Exhibiting Company Authorized Signature

_____ Date _____
 Exhibiting Company Authorized Name - Please Print

I agree in placing this order that I have accepted GES Payment Policy and GES Terms & Conditions of Contract, including authorization for GES to retain personal information to better serve my need for GES services at future events.

Step 2. Check services below to invoice to the Third Party

All Services If the Third Party is not to be invoiced for "All Services" please select specific services below. Exhibitor will need to complete Payment and Credit Card Authorization and submit with this form if third party is not to be invoiced for all services.

Booth Cleaning Exhibit Systems GES Logistics I & D Labor Forklift Labor Material Handling
 Rental Carpet Rental Furniture Signs
 Other (Please Specify) _____

Step 3. Provide the Third Party contact information

Third Party Company Name _____

Third Party Company Address _____ City _____ State _____ Zip/Country _____

Phone _____ Fax _____ Contact's Email Address _____

Step 4. Complete Third Party Credit Card Charge Authorization with signature

Cardholder Name - Please Print _____

Billing Address _____ City _____ State _____ Zip/Country _____

Account Number _____ Expiration Date _____
 MasterCard Corporate Card
 VISA Personal Card
 American Express

Please Sign _____
 Third Party Cardholder's Signature

_____ Date _____
 Third Party Cardholder's Name - Please Print

I agree in placing this order that I have accepted GES Payment Policy and GES Terms & Conditions of Contract, including authorization for GES to retain personal information to better serve my need for GES services at future events.

GES reserves the right to deny any Third Party Billing Request that is not complete or received by the deadline date. **It is understood and agreed that the Exhibiting Company is ultimately responsible for payment of charges for services requested by Exhibiting Company or its Agents, and for all acts and/or omissions of its Agents.** If an Agent does not pay the invoice before the last day of the show, charges will revert to the Exhibiting Company. All Invoices are due and payable upon receipt. GES Terms & Conditions of Contract, and GES' Payment Policy apply to both the Exhibiting Company and all Agents. We require your complete credit card information even if you are paying by check or bank wire transfer.

Review and Return: Return to Fax: 866.329.1437 • International Fax: 702.263.1520

051600379
040417
G-3 012417

Carpet

Standard

13 oz. is conventional filament nylon carpet that is re-used for pre-cut sizes and new for custom-cut orders.

Includes:

- 13 oz. 100% recyclable color options include  Blue Jay, Pepper, and Black.
- Custom Cut includes 4 mil poly covering
- Available in pre-cut sizes
- Installation and pick-up at the close of the show
- Front edge taping



Black (41) 



Blue (42)

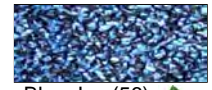

Blue Jay (56) 



Gray (40)

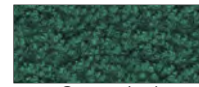

Green (45)

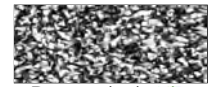

Pepper (52) 



Red (49)

Plush

26 oz. premium carpet is 100% recyclable. Same industry tradeshow performance standards as conventional carpet, but helps to reduce the volume of excess materials from entering landfills.

Includes:

- 26 oz. 100% recyclable carpet 
- 4 mil poly covering for protection
- Anti-static treatment
- 3M Scotchgard™ protection
- Installation and pick-up at the close of the show
- Front edge taping

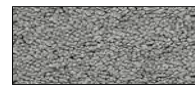

Cement (70)



Charcoal (71)

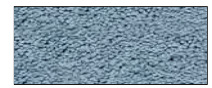

Cobalt (72)

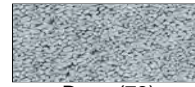

Dove (73)

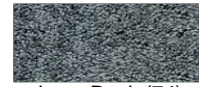

Lava Rock (74)

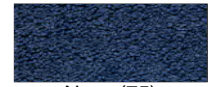

Navy (75)



Onyx (76)



Red (49)

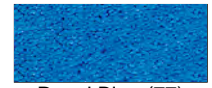

Royal Blue (77)

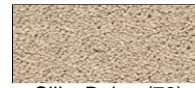

Silky Beige (78)

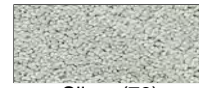

Silver (79)



Snow (80)

Ultra Plush

50 oz. premium carpet is 100% recyclable. Same industry tradeshow performance standards as conventional carpet, but helps to reduce the volume of excess materials from entering landfills.

Includes:

- 50 oz. 100% recyclable carpet 
- 4 mil poly covering for protection
- Anti-static treatment
- 3M Scotchgard™ protection
- Installation and pick-up at the close of the show
- Front edge taping



Bisque (81)



Black (41)



Cabernet (82)



Graphite (83)



Iceberg (84)



Midnight (85)



Seascape (86)

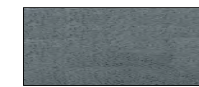

Sterling (87)



Teal (55)

 The leaf symbol indicates recyclable or eco-friendly materials, per manufacturer's specifications.

Colors may vary due to facility lighting, printing limitations and dye lot differences. Some items may not be available at all locations. See order form for details. Styles of items portrayed on this brochure may vary in some locations.

Carpet Order Form

All orders are governed by the GES Payment Policy and GES Terms & Conditions of Contract as specified in this Exhibitor Services Manual.

Forest Products Machinery & Equipment Exposition
 Georgia World Congress Center
 June 14 - 16, 2017

Discount Deadline Date:
 May 22, 2017

Company Name _____ Email _____ Phone Number _____ Booth Number _____

***Black 13 oz. Standard Carpet is included with all exhibits.**



Easy Ordering Tips:

- All prices include delivery, rental, and removal.
- Return your orders three (3) weeks before show move-in to ensure availability. At show site color options and grades may not be available and substitutions might be necessary.
- Do you have a booth larger than 300 sq. ft., an island or peninsula? Order Custom-Cut carpet! (Minimum 100 sq. ft. order required.)

Carpet

13 oz. Color Options

(Gray will be provided if no color is indicated below)

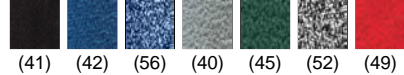

26 oz. Plush Color Options

(Dove will be provided if no color is indicated below)

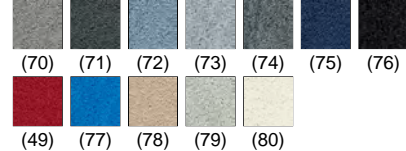

50 oz. Ultra Plush Color Options

(Iceberg will be provided if no color is indicated below)



Item Code	Description	Color Code	Discount (\$)	Regular (\$)	Qty	Tax %	Total
5001	Pre-Cut 13 oz. Standard Carpet 10'x10'		209.00	291.00		8.9	\$
5002	Pre-Cut 13 oz. Standard Carpet 10'x20'		408.00	567.00		8.9	\$
5003	Pre-Cut 13 oz. Standard Carpet 10'x30'		632.00	878.00		8.9	\$

Calculate Sq. Ft. = Width _____ X Length _____ = _____ Total Sq. Ft.

Item Code	Description	Color Code	Discount (\$)	Regular (\$)	Sq. Ft.	Tax %	Total
5000	13 oz. Carpet Custom-Cut, Per Sq.Ft.		3.74	5.20		8.9	\$
5006	26 oz. Plush Carpet Custom-Cut, Per Sq.Ft.		5.25	7.30		8.9	\$
5007	50 oz. Ultra Plush Carpet Custom-Cut, Per Sq.Ft.		6.25	8.70		8.9	\$

Item Code	Description	Discount (\$)	Regular (\$)	Sq. Ft.	Tax %	Total
500400	Carpet Padding, 1/2" Thick, Per Sq.Ft.	1.92	2.67		8.9	\$

Item Code	Description	Discount (\$)	Regular (\$)	Sq. Ft.	Tax %	Total
500410	Carpet Plastic Covering, Per Sq.Ft.	0.77	1.07		8.9	\$

Electrical or Utilities Under Carpet?

Yes No

Total and Sign: Return to Fax: 866.329.1437 • International Fax: 702.263.1520

Please Sign

X

Authorized Signature

Authorized Name - Please Print

Date

I agree in placing this order that I have accepted GES Payment Policy and GES Terms & Conditions of Contract, including authorization for GES to retain personal information to better serve my need for GES services at future events.

Total Payment Enclosed

\$

Cancellation Policy: Custom Size Booth Carpet cancelled after being cut will be charged **100%**. All other carpet cancelled will be charged 50% of original price after move-in begins and **100%** of original price after installation.

051600379

040417

C-1 031017



Carpet Package Order Form

All orders are governed by the GES Payment Policy and GES Terms & Conditions of Contract as specified in this Exhibitor Services Manual.

Forest Products Machinery & Equipment Exposition
 Georgia World Congress Center
 June 14 - 16, 2017

Discount Deadline Date:
 May 22, 2017

Company Name _____ Email _____ Phone Number _____ Booth Number _____

***Black 13 oz. Standard Carpet is included with all exhibits.**



Easy Ordering Tips:

- All prices include delivery, rental, and removal.
- Return your orders three (3) weeks before show move-in to ensure availability. At show site some colors and grades may not be available and substitutions might be necessary.
- A minimum of 100 sq. ft. is required for all custom-cut carpet package orders.

Carpet Packages

13 oz. Color Options

(Gray will be provided if no color is indicated below)

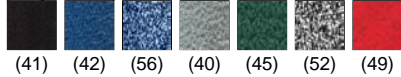

26 oz. Plush Color Options

(Dove will be provided if no color is indicated below)

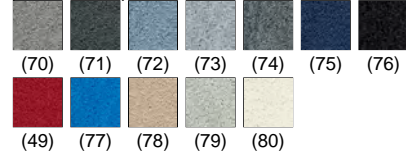

50 oz. Ultra Plush Color Options

(Iceberg will be provided if no color is indicated below)

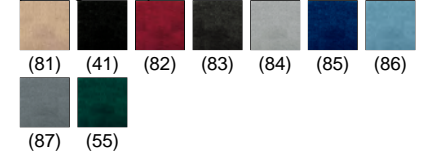

Item Code	Description	Color Code	Discount (\$)	Regular (\$)	Sq. Ft.	Tax %	Total
400021	13 oz. Carpet Package, Per Sq.Ft.		6.53	9.08		8.9	\$
	↳ Includes 10% Off: 13 oz. Standard Custom-Cut Carpet, Padding, Visqueen and 3 Day(s) Cleaning.						
400022	26 oz. Plush Carpet Package, Per Sq.Ft.		7.88	10.97		8.9	\$
	↳ Includes 10% Off: 26 oz. Plush Custom-Cut Carpet, Padding, Visqueen, and 3 Day(s) Cleaning.						
400023	50 oz. Ultra Plush Carpet Package, Per Sq.Ft.		8.78	12.23		8.9	\$
	↳ Includes 10% Off: 50 oz. Ultra Plush Custom-Cut Carpet, Padding, Visqueen, and 3 Day(s) of Cleaning.						

Electrical or Utilities Under Carpet?

Yes No



- Save money by pre-ordering labor for installation for stairs, platforms, risers or meeting rooms.
- Return your orders before the discount deadline to receive the best price.

Total and Sign: Return to Fax: 866.329.1437 • International Fax: 702.263.1520

Please Sign _____
 Authorized Signature

 Authorized Name - Please Print

 Date

I agree in placing this order that I have accepted GES Payment Policy and GES Terms & Conditions of Contract, including authorization for GES to retain personal information to better serve my need for GES services at future events.

Total Payment Enclosed \$ _____

Cancellation Policy: Custom Size Booth Carpet cancelled after being cut will be charged **100%**. All other carpet cancelled will be charged **50%** of original price after move-in begins and **100%** of original price after installation.

051600379

040417

C-2 030917

Furniture and Accessories

Chairs



300051 - Chair, Contemporary Arm, 23"W 18"D 31"H



300052 - Chair, Contemporary Side, 19.5"W 18"D 31"H



300050 - Chair, Plastic Contour, 18"W 18.5"D 32"H



300053 - Stool, Contemporary, 17"W 18"D 48"H

Tables



300057 - Table, Rectangle, 24"x36"x30" High



300056 - Table, Square, 24"x24"x30" High



300059 - Table, Starbase, 30" Diameter x 40" High



300058 - Table, Starbase, 40" Diameter x 30" High

Skirted Tables



3004 - Table 4', Skirted 4 Sides, 24" x 30" High



3006 - Table 6', Skirted 3 Sides, 24" x 30" High

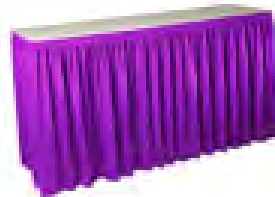

3008 - Table 8', Skirted 3 Sides, 24" x 30" High

Table Skirt Colors



Beige (54)



Black (41)



Blue (42)

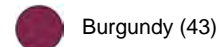

Burgundy (43)



Gold (46)



Gray (40)

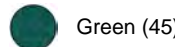

Green (45)

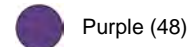

Purple (48)



Red (49)

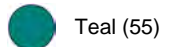

Teal (55)

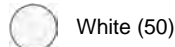

White (50)

Colors may vary due to facility lighting, printing limitations and dye lot differences. Some items may not be available at all locations. See order form for details. Styles of items portrayed on this brochure may vary in some locations.

Furniture and Accessories

Display Furniture



Full View



Half View



Quarter View



Vertical

Accessories



300124 - Aisle Stanchion Chain, Plastic, Per Foot



300123 - Aisle Stanchion, without Chain



300103 - Aluminum Easel



300111 - Bag Stand



300102 - Coat Rack



300104 - Garment Rack



300106 - Literature Rack



300201 - Pegboard, White, 4'x8'



305182 - Refrigerator, White, 20"L 22"D 33"H



300120 - Sign Holder, Bell Base



300108 - Sign Holder, Chrome, 22"x28"



300211 - Tackboard, 4'x8'



300112 - Ticket Tumbler, Small, Table Top



300113 - Wastebasket



300118 - Waterfall Stand

Colors may vary due to facility lighting, printing limitations and dye lot differences. Some items may not be available at all locations. See order form for details. Styles of items portrayed on this brochure may vary in some locations.

Furniture and Accessories Order Form

All orders are governed by the GES Payment Policy and GES Terms & Conditions of Contract as specified in this Exhibitor Services Manual.

Forest Products Machinery & Equipment Exposition
Georgia World Congress Center
June 14 - 16, 2017

Discount Deadline Date:
May 22, 2017

Company Name _____ Email _____ Phone Number _____ Booth Number _____



Easy Ordering Tips:

- All prices include delivery, rental, and removal.
- Return your orders three (3) weeks before show move-in to ensure availability. At show site some items may not be available and substitutions might be necessary.
- Enjoy a fast and easy ordering experience online with Expresso:
<http://e.ges.com/051600379/furnishings/esm>

Furniture and Accessories

Skirt and Drape Color Options

(Gray will be provided if no color is indicated below)



Chairs

Item Code	Description	Discount (\$)	Regular (\$)	Qty	Tax %	Total
300051	Chair, Contemporary Arm, 23"W 18"D 31"H	139.00	193.00		8.9	\$
300052	Chair, Contemporary Side, 19.5"W 18"D 31"H	121.00	168.00		8.9	\$
300050	Chair, Plastic Contour, 18"W 18.5"D 32"H	74.75	104.00		8.9	\$
300053	Stool, Contemporary, 17"W 18"D 48"H	164.00	228.00		8.9	\$

Tables

Item Code	Description	Discount (\$)	Regular (\$)	Qty	Tax %	Total
300057	Table, Rectangle, 24"x36"x30" High	124.00	173.00		8.9	\$
300056	Table, Square, 24"x24"x30" High	114.00	159.00		8.9	\$
300059	Table, Starbase, 30" Diameter x 40" High	270.00	375.00		8.9	\$
300058	Table, Starbase, 40" Diameter x 30" High	270.00	375.00		8.9	\$

Skirted Tables

Item Code	Description	Color Code	Discount (\$)	Regular (\$)	Qty	Tax %	Total
3004	Table 4', Skirted 4 Sides, 24" x 30" High		142.00	197.00		8.9	\$
3006	Table 6', Skirted 3 Sides, 24" x 30" High		174.00	242.00		8.9	\$
3008	Table 8', Skirted 3 Sides, 24" x 30" High		202.00	281.00		8.9	\$
3007	Table, Skirt 4th Side		45.75	63.50		8.9	\$

Select size: 6' Table _____ 8' Table _____

Unskirted Tables

Item Code	Description	Discount (\$)	Regular (\$)	Qty	Tax %	Total
300400	Table 4', Unskirted, 24" x 30" High	115.00	160.00		8.9	\$
300600	Table 6', Unskirted, 24" x 30" High	137.00	191.00		8.9	\$
300800	Table 8', Unskirted, 24" x 30" High	162.00	225.00		8.9	\$

Skirted Counters

Item Code	Description	Color Code	Discount (\$)	Regular (\$)	Qty	Tax %	Total
3014	Counter 4', Skirted 4 Sides, 24" x 42" High		183.00	254.00		8.9	\$
3016	Counter 6', Skirted 3 Sides, 24" x 42" High		220.00	306.00		8.9	\$
3018	Counter 8', Skirted 3 Sides, 24" x 42" High		250.00	348.00		8.9	\$

A-1 010317 040417 051600379

Form Continues on Next Page

17



Furniture and Accessories Order Form

All orders are governed by the GES Payment Policy and GES Terms & Conditions of Contract as specified in this Exhibitor Services Manual.

Discount Deadline Date:
May 22, 2017

Company Name _____ Email _____ Phone Number _____ Booth Number _____

3017	Counter, Skirt 4th Side		56.75	78.75		8.9	\$
 Select size: 6' Counter _____ 8' Counter _____							

Unskirted Counter

Item Code	Description	Discount (\$)	Regular (\$)	Qty	Tax %	Total
301400	Counter 4', Unskirted, 24" x 42" High	147.00	205.00		8.9	\$
301600	Counter 6', Unskirted, 24" x 42" High	178.00	247.00		8.9	\$
301800	Counter 8', Unskirted, 24" x 42" High	200.00	278.00		8.9	\$

Risers

Item Code	Description	Discount (\$)	Regular (\$)	Qty	Tax %	Total
300193	Riser 4', Double Tier, 48"x8"x16" High	66.25	92.25		8.9	\$
300191	Riser 4', Single Tier, 48"x8"x8" High	46.25	64.25		8.9	\$
300194	Riser 6', Double Tier, 72"x8"x16" High	85.50	119.00		8.9	\$
300192	Riser 6', Single Tier, 72"x8"x8" High	66.25	92.25		8.9	\$

Custom Booth Drape

Item Code	Description	Color Code	Discount (\$)	Regular (\$)	Qty	Tax %	Total
3001	Drape, 3' High, Per Foot, 4' Minimum		19.40	27.00		8.9	\$
3002	Drape, 8' High, Per Foot, 4' Minimum		24.10	33.50		8.9	\$

Display Furniture

Item Code	Description	Discount (\$)	Regular (\$)	Qty	Tax %	Total
300073	Display Case 4', Corner View	676.00	939.00		8.9	\$
300074	Display Case 4', Full View	656.00	912.00		8.9	\$
300075	Display Case 4', Half View	656.00	912.00		8.9	\$
300076	Display Case 4', Quarter View	656.00	912.00		8.9	\$
300078	Display Case 5', Full View	676.00	939.00		8.9	\$
300079	Display Case 5', Half View	676.00	939.00		8.9	\$
300080	Display Case 5', Quarter View	676.00	939.00		8.9	\$
300082	Display Case 6', Full View	695.00	966.00		8.9	\$
300083	Display Case 6', Half View	695.00	966.00		8.9	\$
300084	Display Case 6', Quarter View	695.00	966.00		8.9	\$
300088	Display Case 7', Vertical	906.00	1,260.00		8.9	\$

Accessories

Item Code	Description	Discount (\$)	Regular (\$)	Qty	Tax %	Total
300124	Aisle Stanchion Chain, Plastic, Per Foot	5.60	7.80		8.9	\$
300127	Aisle Stanchion, Tensa	87.00	121.00		8.9	\$
300123	Aisle Stanchion, without Chain	56.75	78.75		8.9	\$
300103	Aluminum Easel	74.75	104.00		8.9	\$
300111	Bag Stand	102.00	142.00		8.9	\$
300102	Coat Rack	104.00	145.00		8.9	\$
300104	Garment Rack	104.00	145.00		8.9	\$
300106	Literature Rack	203.00	282.00		8.9	\$
300201	Pegboard, White, 4'x8'	177.00	246.00		8.9	\$

 Select alignment: Horizontal _____ Vertical _____

A-1 010317 040417 051600379



Furniture and Accessories Order Form

All orders are governed by the GES Payment Policy and GES Terms & Conditions of Contract as specified in this Exhibitor Services Manual.

Discount Deadline Date:
May 22, 2017

Company Name _____ Email _____ Phone Number _____ Booth Number _____

Accessories

305182	Refrigerator, White, 20"L 22"D 33"H	381.00	530.00		8.9	\$
300131	Security Cage, Large, without Lock	578.00	804.00		8.9	\$
300132	Security Cage, Small, without Lock	386.00	537.00		8.9	\$
300120	Sign Holder, Bell Base	95.75	133.00		8.9	\$
300108	Sign Holder, Chrome, 22"x28"	95.75	133.00		8.9	\$
300211	Tackboard, 4'x8'	191.00	265.00		8.9	\$
 Select alignment: Horizontal _____ Vertical _____						
300112	Ticket Tumbler, Small, Table Top	164.00	228.00		8.9	\$
300113	Wastebasket	23.55	32.75		8.9	\$
300118	Waterfall Stand	104.00	145.00		8.9	\$

Electrical Outlets Not Included

Need power for that lamp, display case, or refrigerator in your booth? Order electrical outlets separately for your booth space through the electrical service provider.

Total and Sign: Return to Fax: 866.329.1437 • International Fax: 702.263.1520

Please Sign _____
Authorized Signature

Authorized Name - Please Print

Date

I agree in placing this order that I have accepted GES Payment Policy and GES Terms & Conditions of Contract, including authorization for GES to retain personal information to better serve my need for GES services at future events.

Total Payment Enclosed

Cancellation Policy: Items cancelled will be charged **50%** of original price after move-in begins and **100%** of original price after installation.

040417 051600379

A-1 010317

Furniture Package Order Form

All orders are governed by the GES Payment Policy and GES Terms & Conditions of Contract as specified in this Exhibitor Services Manual.

Forest Products Machinery & Equipment Exposition
 Georgia World Congress Center
 June 14 - 16, 2017

Discount Deadline Date:
 May 22, 2017

Company Name _____ Email _____ Phone Number _____ Booth Number _____



Easy Ordering Tips:

- Furniture Packages offer significant savings and convenience.
- All prices include delivery, rental, and removal.
- Return your orders three (3) weeks before show move-in to ensure availability. At show site some items may not be available and substitutions might be necessary.

Furniture Package



Furniture Package 1

Item Code	Description	Color Code	Discount (\$)	Regular (\$)	Qty	Tax %	Total
4906	Furniture Package 1		312.35	434.48		8.9	\$
↳ Includes 10% Off: (2) Plastic Contour Chairs, (1) 6' Skirted Table 24"X30", (1) Wastebasket.							

Skirt Color Options

(Gray will be provided if no color is indicated.)



Furniture Package 2

Item Code	Description	Discount (\$)	Regular (\$)	Qty	Tax %	Total
490012	Furniture Package 2	764.60	1,061.78		8.9	\$
↳ Includes 10% Off: (4) Contemporary Arm Chairs, (1) Starbase Table 40"X30", (1) Wastebasket.						

Total and Sign: Return to Fax: 866.329.1437 • International Fax: 702.263.1520

Please Sign

X

Authorized Signature

Authorized Name - Please Print

Date

I agree in placing this order that I have accepted GES Payment Policy and GES Terms & Conditions of Contract, including authorization for GES to retain personal information to better serve my need for GES services at future events.

Total Payment Enclosed

\$

Cancellation Policy: Items cancelled will be charged **50%** of original price after move-in begins and **100%** of original price after installation.

040417 051600379

A-2 031017

Specialty Furniture

Seating - Sofas and Loveseats



305321 - Key Largo Loveseat, Black Fabric, 57"L 35"D 34"H



305322 - Key Largo Sofa, Black Fabric, 79"L 35"D 34"H



305262 - Loveseat, Naples, Black Vinyl, 62"L 30"D 28"H



305364 - Naples Loveseat, Powered Black Vinyl, 62"L 30"D 28"H



305362 - Naples Sofa, Powered Black Vinyl, 87"L 30"D 28"H



305217 - Roma Sofa, Powered White Vinyl, 78"L 31"D 33"H



305264 - Sectional, Heathrow, Black Vinyl, 72"L 48"D 28"H



305120 - Sectional, South Beach, 3 pc., Platinum, 152"L 40"D 33"H



305236 - Sofa, Allegro, Blue Fabric, 73"L 34.5"D 29.5"H



305265 - Sofa, Heathrow, Black Vinyl, 48"L 24"D 28"H



305261 - Sofa, Naples, Black Vinyl, 87"L 30"D 28"H



305221 - Sofa, Roma, White Vinyl, 78"L 31"D 33"H



305119 - Sofa, South Beach, Platinum Suede, 69"L 29"D 33"H



305268 - Sofa, Tangiers, 78"L 37"D 36"H

Colors may vary due to facility lighting, printing limitations and dye lot differences. Some items may not be available at all locations. See order form for details. Styles of items portrayed on this brochure may vary in some locations.

Specialty Furniture

Seating - Club Chairs



305235 - Chair, Allegro, Blue Fabric, 36"L 34.5"D 29.5"H



305072 - Chair, Barcelona, Black, 30"L 31"D 35"H



305073 - Chair, Barcelona, White, 30"L 30"D 31"H



305266 - Chair, Heathrow, Black Vinyl, 24"L 24"D 28"H



305263 - Chair, Naples, Black Vinyl, 36"L 30"D 28"H



305220 - Chair, Roma, White Vinyl, 37"L 31"D 33"H



305269 - Chair, Tangiers, 34"L 37"D 36"H



305070 - Chair, Tub, Key West, Black, 31"L 31"D 31"H



305267 - Corner, Heathrow, Black Vinyl, 24"L 24"D 28"H



305320 - Key Largo Chair, Black Fabric, 35"L 35"D 34"H



305363 - Naples Chair, Powered Black Vinyl, 36"L 30"D 28"H



305222 - Roma Chair, Powered White Vinyl, 37"L 31"D 33"H

Seating - Chairs



305152 - Chair, Altura, Guest, 25"L 20"D 34"H



305041 - Chair, Berlin, Black/White, 18"L 22"D 32"H



305042 - Chair, Berlin, Red/White, 18"L 22"D 32"H



305110 - Chair, Brewer, Black, 20"L 20"D 32"H



305260 - Chair, Christopher, White Vinyl w/Chrome, 17"L 19"D 35"H



305285 - Chair, Duet Stack, Black/Chrome, 23"L 18.5"D 16"H



305232 - Chair, Fusion, Red/White, 19"L 21"D 32"H



305079 - Chair, Ice Transparent/Chrome, 17.25"L 20"D 32"H



305271 - Chair, La Brea Swivel, Charcoal Gray Fabric, 35"L 27"D 40"D



305149 - Chair, Luxor, Guest, 27"L 28"D 40"H



305270 - Chair, Madden Arm, Lt. Gray Vinyl, 27"L 32"D 33"H



305284 - Chair, Rustique Arm, Gunmetal, 20"L 18"D 31"H



305272 - Chair, Swanson Swivel, White Vinyl, 28"L 25"D 18"H



305250 - Chair, Wendy, Clear Acrylic, 15"L 20"D 36"H



305442 - Laguna Chair, 18"L 19"D 34"H



305420 - Malba Chair, Gray, 20"L 20"D 32"H



305421 - Malba Chair, Green, 20"L 20"D 32"H



305441 - Zenith Chair, 19"L 22"D 32"H

Colors may vary due to facility lighting, printing limitations and dye lot differences. Some items may not be available at all locations. See order form for details. Styles of items portrayed on this brochure may vary in some locations.

Specialty Furniture

Seating - Ottomans



305096 - Endless Curved Ottoman, Black, 60.5"L 37.5"D 15"H



305097 - Endless Curved Ottoman, White, 60.5"L 37.5"D 15"H



305277 - Ottoman, Bench, Black Vinyl, 60"L 20"D 18"H



305278 - Ottoman, Bench, White Vinyl, 60"L 20"D 18"H



305092 - Ottoman, South Beach, Wedge, Platinum, 25"L 31"D 18"H



305280 - Ottoman, Square Seat, Black, 34"L 34"D 15"H



305279 - Ottoman, Square Seat, White, 34"L 34"D 15"H



305251 - Ottoman, Vibe Cube, Black, 18"L 18"D 18"H



305246 - Ottoman, Vibe Cube, Blue, Vinyl, 18"L 18"D 18"H



305242 - Ottoman, Vibe Cube, Champagne, Vinyl, 18"L 18"D 18"H



305243 - Ottoman, Vibe Cube, Gold/Bronze, Vinyl, 18"L 18"D 18"H



305241 - Ottoman, Vibe Cube, Green, Vinyl, 18"L 18"D 18"H



305244 - Ottoman, Vibe Cube, Pink, Vinyl, 18"L 18"D 18"H



305245 - Ottoman, Vibe Cube, Red, Vinyl, 18"L 18"D 18"H



305247 - Ottoman, Vibe Cube, Yellow, Vinyl, 18"L 18"D 18"H

Seating - Office and Utility Seating



305126 - Chair, Altura Task, 25"L 26"D 21"H



305305 - Chair, Executive, Pro, White, 27.5"L 27.5"D 45.7"H



305147 - Chair, Luxor, High Back, 27"L 28"D 47"H Adj.



305148 - Chair, Luxor, Med. Back, 27"L 28"D 41"H Adj.



305309 - Meeting Chair, White Vinyl, 25.5"L 23.5"D 34"H



305307 - Pro Executive Mid Back Chair, Black Vinyl, 24"L 22"D 40"H



305308 - Pro Executive Mid Back Chair, White, 24"L 22"D 40"H

Colors may vary due to facility lighting, printing limitations and dye lot differences. Some items may not be available at all locations. See order form for details. Styles of items portrayed on this brochure may vary in some locations.

Specialty Furniture

Seating - Barstools



305370 - Apex Barstool, Black Vinyl, 21"L 21"D 33"H



305371 - Apex Barstool, Blue Ultra Suede, 21"L 21"D 33"H



305372 - Apex Barstool, Red Vinyl, 21"L 21"D 33"H



305373 - Apex Barstool, White Vinyl, 21"L 21"D 33"H



305012 - Barstool, Banana, Black, 21"L 22"D 30"H



305013 - Barstool, Banana, White, 21"L 22"D 30"H



305010 - Barstool, Gin, Maple, 16"L 16"D 29"H



305023 - Barstool, Ice, Transparent/Chrome, 16.75"L 16"D 32"H



305289 - Barstool, Lift, Chrome/Black Seat, 15" Round 23-33.5"H



305292 - Barstool, Lift, Chrome/Gray Seat, 15" Round 23-33.5"H



305291 - Barstool, Lift, Chrome/Red Seat, 15" Round 23-33.5"H



305290 - Barstool, Lift, Chrome/White Seat, 15" Round 23-33.5"H



305009 - Barstool, Oslo, Blue, 17"L 20"D 30"H



305008 - Barstool, Oslo, White, 17"L 20"D 30"H



305288 - Barstool, Rustique, Gunmetal, 13"L 13"D 30"D



305206 - Barstool, Shark Swivel, White/Chrome Base, 22"L 19"D 34"-44"H



305207 - Barstool, Zooey Swivel, White/Chrome Base, 15"Lx17"Dx31"-35"H



305259 - Christopher Barstool, 19"L 15"D 41"H



305440 - Zenith Barstool, 19"L 20"D 44"H

Table Surface Colors



Maple



Graphite Nebula



Brushed Red

Tables - Cafe



305426 - Cafe Table/Hydraulic Chrome Base, Liquid Steel Blue, 30"RND 29"



305428 - Café Table/Black Base, Liquid Steel Blue, 30"RND 29"H



305067 - G30 Cafe Table, Powered White Top, 72"L 26"D 30"H



305429 - Madison Cafe Table/Hydraulic Base, 30"RND 29"H



305153 - Table, Cafe, Brushed Red/Hydraulic Chrome Base, 30" Round 29"H



305164 - Table, Cafe, Graphite/Black, 30" Round 29"H



305167 - Table, Cafe, Graphite/Black, 36" Round 29"H



305156 - Table, Cafe, Graphite/Hydraulic Chrome Base, 30" Round 29"H

Colors may vary due to facility lighting, printing limitations and dye lot differences. Some items may not be available at all locations. See order form for details. Styles of items portrayed on this brochure may vary in some locations.

Specialty Furniture



305159 - Table, Cafe, Graphite/ Hydraulic Chrome Base, 36" Round 29"H



305165 - Table, Cafe, Maple/ Black, 30" Round 29"H



305168 - Table, Cafe, Maple/ Black, 36" Round 29"H



305157 - Table, Cafe, Maple/ Hydraulic Chomr Base, 30" Round 29"H



305160 - Table, Cafe, Maple/ Hydraulic Chrome Base, 36" Round 29"H



305161 - Table, Cafe, Red/ Black, 30" Round 29"H



305282 - Table, Cafe, Silver Texture/Black Base, 30" Round 29"H



305299 - Table, Cafe, Silver Textured Grain/ Hydraulic Chrome Base, 30" Round 29"H



305283 - Table, Cafe, White Laminate/Black Base, 36" Round 29"H



305301 - Table, Cafe, White Laminate/ Hydraulic Chrome Base, 36" Round 29"H

Tables - Bar



305425 - Bar Table/ Hydraulic Chrome Base, Steel Blue, 30" RND 45"H



305071 - G30 Bar Table, Powered White Top, 72"L 26"D 42"H



305405 - Madison Bar Table/ Black Base, 30" RND 42"H



305139 - Table, Bar, Brushed Red/ Hydraulic Chrome Base, 30" Round 45"H



305133 - Table, Bar, Graphite/ Black, 30" Round 42"H



305136 - Table, Bar, Graphite/ Black, 36" Round 42"H



305142 - Table, Bar, Graphite/ Hydraulic Chrome Base, 30" Round 45"H



305145 - Table, Bar, Graphite/ Hydraulic Chrome Base, 36" Round 45"H



305134 - Table, Bar, Maple/ Black, 30" Round 42"H



305137 - Table, Bar, Maple/ Black, 36" Round 42"H



305143 - Table, Bar, Maple/ Hydraulic Chrome Base, 30" Round 45"H



305146 - Table, Bar, Maple/ Hydraulic Chrome Base, 36" Round 45"H



305130 - Table, Bar, Red/ Black, 30" Round 42"H



305286 - Table, Bar, Silver Textured Grain/ Black Base, 30" Round 42"H



305302 - Table, Bar, Silver Textured Grain/ Hydraulic Chrome Base, 30" Round 45"H



305287 - Table, Bar, White Laminate/ Black Base, 36" Round 42"H



305303 - Table, Bar, White Laminate/ Hydraulic Chrome Base, 36" Round 45"H

Colors may vary due to facility lighting, printing limitations and dye lot differences. Some items may not be available at all locations. See order form for details. Styles of items portrayed on this brochure may vary in some locations.

Specialty Furniture

Tables - Cocktail



305430 - Alondra Cocktail Table, Glass, 47"L 24"D 16"H



305189 - G30 Cocktail Table, Powered White Top, 72"L 26"D 18"H



305435 - Geo Cocktail Table, Wood, 47"L 24"D 17"H



305188 - Sydney Powered Cocktail Table, Black, 48"L 26"D 18"H



305187 - Sydney Powered Cocktail Table, White, 48"L 26"D 18"H



305014 - Table, Cocktail, Geo, Chrome, 50"L 22"D 16"H



305210 - Table, Cocktail, Oliver, 47"L 27"D 19"H



305016 - Table, Cocktail, Silverado, 36" Round 17"H



305025 - Table, Cocktail, Sydney Black, 48"L 26"D 18"H



305024 - Table, Cocktail, Sydney White, 48"L 26"D 18"H

Tables - End Tables



305431 - Alondra End Table, Glass, 20"L 20"D 20"H



305436 - Geo End Table, Wood, 20"L 20"D 21"H



305112 - Regis End Table, 16"L 15.5"D 16.5"H



305273 - Table, Aura, White Metal, 15" Round 22"H



305274 - Table, E, Wood, 21"L 15.5"D 27.5"H



305044 - Table, End, Geo, Chrome, 26"L 26"D 20"H



305211 - Table, End, Oliver, 22" Round 22"H



305046 - Table, End, Silverado, 24" Round 22"H



305050 - Table, End, Sydney, Black, 27"L 23"D 22"H



305048 - Table, End, Sydney, White, 27"L 23"D 22"H



305276 - Table, Mosaic, Set of 3



305275 - Table, Timber, Wood, 16" Round 17"H

Colors may vary due to facility lighting, printing limitations and dye lot differences. Some items may not be available at all locations. See order form for details. Styles of items portrayed on this brochure may vary in some locations.

Specialty Furniture

Conference Tables



305402 - 10' Madison Table, 120\"/>



305400 - 5' Madison Table, 60\"/>



305401 - 8' Madison Table, 96\"/>



305410 - Madison Conference Table, 42\"/>



305190 - Powered Conference Table Module, Black, 5\"/>



305175 - Table, Conf., Geo, Black, 42\"/>



305176 - Table, Conf., Geo, Black, 60\"/>



305173 - Table, Conf., Geo, Chrome, 42\"/>



305174 - Table, Conf., Geo, Chrome, 60\"/>



305027 - Table, Conf., Graphite, 42\"/>



305028 - Table, Conf., Graphite, 72\"/>



305029 - Table, Conf., Graphite, 96\"/>



305177 - Table, Conf., Manhattan, 42\"/>



305293 - Table, Conf., Merlin, Gray Laminate/Black, 46\"/>



305281 - Table, Conf., White Laminate, 42\"/>

Colors may vary due to facility lighting, printing limitations and dye lot differences. Some items may not be available at all locations. See order form for details. Styles of items portrayed on this brochure may vary in some locations.

Specialty Furniture

Tables - Martini Bar



305004 - Table, Bar, Martini 3 pc., 100"L 100"D 47"H



305003 - Table, Bar, Martini, 50"L 50"D 47"H

Product Display



305053 - Etagere, Black, 30"L 16"D 70"H



305052 - Etagere, Pewter, 30"L 16"D 70"H



305415 - Madison Bookcase, 36"L 12"D 72"H



305297 - Pedestal, Powered Locking, Black, 24"L 24"D 30"H



305295 - Pedestal, Powered Locking, Black, 24"L 24"D 42"H



305298 - Pedestal, Powered Locking, White, 24"L 24"D 30"H



305296 - Pedestal, Powered Locking, White, 24"L 24"D 42"H

Office and Utility Furniture



305294 - Desk, Writing/Work Table, White Laminate/White, 48"L 24"D 30"H



305416 - Madison Credenza, 60"L 20"D 29"H



305417 - Madison Executive Desk, 60"L 30"D 29"H

Colors may vary due to facility lighting, printing limitations and dye lot differences. Some items may not be available at all locations. See order form for details. Styles of items portrayed on this brochure may vary in some locations.

Specialty Furniture

Lamps



305204 - Lamp, Floor,
Mason, Silver, 18" Round
55"H



305205 - Lamp, Table,
Mason, Silver, 16" Round
26"H

Accessories



305380 - Charging
Adapter, Black, 33"L



305381 - Charging
Adapter, White, 33"L

Colors may vary due to facility lighting, printing limitations and dye lot differences. Some items may not be available at all locations. See order form for details. Styles of items portrayed on this brochure may vary in some locations.

Specialty Furniture Order Form

All orders are governed by the GES Payment Policy and GES Terms & Conditions of Contract as specified in this Exhibitor Services Manual.

Forest Products Machinery & Equipment Exposition
 Georgia World Congress Center
 June 14 - 16, 2017

Discount Deadline Date:
 May 22, 2017

Company Name _____ Email _____ Phone Number _____ Booth Number _____



Easy Ordering Tips:

- All prices include delivery, rental, and removal.
- Return your orders three (3) weeks before show move-in to ensure availability. At show site some items may not be available and substitutions might be necessary.
- Enjoy a fast and easy ordering experience online with Espresso:
<http://e.ges.com/051600379/furnishings/esm>

Specialty Furniture

Link to view images: <http://ges.com/ecomm/info/B1-Brochure-CORE.pdf>

Seating - Sofas and Loveseats

Item Code	Description	Discount (\$)	Regular (\$)	Qty	Tax %	Total
305321	Key Largo Loveseat, Black Fabric, 57"L 35"D 34"H	668.00	928.00		8.9	\$
305322	Key Largo Sofa, Black Fabric, 79"L 35"D 34"H	719.00	1,000.00		8.9	\$
305262	Loveseat, Naples, Black Vinyl, 62"L 30"D 28"H	714.00	993.00		8.9	\$
305364	Naples Loveseat, Powered Black Vinyl, 62"L 30"D 28"H	1,210.00	1,680.00		8.9	\$
305362	Naples Sofa, Powered Black Vinyl, 87"L 30"D 28"H	1,370.00	1,910.00		8.9	\$
305217	Roma Sofa, Powered White Vinyl, 78"L 31"D 33"H	1,370.00	1,910.00		8.9	\$
305264	Sectional, Heathrow, Black Vinyl, 72"L 48"D 28"H	1,790.00	2,490.00		8.9	\$
305120	Sectional, South Beach, 3 pc., Platinum, 152"L 40"D 33"H	1,560.00	2,170.00		8.9	\$
305236	Sofa, Allegro, Blue Fabric, 73"L 34.5"D 29.5"H	734.00	1,020.00		8.9	\$
305265	Sofa, Heathrow, Black Vinyl, 48"L 24"D 28"H	791.00	1,100.00		8.9	\$
305261	Sofa, Naples, Black Vinyl, 87"L 30"D 28"H	856.00	1,190.00		8.9	\$
305221	Sofa, Roma, White Vinyl, 78"L 31"D 33"H	1,010.00	1,410.00		8.9	\$
305119	Sofa, South Beach, Platinum Suede, 69"L 29"D 33"H	711.00	988.00		8.9	\$
305268	Sofa, Tangiers, 78"L 37"D 36"H	734.00	1,020.00		8.9	\$

Seating - Club Chairs

Item Code	Description	Discount (\$)	Regular (\$)	Qty	Tax %	Total
305235	Chair, Allegro, Blue Fabric, 36"L 34.5"D 29.5"H	573.00	797.00		8.9	\$
305072	Chair, Barcelona, Black, 30"L 31"D 35"H	863.00	1,200.00		8.9	\$
305073	Chair, Barcelona, White, 30"L 30"D 31"H	950.00	1,320.00		8.9	\$
305266	Chair, Heathrow, Black Vinyl, 24"L 24"D 28"H	438.00	609.00		8.9	\$
305263	Chair, Naples, Black Vinyl, 36"L 30"D 28"H	565.00	785.00		8.9	\$
305220	Chair, Roma, White Vinyl, 37"L 31"D 33"H	620.00	862.00		8.9	\$
305269	Chair, Tangiers, 34"L 37"D 36"H	509.00	708.00		8.9	\$
305070	Chair, Tub, Key West, Black, 31"L 31"D 31"H	419.00	583.00		8.9	\$
305267	Corner, Heathrow, Black Vinyl, 24"L 24"D 28"H	548.00	762.00		8.9	\$
305320	Key Largo Chair, Black Fabric, 35"L 35"D 34"H	578.00	804.00		8.9	\$
305363	Naples Chair, Powered Black Vinyl, 36"L 30"D 28"H	885.00	1,230.00		8.9	\$
305222	Roma Chair, Powered White Vinyl, 37"L 31"D 33"H	885.00	1,230.00		8.9	\$

Seating - Chairs

Item Code	Description	Discount (\$)	Regular (\$)	Qty	Tax %	Total
305152	Chair, Altura, Guest, 25"L 20"D 34"H	329.00	458.00		8.9	\$

040417 051600379

B-1 030917

Specialty Furniture Order Form

All orders are governed by the GES Payment Policy and GES Terms & Conditions of Contract as specified in this Exhibitor Services Manual.

Discount Deadline Date:
May 22, 2017

Company Name _____ Email _____ Phone Number _____

Seating - Chairs

Item Code	Description	Discount (\$)	Regular (\$)	Qty	Tax %	Total
305041	Chair, Berlin, Black/White, 18"L 22"D 32"H	133.00	185.00		8.9	\$
305042	Chair, Berlin, Red/White, 18"L 22"D 32"H	133.00	185.00		8.9	\$
305110	Chair, Brewer, Black, 20"L 20"D 32"H	165.00	229.00		8.9	\$
305260	Chair, Christopher, White Vinyl w/Chrome, 17"L 19"D 35"H	170.00	236.00		8.9	\$
305285	Chair, Duet Stack, Black/Chrome, 23"L 18.5"D 16"H	114.00	158.00		8.9	\$
305232	Chair, Fusion, Red/White, 19"L 21"D 32"H	171.00	237.00		8.9	\$
305079	Chair, Ice Transparent/Chrome, 17.25"L 20"D 32"H	240.00	334.00		8.9	\$
305271	Chair, La Brea Swivel, Charcoal Gray Fabric, 35"L 27"D 40"D	608.00	845.00		8.9	\$
305149	Chair, Luxor, Guest, 27"L 28"D 40"H	363.00	505.00		8.9	\$
305270	Chair, Madden Arm, Lt. Gray Vinyl, 27"L 32"D 33"H	627.00	872.00		8.9	\$
305284	Chair, Rustique Arm, Gunmetal, 20"L 18"D 31"H	235.00	327.00		8.9	\$
305272	Chair, Swanson Swivel, White Vinyl, 28"L 25"D 18"H	387.00	538.00		8.9	\$
305250	Chair, Wendy, Clear Acrylic, 15"L 20"D 36"H	170.00	236.00		8.9	\$
305442	Laguna Chair, 18"L 19"D 34"H	280.00	389.00		8.9	\$
305420	Malba Chair, Gray, 20"L 20"D 32"H	214.00	298.00		8.9	\$
305421	Malba Chair, Green, 20"L 20"D 32"H	214.00	298.00		8.9	\$
305441	Zenith Chair, 19"L 22"D 32"H	272.00	378.00		8.9	\$

Seating - Ottomans

Item Code	Description	Discount (\$)	Regular (\$)	Qty	Tax %	Total
305096	Endless Curved Ottoman, Black, 60.5"L 37.5"D 15"H	488.00	678.00		8.9	\$
305097	Endless Curved Ottoman, White, 60.5"L 37.5"D 15"H	488.00	678.00		8.9	\$
305277	Ottoman, Bench, Black Vinyl, 60"L 20"D 18"H	464.00	645.00		8.9	\$
305278	Ottoman, Bench, White Vinyl, 60"L 20"D 18"H	464.00	645.00		8.9	\$
305092	Ottoman, South Beach, Wedge, Platinum, 25"L 31"D 18"H	273.00	379.00		8.9	\$
305280	Ottoman, Square Seat, Black, 34"L 34"D 15"H	281.00	390.00		8.9	\$
305279	Ottoman, Square Seat, White, 34"L 34"D 15"H	281.00	390.00		8.9	\$
305251	Ottoman, Vibe Cube, Black, 18"L 18"D 18"H	126.00	175.00		8.9	\$
305246	Ottoman, Vibe Cube, Blue, Vinyl, 18"L 18"D 18"H	126.00	175.00		8.9	\$
305242	Ottoman, Vibe Cube, Champagne, Vinyl, 18"L 18"D 18"H	126.00	175.00		8.9	\$
305243	Ottoman, Vibe Cube, Gold/Bronze, Vinyl, 18"L 18"D 18"H	126.00	175.00		8.9	\$
305241	Ottoman, Vibe Cube, Green, Vinyl, 18"L 18"D 18"H	126.00	175.00		8.9	\$
305244	Ottoman, Vibe Cube, Pink, Vinyl, 18"L 18"D 18"H	126.00	175.00		8.9	\$
305245	Ottoman, Vibe Cube, Red, Vinyl, 18"L 18"D 18"H	126.00	175.00		8.9	\$
305247	Ottoman, Vibe Cube, Yellow, Vinyl, 18"L 18"D 18"H	126.00	175.00		8.9	\$

Seating - Office and Utility Seating

Item Code	Description	Discount (\$)	Regular (\$)	Qty	Tax %	Total
305126	Chair, Altura Task, 25"L 26"D 21"H	163.00	226.00		8.9	\$
305305	Chair, Executive, Pro, White, 27.5"L 27.5"D 45.7"H	396.00	550.00		8.9	\$
305147	Chair, Luxor, High Back, 27"L 28"D 47"H Adj.	448.00	623.00		8.9	\$
305148	Chair, Luxor, Med. Back, 27"L 28"D 41"H Adj.	409.00	568.00		8.9	\$
305309	Meeting Chair, White Vinyl, 25.5"L 23.5"D 34"H	334.00	464.00		8.9	\$

040417 051600379
B-1 030917

Specialty Furniture Order Form

All orders are governed by the GES Payment Policy and GES Terms & Conditions of Contract as specified in this Exhibitor Services Manual.

Discount Deadline Date:
May 22, 2017

Company Name _____ Email _____ Phone Number _____

Seating - Office and Utility Seating

305307	Pro Executive Mid Back Chair, Black Vinyl, 24"L 22"D 40"H	649.00	902.00		8.9	\$
305308	Pro Executive Mid Back Chair, White, 24"L 22"D 40"H	483.00	671.00		8.9	\$

Seating - Barstools

Item Code	Description	Discount (\$)	Regular (\$)	Qty	Tax %	Total
305370	Apex Barstool, Black Vinyl, 21"L 21"D 33"H	350.00	487.00		8.9	\$
305371	Apex Barstool, Blue Ultra Suede, 21"L 21"D 33"H	350.00	487.00		8.9	\$
305372	Apex Barstool, Red Vinyl, 21"L 21"D 33"H	350.00	487.00		8.9	\$
305373	Apex Barstool, White Vinyl, 21"L 21"D 33"H	350.00	487.00		8.9	\$
305012	Barstool, Banana, Black, 21"L 22"D 30"H	177.00	246.00		8.9	\$
305013	Barstool, Banana, White, 21"L 22"D 30"H	177.00	246.00		8.9	\$
305010	Barstool, Gin, Maple, 16"L 16"D 29"H	227.00	315.00		8.9	\$
305023	Barstool, Ice, Transparent/Chrome, 16.75"L 16"D 32"H	240.00	334.00		8.9	\$
305289	Barstool, Lift, Chrome/Black Seat, 15" Round 23-33.5"H	163.00	227.00		8.9	\$
305292	Barstool, Lift, Chrome/Gray Seat, 15" Round 23-33.5"H	163.00	227.00		8.9	\$
305291	Barstool, Lift, Chrome/Red Seat, 15" Round 23-33.5"H	163.00	227.00		8.9	\$
305290	Barstool, Lift, Chrome/White Seat, 15" Round 23-33.5"H	163.00	227.00		8.9	\$
305009	Barstool, Oslo, Blue, 17"L 20"D 30"H	323.00	449.00		8.9	\$
305008	Barstool, Oslo, White, 17"L 20"D 30"H	323.00	449.00		8.9	\$
305288	Barstool, Rustique, Gunmetal, 13"L 13"D 30"D	209.00	291.00		8.9	\$
305206	Barstool, Shark Swivel, White/Chrome Base, 22"L 19"D 34"- 44"H	450.00	625.00		8.9	\$
305207	Barstool, Zooey Swivel, White/Chrome Base, 15"Lx17"Dx31"-35"H	412.00	573.00		8.9	\$
305259	Christopher Barstool, 19"L 15"D 41"H	350.00	487.00		8.9	\$
305440	Zenith Barstool, 19"L 20"D 44"H	366.00	509.00		8.9	\$

Tables - Cafe

Item Code	Description	Discount (\$)	Regular (\$)	Qty	Tax %	Total
305426	Cafe Table/Hydraulic Chrome Base, Liquid Steel Blue, 30"RND 29"H	424.00	590.00		8.9	\$
305428	Café Table/Black Base, Liquid Steel Blue, 30"RND 29"H	318.00	442.00		8.9	\$
305067	G30 Cafe Table, Powered White Top, 72"L 26"D 30"H	1,310.00	1,820.00		8.9	\$
305429	Madison Cafe Table/Hydraulic Base, 30"RND 29"H	495.00	688.00		8.9	\$
305153	Table, Cafe, Brushed Red/Hydraulic Chrome Base, 30" Round 29"H	329.00	458.00		8.9	\$
305164	Table, Cafe, Graphite/Black, 30" Round 29"H	247.00	344.00		8.9	\$
305167	Table, Cafe, Graphite/Black, 36" Round 29"H	288.00	401.00		8.9	\$
305156	Table, Cafe, Graphite/Hydraulic Chrome Base, 30" Round 29"H	329.00	458.00		8.9	\$
305159	Table, Cafe, Graphite/Hydraulic Chrome Base, 36" Round 29"H	391.00	544.00		8.9	\$
305165	Table, Cafe, Maple/Black, 30" Round 29"H	247.00	344.00		8.9	\$
305168	Table, Cafe, Maple/Black, 36" Round 29"H	288.00	401.00		8.9	\$
305157	Table, Cafe, Maple/Hydraulic Chromr Base, 30" Round 29"H	329.00	458.00		8.9	\$
305160	Table, Cafe, Maple/Hydraulic Chrome Base, 36" Round 29"H	391.00	544.00		8.9	\$
305161	Table, Cafe, Red/Black, 30" Round 29"H	247.00	344.00		8.9	\$
305282	Table, Cafe, Silver Texture/Black Base, 30" Round 29"H	253.00	351.00		8.9	\$
305299	Table, Cafe, Silver Textured Grain/Hydraulic Chrome Base, 30" R	317.00	441.00		8.9	\$

B-1 030917 040417 051600379

Specialty Furniture Order Form

All orders are governed by the GES Payment Policy and GES Terms & Conditions of Contract as specified in this Exhibitor Services Manual.

Discount Deadline Date:
May 22, 2017

Company Name _____ Email _____ Phone Number _____

Tables - Cafe						
305283	Table, Cafe, White Laminate/Black Base, 36" Round 29"H	288.00	401.00		8.9	\$
305301	Table, Cafe, White Laminate/Hydraulic Chrome Base, 36" Round	391.00	544.00		8.9	\$

Tables - Bar						
Item Code	Description	Discount (\$)	Regular (\$)	Qty	Tax %	Total
305425	Bar Table/Hydraulic Chrome Base, Steel Blue, 30"RND 45"H	424.00	589.00		8.9	\$
305071	G30 Bar Table, Powered White Top, 72"L 26"D 42"H	1,720.00	2,390.00		8.9	\$
305405	Madison Bar Table/Black Base, 30"RND 42"H	499.00	693.00		8.9	\$
305139	Table, Bar, Brushed Red/Hydraulic Chrome Base, 30" Round 45"	336.00	467.00		8.9	\$
305133	Table, Bar, Graphite/Black, 30" Round 42"H	258.00	359.00		8.9	\$
305136	Table, Bar, Graphite/Black, 36" Round 42"H	319.00	443.00		8.9	\$
305142	Table, Bar, Graphite/Hydraulic Chrome Base, 30" Round 45"H	336.00	467.00		8.9	\$
305145	Table, Bar, Graphite/Hydraulic Chrome Base, 36" Round 45"H	396.00	550.00		8.9	\$
305134	Table, Bar, Maple/Black, 30" Round 42"H	258.00	359.00		8.9	\$
305137	Table, Bar, Maple/Black, 36" Round 42"H	319.00	443.00		8.9	\$
305143	Table, Bar, Maple/Hydraulic Chrome Base, 30" Round 45"H	336.00	467.00		8.9	\$
305146	Table, Bar, Maple/Hydraulic Chrome Base, 36" Round 45"H	396.00	550.00		8.9	\$
305130	Table, Bar, Red/Black, 30" Round 42"H	258.00	359.00		8.9	\$
305286	Table, Bar, Silver Textured Grain/Black Base, 30" Round 42"H	276.00	383.00		8.9	\$
305302	Table, Bar, Silver Textured Grain/Hydraulic Chrome Base, 30" Ro	338.00	470.00		8.9	\$
305287	Table, Bar, White Laminate/Black Base, 36" Round 42"H	319.00	443.00		8.9	\$
305303	Table, Bar, White Laminate/Hydraulic Chrome Base, 36" Round 4	327.00	455.00		8.9	\$

Tables - Cocktail						
Item Code	Description	Discount (\$)	Regular (\$)	Qty	Tax %	Total
305430	Alondra Cocktail Table, Glass, 47"L 24"D 16"H	459.00	638.00		8.9	\$
305189	G30 Cocktail Table, Powered White Top, 72"L 26"D 18"H	942.00	1,310.00		8.9	\$
305435	Geo Cocktail Table, Wood, 47"L 24"D 17"H	350.00	486.00		8.9	\$
305188	Sydney Powered Cocktail Table, Black, 48"L 26"D 18"H	540.00	750.00		8.9	\$
305187	Sydney Powered Cocktail Table, White, 48"L 26"D 18"H	540.00	750.00		8.9	\$
305014	Table, Cocktail, Geo, Chrome, 50"L 22"D 16"H	270.00	375.00		8.9	\$
305210	Table, Cocktail, Oliver, 47"L 27"D 19"H	255.00	354.00		8.9	\$
305016	Table, Cocktail, Silverado, 36" Round 17"H	310.00	431.00		8.9	\$
305025	Table, Cocktail, Sydney Black, 48"L 26"D 18"H	368.00	511.00		8.9	\$
305024	Table, Cocktail, Sydney White, 48"L 26"D 18"H	368.00	511.00		8.9	\$

Tables - End Tables						
Item Code	Description	Discount (\$)	Regular (\$)	Qty	Tax %	Total
305431	Alondra End Table, Glass, 20"L 20"D 20"H	421.00	585.00		8.9	\$
305436	Geo End Table, Wood, 20"L 20"D 21"H	303.00	421.00		8.9	\$
305112	Regis End Table, 16"L 15.5"D 16.5"H	429.00	596.00		8.9	\$
305273	Table, Aura, White Metal, 15" Round 22"H	186.00	258.00		8.9	\$
305274	Table, E, Wood, 21"L 15.5"D 27.5"H	177.00	246.00		8.9	\$
305044	Table, End, Geo, Chrome, 26"L 26"D 20"H	245.00	340.00		8.9	\$

B-1 030917 040417 051600379



Specialty Furniture Order Form

All orders are governed by the GES Payment Policy and GES Terms & Conditions of Contract as specified in this Exhibitor Services Manual.

Discount Deadline Date:
May 22, 2017

Company Name _____ Email _____ Phone Number _____

305211	Table, End, Oliver, 22" Round 22"H	222.00	308.00		8.9	\$
305046	Table, End, Silverado, 24" Round 22"H	291.00	404.00		8.9	\$
305050	Table, End, Sydney, Black, 27"L 23"D 22"H	270.00	375.00		8.9	\$
305048	Table, End, Sydney, White, 27"L 23"D 22"H	270.00	375.00		8.9	\$
305276	Table, Mosaic, Set of 3	345.00	479.00		8.9	\$
305275	Table, Timber, Wood, 16" Round 17"H	217.00	301.00		8.9	\$

Tables - Conference

Item Code	Description	Discount (\$)	Regular (\$)	Qty	Tax %	Total
305402	10' Madison Table, 120"L 48"D 29"H	942.00	1,310.00		8.9	\$
305400	5' Madison Table, 60"L 48"D 29"H	636.00	884.00		8.9	\$
305401	8' Madison Table, 96"L 60"D 29"H	777.00	1,080.00		8.9	\$
305410	Madison Conference Table, 42"RND 29"H	578.00	804.00		8.9	\$
305190	Powered Conference Table Module, Black, 5"L 2.25"D 2"H	114.00	158.00		8.9	\$
305175	Table, Conf., Geo, Black, 42"L 42"D 29"H	299.00	416.00		8.9	\$
305176	Table, Conf., Geo, Black, 60"L 36"D 29"H	481.00	669.00		8.9	\$
305173	Table, Conf., Geo, Chrome, 42"L 42"D 29"H	317.00	441.00		8.9	\$
305174	Table, Conf., Geo, Chrome, 60"L 36"D 29"H	481.00	669.00		8.9	\$
305027	Table, Conf., Graphite, 42" Round 29"H	396.00	550.00		8.9	\$
305028	Table, Conf., Graphite, 72"L 42"D 29"H	535.00	743.00		8.9	\$
305029	Table, Conf., Graphite, 96"L 48"D 29"H	655.00	911.00		8.9	\$
305177	Table, Conf., Manhattan, 42" Round 29"H	361.00	502.00		8.9	\$
305293	Table, Conf., Merlin, Gray Laminate/Black, 46"L 29"D 30"H	518.00	720.00		8.9	\$
305281	Table, Conf., White Laminate, 42" Round 29"H	419.00	583.00		8.9	\$

Tables - Martini Bar

Item Code	Description	Discount (\$)	Regular (\$)	Qty	Tax %	Total
305004	Table, Bar, Martini 3 pc., 100"L 100"D 47"H	3,450.00	4,800.00		8.9	\$
305003	Table, Bar, Martini, 50"L 50"D 47"H	1,300.00	1,810.00		8.9	\$

Product Display

Item Code	Description	Discount (\$)	Regular (\$)	Qty	Tax %	Total
305053	Etagere, Black, 30"L 16"D 70"H	347.00	482.00		8.9	\$
305052	Etagere, Pewter, 30"L 16"D 70"H	347.00	482.00		8.9	\$
305415	Madison Bookcase, 36"L 12"D 72"H	483.00	671.00		8.9	\$
305297	Pedestal, Powered Locking, Black, 24"L 24"D 30"H	695.00	966.00		8.9	\$
305295	Pedestal, Powered Locking, Black, 24"L 24"D 42"H	835.00	1,160.00		8.9	\$
305298	Pedestal, Powered Locking, White, 24"L 24"D 30"H	695.00	966.00		8.9	\$
305296	Pedestal, Powered Locking, White, 24"L 24"D 42"H	835.00	1,160.00		8.9	\$

Office and Utility Furniture

Item Code	Description	Discount (\$)	Regular (\$)	Qty	Tax %	Total
305294	Desk, Writing/Work Table, White Laminate/White, 48"L 24"D 30"H	494.00	687.00		8.9	\$
305416	Madison Credenza, 60"L 20"D 29"H	799.00	1,110.00		8.9	\$
305417	Madison Executive Desk, 60"L 30"D 29"H	727.00	1,010.00		8.9	\$

040417 051600379

B-1 030917

Specialty Furniture Order Form

All orders are governed by the GES Payment Policy and GES Terms & Conditions of Contract as specified in this Exhibitor Services Manual.

Discount Deadline Date:
May 22, 2017

Company Name _____ Email _____ Phone Number _____

Lamps

Item Code	Description	Discount (\$)	Regular (\$)	Qty	Tax %	Total
305204	Lamp, Floor, Mason, Silver, 18" Round 55"H	307.00	427.00		8.9	\$
305205	Lamp, Table, Mason, Silver, 16" Round 26"H	224.00	311.00		8.9	\$

Accessories

Item Code	Description	Discount (\$)	Regular (\$)	Qty	Tax %	Total
305380	Charging Adapter, Black, 33"L	31.50	43.75		8.9	\$
305381	Charging Adapter, White, 33"L	31.50	43.75		8.9	\$

Electrical Outlets Not Included



Need power for that lamp or powered pedestal in your booth? Order electrical outlets separately for your booth space through the electrical service provider.

Reminder

Total and Sign: Return to Fax: 866.329.1437 • International Fax: 702.263.1520

Please Sign

X

Authorized Signature

Authorized Name - Please Print

Date

I agree in placing this order that I have accepted GES Payment Policy and GES Terms & Conditions of Contract, including authorization for GES to retain personal information to better serve my need for GES services at future events.

Total Payment Enclosed

\$

Cancellation Policy: Items cancelled will be charged **100%** of original price after move-in begins.

040417 051600379

B-1 030917

Convenience Package Order Form

All orders are governed by the GES Payment Policy and GES Terms & Conditions of Contract as specified in this Exhibitor Services Manual.

Forest Products Machinery & Equipment Exposition
 Georgia World Congress Center
 June 14 - 16, 2017

Discount Deadline Date:
 May 22, 2017

Company Name _____ Email _____ Phone Number _____ Booth Number _____



Easy Ordering Tips:

- All prices include delivery, rental, and removal.
- Return your orders three (3) weeks before show move-in to ensure availability. At show site some items may not be available and substitutions might be necessary.
- Enjoy a fast and easy ordering experience online with Expresso:
<http://e.ges.com/051600379/packages/esm>



Stool Package A



Chair Package A

Standard Furniture Package

Item Code	Description	Discount (\$)	Regular (\$)	Qty	Tax %	Total
404301	Chair Package A	571.55	793.75		8.9	\$
	↳ Includes: (2) Contemporary Arm Chairs, (1) Starbase Table 40"X30", (1) Wastebasket.					
404323	Display Case Package A	1,293.00	1,797.00		8.9	\$
	↳ Includes: (2) Contemporary Stools, (1) Starbase Table 30"X40", (1) 6' Half View Display Case.					
404324	Display Case Package B	1,243.00	1,727.00		8.9	\$
	↳ Includes: (2) Contemporary Arm Chairs, (1) Starbase Table 40"X30", (1) 6' Half View Display Case.					
404322	Meeting Package	849.55	1,274.25		8.9	\$
	↳ Includes: (4) Contemporary Arm Chairs, (1) Starbase Table 40"X30", (1) Wastebasket.					
404311	Stool Package A	621.55	863.75		8.9	\$
	↳ Includes: (2) Contemporary Stools, (1) Starbase Table 30"X40", (1) Wastebasket.					

Standard Skirted Furniture Package

Item Code	Description	Color Code	Discount (\$)	Regular (\$)	Qty	Tax %	Total
4046	Chair Package B		475.55	660.75		8.9	\$
	↳ Includes: (2) Contemporary Arm Chairs, (1) 6' Skirted Table 24"X30", (1) Wastebasket.						
4146	Stool Package B		571.55	794.75		8.9	\$
	↳ Includes: (2) Contemporary Stools, (1) 6' Skirted Counter 24"X42", (1) Wastebasket.						

Skirt Color Options

(Gray will be provided if no color is indicated.)



040417 051600379

P-1 030917

Form Continues on Next Page

Convenience Package Order Form

All orders are governed by the GES Payment Policy and GES Terms & Conditions of Contract as specified in this Exhibitor Services Manual.

Company Name _____ Email _____ Phone Number _____

Specialty Furniture Package

Item Code	Description	Discount (\$)	Regular (\$)	Qty	Tax %	Total
404504	Bar Package	1,946.00	2,708.00		8.9	\$
	↳ Includes: (2) White Oslo Barstools, (1) Martini Bar.					
404506	Premium Stool Package	690.00	959.00		8.9	\$
	↳ Includes: (2) White Banana Barstools, (1) Bar Table 30"X42".					

Total and Sign: Return to Fax: 866.329.1437 • International Fax: 702.263.1520

Please Sign _____
 Authorized Signature

_____ Date
 Authorized Name - Please Print

I agree in placing this order that I have accepted GES Payment Policy and GES Terms & Conditions of Contract, including authorization for GES to retain personal information to better serve my need for GES services at future events.

Total Payment Enclosed \$

Cancellation Policy: Package items cancelled will be charged **50%** of original price after move-in begins and **100%** of original price after installation.

040417 051600379

P-1 030917

Standard Exhibit Systems

With the following GES® standard exhibits to choose from, selecting the size and configuration that meets your tradeshow needs is easy. Our modular exhibits are hassle-free because you pay no design fees, no shipping fees, and no repair or refurbishing fees. Plus, you may customize the trim and panels, and choose from a wide variety of accessories to create a unique exhibit that reinforces your brand and marketing efforts.

All packages include rental, delivery, installation, and dismantling. For other custom furnishings, hanging signs, or graphics, chat with your GES National Servicenter® representative at www.ges.com/chat.

20x20 Exhibits

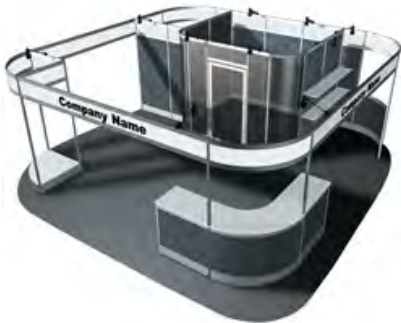

600005 - Exhibit System GEM #5, 20'x20' Island Includes:

- three digitally printed signs
- one locking office
- four shelves
- one curved counter
- two 1m counters
- ten arm lights
- one standard 20' x 20' carpet
- no padding

10x20 Exhibits

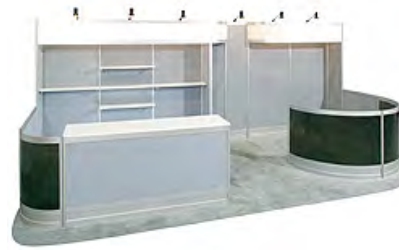

600004 - Exhibit System GEM #4, 10'x20' Inline Includes:

- one 117" x 12" digitally printed sign
- one 57-7/8" x 12" digitally printed sign
- one 2m counter
- six arm lights
- five shelves
- one standard 10' x 20' carpet
- no padding

10x10 Exhibits



600002 - Exhibit System GEM #2, 10'x10' Inline Includes:

- one custom ID sign
- two arm lights
- one standard 10' x 10' carpet
- no padding



600003 - Exhibit System GEM #3, 10'x10' Inline Includes:

- one custom ID sign
- three arm lights
- five shelves
- one 1m counter
- one standard 10' x 10' carpet
- no padding

6ft Table Display



600001 - Exhibit System GEM #1, 6' Tabletop Display Includes:

- one custom ID sign
- three arm lights
- two shelves
- one 6' skirted table
- no carpet and padding

Please note that although arm lights may be included in your package, electrical power must be ordered separately through the electrical services provider in your exhibitor service manual. Colors may vary due to facility lighting, printing limitations and dye lot differences.

Standard Exhibit Systems

Accessories



600410 - Exhibit, Ad Board, 1M x 8'



600110 - Exhibit, Armlight Black



600103 - Exhibit, Counter, 1M Curved



600101 - Exhibit, Counter, 1M x 1/2M x 40"H



600102 - Exhibit, Counter, 2M x 1/2M x 40"H



600221 - Exhibit, Light Box, Large 37"x85"



600222 - Exhibit, Light Box, Medium 37"x56"



600223 - Exhibit, Light Box, Small 37"x28"



661931 - Exhibit, Panel, Slatwall, 1M x 8'

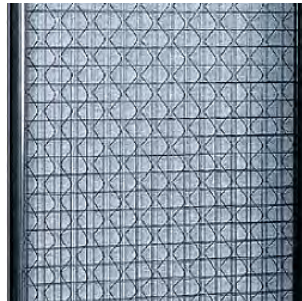

600291 - Exhibit, Panel, Wirewall, 1M



600243 - Exhibit, Shelf, 1M x 10" Deep

Trim and Panel Choices

Panel Type & Color

● Coated: Black (C41)

○ Coated: Oxford White (C50)

● Coated: Prism Blue (C42)

● Coated: Silver Gray (C79)

● Fabric: Black (F41)

● Fabric: Blue (F42)

● Fabric: Gray (F40)

Trim Color

● Black (41)

● Silver (79)

Please note that although arm lights may be included in your package, electrical power must be ordered separately through the electrical services provider in your exhibitor service manual. Colors may vary due to facility lighting, printing limitations and dye lot differences.

Standard Exhibits Graphics

Exhibit #1, 6' Tabletop (600001)

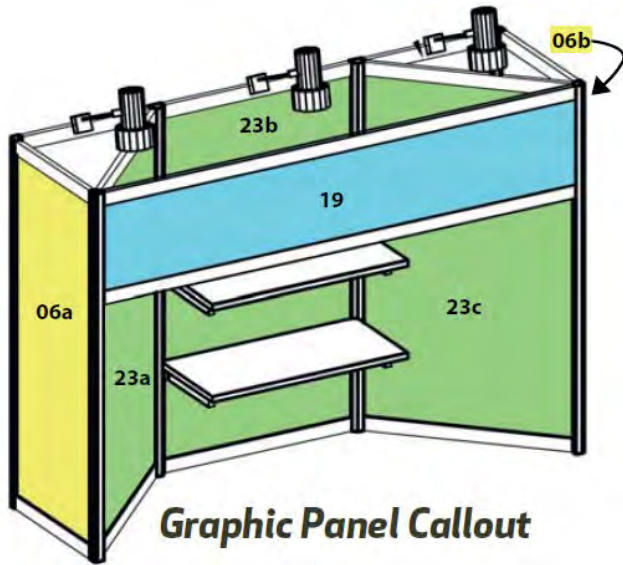

Graphic Panel Callout

- 23** 608323 26 9/16" wide x 45" tall
Discount Price - \$183.00 /Regular Price - \$255.00
Produced on 3/16" Thick White Foamcore
- 06** 608306 18 7/16" wide x 45" tall
Discount Price - \$75.50 /Regular Price - \$105.00
Produced on 3/16" Thick White Foamcore
- 19** 608319 65 15/16" wide x 12" tall
Discount Price - \$121.00 /Regular Price - \$168.00
Produced on 3/16" Thick White Foamcore

All Prices listed above are Per Panel.

Please note that pricing listed is for Graphic Panels only. GEM units are rented separately.

GES requires a form of payment for booth graphics in order to produce signage. Please see Payment and Credit Card Authorization (G-2) for required information.

Please contact GES National Service Center at 800-475-2098 or 702-515-5970 with any questions or concerns.

Link: <https://e.ges.com/051600379/exhibit1/esm>



Booth Rendering

Please note that although arm lights may be included in your package, electrical power must be ordered separately through the electrical services provider in your exhibitor service manual. Colors may vary due to facility lighting, printing limitations and dye lot differences.

Standard Exhibits Graphics

Exhibit #2, 10 x 10 (600002)

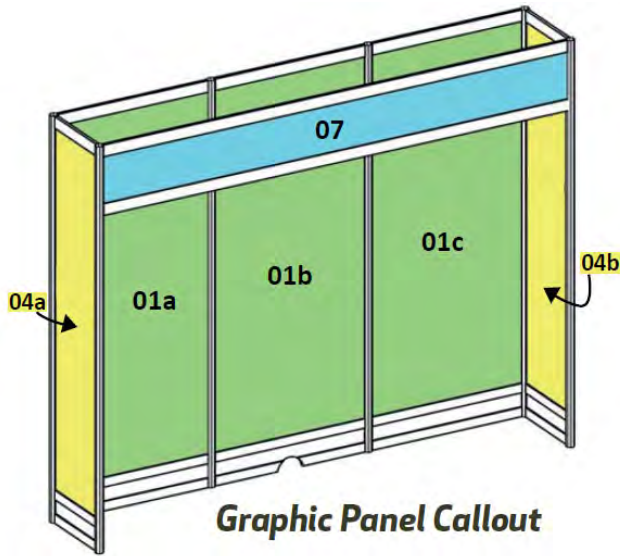

- 01** 608301 38 1/8" wide x 86 1/4" tall
 Discount Price - \$504.00 /Regular Price - \$700.00
 Produced on 3/16" Thick White Foamcore
- 04** 608304 18 7/16" wide x 86 1/4" tall
 Discount Price - \$253.00 /Regular Price - \$352.00
 Produced on 3/16" Thick White Foamcore
- 07** 608307 117" wide x 12" tall
 Discount Price - \$214.00 /Regular Price - \$298.00
 Produced on 3/16" Thick White Foamcore

All Prices listed above are Per Panel.

Please note that pricing listed is for Graphic Panels only. GEM units are rented separately.

GES requires a form of payment for booth graphics in order to produce signage. Please see Payment and Credit Card Authorization (G-2) for required information.

Please contact GES National Service Center at 800-475-2098 or 702-515-5970 with any questions or concerns.

Link: <https://e.ges.com/051600379/exhibit2/esm>



Booth Rendering

Please note that although arm lights may be included in your package, electrical power must be ordered separately through the electrical services provider in your exhibitor service manual. Colors may vary due to facility lighting, printing limitations and dye lot differences.

Standard Exhibits Graphics

Exhibit #3, 10 x 10 (600003)

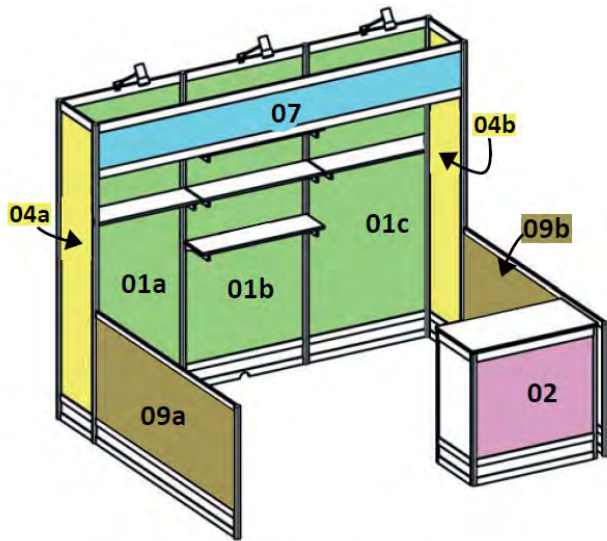

Graphic Panel Callout

- 01** 608301 38 1/8" wide x 86 1/4" tall
 Discount Price - \$504.00 /Regular Price - \$700.00
 Produced on 3/16" Thick White Foamcore
- 04** 608304 18 7/16" wide x 86 1/4" tall
 Discount Price - \$253.00 /Regular Price - \$352.00
 Produced on 3/16" Thick White Foamcore
- 07** 608307 117" wide x 12" tall
 Discount Price - \$214.00 /Regular Price - \$298.00
 Produced on 3/16" Thick White Foamcore
- 02** 608302 38 1/8" wide x 30 1/4" tall
 Discount Price - \$178.00 /Regular Price - \$247.00
 Produced on 3/16" Thick White Foamcore
- 09** 608309 77 1/2" wide x 30 1/4" tall
 Discount Price - \$360.00 /Regular Price - \$500.00
 Produced on 3/16" Thick White Foamcore

All Prices listed above are Per Panel.

Please note that pricing listed is for Graphic Panels only. GEM units are rented separately.

GES requires a form of payment for booth graphics in order to produce signage. Please see Payment and Credit Card Authorization (G-2) for required information.

Please contact GES National Service Center at 800-475-2098 or 702-515-5970 with any questions or concerns.

Link: <https://e.ges.com/051600379/exhibit3/esm>



Booth Rendering

Please note that although arm lights may be included in your package, electrical power must be ordered separately through the electrical services provider in your exhibitor service manual. Colors may vary due to facility lighting, printing limitations and dye lot differences.

Standard Exhibits Graphics

Exhibit #4, 10 x 20 (600004)

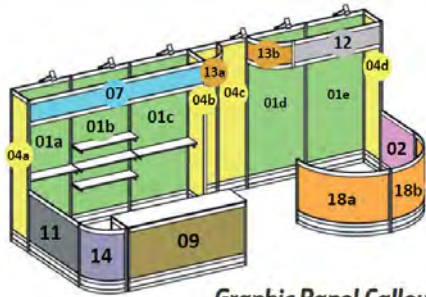

Graphic Panel Callout

- 12** 608312 57 7/8" wide x 12" tall
Discount Price - \$111.00 /Regular Price - \$154.00
Produced on 3/16" Thick White Foamcore
- 13** 608313 29 3/4" wide x 12" tall
Discount Price - \$55.00 /Regular Price - \$76.50
Produced on 1/8" Thick White Foamacell
- 18** 608318 60 3/4" wide x 30 1/4" tall
Discount Price - \$283.00 /Regular Price - \$393.00
Produced on 1/8" Thick White Foamacell
- 09** 608309 77 1/2" wide x 30 1/4" tall
Discount Price - \$360.00 /Regular Price - \$500.00
Produced on 3/16" Thick White Foamcore
- 14** 608314 29 3/4" wide x 30 1/4" tall
Discount Price - \$137.00 /Regular Price - \$191.00
Produced on 1/8" Thick White Foamacell

- 01** 608301 38 1/8" wide x 86 1/4" tall
Discount Price - \$504.00 /Regular Price - \$700.00
Produced on 3/16" Thick White Foamcore
- 04** 608304 18 7/16" wide x 86 1/4" tall
Discount Price - \$253.00 /Regular Price - \$352.00
Produced on 3/16" Thick White Foamcore
- 11** 608311 57 7/8" wide x 30 1/4" tall
Discount Price - \$106.00 /Regular Price - \$148.00
Produced on 3/16" Thick White Foamcore
- 02** 608302 38 1/8" wide x 30 1/4" tall
Discount Price - \$178.00 /Regular Price - \$247.00
Produced on 3/16" Thick White Foamcore
- 07** 608307 117" wide x 12" tall
Discount Price - \$214.00 /Regular Price - \$298.00
Produced on 3/16" Thick White Foamcore



Booth Rendering

All Prices listed above are Per Panel.

Please note that pricing listed is for Graphic Panels only. GEM units are rented separately.

GES requires a form of payment for booth graphics in order to produce signage. Please see Payment and Credit Card Authorization (G-2) for required information.

Please contact GES National Service Center at 800-475-2098 or 702-515-5970 with any questions or concerns.

Link: <https://e.ges.com/051600379/exhibit4/esm>

Please note that although arm lights may be included in your package, electrical power must be ordered separately through the electrical services provider in your exhibitor service manual. Colors may vary due to facility lighting, printing limitations and dye lot differences.

Standard Exhibits Graphics

Exhibit #5, 20 x 20 (600005)

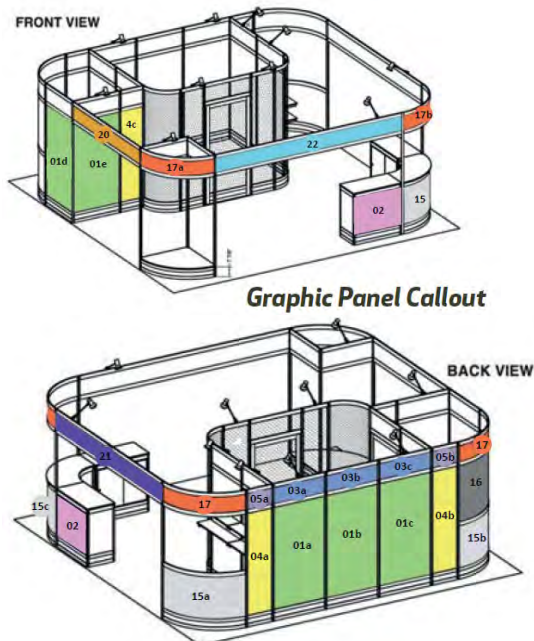

- 21** 608321 136 9/16" wide x 12" tall
 Discount Price - \$166.00 /Regular Price - \$231.00
 Produced on 3/16" Thick White Foamcore
- 20** 608320 97 3/16" wide x 12" tall
 Discount Price - \$178.00 /Regular Price - \$248.00
 Produced on 1/8" Thick White Foamcore
- 17** 608317 60 11/16" wide x 12" tall
 Discount Price - \$207.00 /Regular Price - \$288.00
 Produced on 1/8" Thick White Foamacell
- 02** 608302 38 1/8" wide x 30 1/4" tall
 Discount Price - \$178.00 /Regular Price - \$247.00
 Produced on 3/16" Thick White Foamcore
- 03** 608303 38 1/8" wide x 12" tall
 Discount Price - \$70.75 /Regular Price - \$98.25
 Produced on 3/16" Thick White Foamcore
- 05** 608305 18 7/16" wide x 12" tall
 Discount Price - \$55.00 /Regular Price - \$76.50
 Produced on 3/16" Thick White Foamcore

- 01** 608301 18 7/16" wide x 86 1/4" tall
 Discount Price - \$504.00 /Regular Price - \$700.00
 Produced on 3/16" Thick White Foamcore
- 04** 608304 18 7/16" wide x 86 1/4" tall
 Discount Price - \$253.00 /Regular Price - \$352.00
 Produced on 3/16" Thick White Foamcore
- 16** 608316 60 11/16" wide x 40 1/4" tall
 Discount Price - \$337.00 /Regular Price - \$469.00
 Produced on 1/8" Thick White Foamacell
- 15** 608315 60 11/16" wide x 30 1/4" tall
 Discount Price - \$283.00 /Regular Price - \$393.00
 Produced on 1/8" Thick White Foamacell
- 22** 608322 156 1/4" wide x 12" tall
 Discount Price - \$286.00 /Regular Price - \$398.00
 Produced on 3/16" Thick White Foamcore



Booth Rendering

All Prices listed above are Per Panel.

Please note that pricing listed is for Graphic Panels only. GEM units are rented separately.

GES requires a form of payment for booth graphics in order to produce signage. Please see Payment and Credit Card Authorization (G-2) for required information.

Please contact GES National Service Center at 800-475-2098 or 702-515-5970 with any questions or concerns.

Link: <https://e.ges.com/051600379/exhibit5/esm>

Please note that although arm lights may be included in your package, electrical power must be ordered separately through the electrical services provider in your exhibitor service manual. Colors may vary due to facility lighting, printing limitations and dye lot differences.

Exhibit Systems Order Form

All orders are governed by the GES Payment Policy and GES Terms & Conditions of Contract as specified in this Exhibitor Services Manual.

Forest Products Machinery & Equipment Exposition
 Georgia World Congress Center
 June 14 - 16, 2017

Discount Deadline Date:
 May 22, 2017

Company Name _____ Email _____ Phone Number _____ Booth Number _____



Easy Ordering Tips:

- All prices include delivery, rental, and removal.
- Return your orders three (3) weeks before show move-in to ensure availability. At show site some items may not be available and substitutions might be necessary.
- Arm lights and shelves cannot be placed on pipe and drape.

13 oz. Carpet Color Options
 (Gray will be provided if no color is indicated below)

(41) (42) (56) (40) (45) (52) (49)

Exhibit Panel Color Options
 (Gray Fabric Panel will be provided if no color is indicated below)

(C41) (C50) (C42) (C79) (F41) (F42) (F40)

C Color Codes are Coated Panels
 F Color Codes are Fabric

Trim Color Options
 (Silver will be provided if no color is indicated below)

(41) (79)

Standard Exhibits

10x10 Exhibits

Item Code	Description	Discount (\$)	Regular (\$)	Qty	Tax %	Total
600002	Exhibit System GEM #2, 10'x10' Inline	2,050.00	2,850.00		8.9	\$
	↳ Carpet Color Code: _____ Trim Color: _____ Panel Color: _____					
600003	Exhibit System GEM #3, 10'x10' Inline	3,860.00	5,370.00		8.9	\$
	↳ Carpet Color Code: _____ Trim Color: _____ Panel Color: _____					

10x20 Exhibits

Item Code	Description	Discount (\$)	Regular (\$)	Qty	Tax %	Total
600004	Exhibit System GEM #4, 10'x20' Inline	8,470.00	11,770.00		8.9	\$
	↳ Carpet Color Code: _____ Trim Color: _____ Panel Color: _____					

20x20 Exhibits

Item Code	Description	Discount (\$)	Regular (\$)	Qty	Tax %	Total
600005	Exhibit System GEM #5, 20'x20' Island	12,600.00	17,520.00		8.9	\$
	↳ Carpet Color Code: _____ Trim Color: _____ Panel Color: _____					

Accessories

Item Code	Description	Discount (\$)	Regular (\$)	Qty	Tax %	Total
600410	Exhibit, Ad Board, 1M x 8'	665.00	925.00		8.9	\$
600110	Exhibit, Armlight Black	99.25	138.00		8.9	\$
600103	Exhibit, Counter, 1M Curved	914.00	1,270.00		8.9	\$
	↳ Trim Color: _____ Panel Color: _____					
600101	Exhibit, Counter, 1M x 1/2M x 40"H	465.00	647.00		8.9	\$
	↳ Trim Color: _____ Panel Color: _____					
600102	Exhibit, Counter, 2M x 1/2M x 40"H	638.00	887.00		8.9	\$
	↳ Trim Color: _____ Panel Color: _____					
600221	Exhibit, Light Box, Large 37"x85"	849.00	1,180.00		8.9	\$
600222	Exhibit, Light Box, Medium 37"x56"	668.00	928.00		8.9	\$
600223	Exhibit, Light Box, Small 37"x28"	412.00	573.00		8.9	\$
661931	Exhibit, Panel, Slatwall, 1M x 8'	582.00	809.00		8.9	\$
600291	Exhibit, Panel, Wirewall, 1M	570.00	792.00		8.9	\$

040417 051600379 D-1 013117



Exhibit Systems Order Form

All orders are governed by the GES Payment Policy and GES Terms & Conditions of Contract as specified in this Exhibitor Services Manual.

Discount Deadline Date:
May 22, 2017

Company Name _____ Email _____ Phone Number _____ Booth Number _____

Accessories

600243	Exhibit, Shelf, 1M x 10" Deep	77.75	108.00	8.9	\$
--------	-------------------------------	-------	--------	-----	----

Electrical or Utilities Under Carpet?

Yes No

Total and Sign: Return to Fax: 866.329.1437 • International Fax: 702.263.1520

Please Sign

X

Authorized Signature

Authorized Name - Please Print

Date

I agree in placing this order that I have accepted GES Payment Policy and GES Terms & Conditions of Contract, including authorization for GES to retain personal information to better serve my need for GES services at future events.

Total Payment Enclosed

\$

Cancellation Policy: Items cancelled will be charged **50%** of original price after move-in begins and **100%** of original price after installation.

040417 051600379

D-1 013117

Digital File Preparation

All orders are governed by the GES Payment Policy and GES Terms & Conditions of Contract as specified in this Exhibitor Services Manual.

Forest Products Machinery & Equipment Exposition
 Georgia World Congress Center
 June 14 - 16, 2017

Graphic File Solutions

We are committed to partnering with you to provide comprehensive and effective graphic solutions for your event. The graphics print and production industry continuously evolves, and we want your graphics and images to look their absolute best.

To ensure the highest quality output from your digital files, and to make file transfers as seamless as possible, please review and follow these guidelines when submitting artwork to GES. We also offer layout and design services for a fee. Please contact GES for details.

Suitable Programs for images or logos	
Program	Preferred Format
Adobe Illustrator CS6, CC 2014	.ai, .eps
Adobe Photoshop CS6, CC 2014	.tif (LZW), .jpg (High Quality), .psd
Adobe InDesign CS6, CC 2014	.indd (include all links)
Adobe Acrobat	.pdf (Press Quality Setting)

Suitable Media for images or logos	
Media	Preferred Format
CD-ROM	Hard copy color proofs
DVD-ROM	Hard copy color proofs
Email Attachments	Limited to maximum size of 5MB
FTP	Mandatory ZIP or SIT compression



- Save money by providing your artwork/graphic files in the recommended formats.
- Send your graphics early with client name, show name, and booth number to avoid costly delays.
- Do not copy graphics from web pages as they will be low resolution and not suitable for your exhibit/sign.

Avoiding Additional Costs

Files obtained from the internet (.jpg or .gif) or artwork created in MS Office applications (Word, Excel, PowerPoint) are often not suitable for high quality output, and often require additional hourly charges. Artwork should be created at actual size, however, for larger files i.e., banner artwork, 10% or 25% of actual size is acceptable. Scans should be no smaller than 300dpi at quarter size. To avoid additional costs associated with these file types, please supply files in accordance as defined herein.

Vector Artwork

For the best quality, create in vector format (ai or vector eps).

Logos taken from websites are generally GIF files. GIF files are not acceptable as they will not print clearly. See Visual.

Artwork produced in vinyl, for example, solid company logos or text must be supplied in a vector format (ai or vector eps). Artwork created in a pixel format i.e., TIFF and JPEG is not suitable. See Visual.

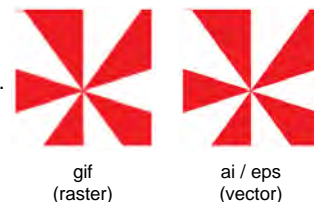

Bitmap/Raster Artwork

TIFF and PSD - These are the preferred file formats for raster images. Files should be supplied at 100dpi at full size, or they should re-scale to those dimensions. If the resolution is lower than 100dpi, images can look blurry or pixelated when printed. If there is a lot of small text in the raster image, the file can be provided at higher resolutions to ensure print quality. See Visual.

JPEG - We can use JPEG files, but because JPEGs use file compression this can sometimes affect image quality. Therefore, this file type should only be used if the files are being emailed.

PDF - These are print files only and cannot be altered to fit different sizes, artwork must be set up at the correct proportion and at print-ready quality. Ensure images are saved at high resolution (100dpi at final size).

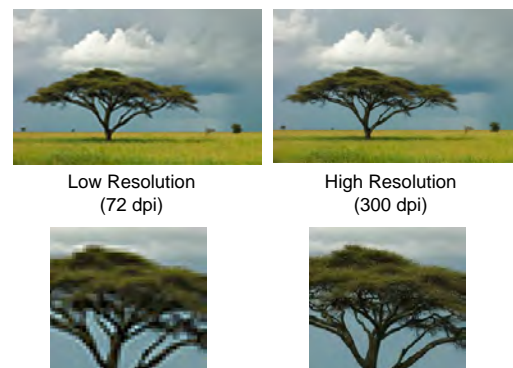

Order graphics and **upload artwork files** directly online, click here: <https://e.ges.com/051600379/signs>

051600379

040417 1227

I-2 071415

Digital File Preparation

All orders are governed by the GES Payment Policy and GES Terms & Conditions of Contract as specified in this Exhibitor Services Manual.

Forest Products Machinery & Equipment Exposition
Georgia World Congress Center
June 14 - 16, 2017

Front and Backlit Graphics

When producing artwork for front lit graphics or transparencies keep these points in mind:

- Avoid setting type in Photoshop — instead use a vector-based program (such as Adobe Illustrator) for your type. If you do use vector smart objects, save the file as an .eps or .psd to retain vector properties.
- If you plan to add effects to your type (such as drop shadows or glows), follow these steps:
 - a. Import the Illustrator type into Photoshop
 - b. Add effects to the type
 - c. Separate the effects onto a layer
 - d. Delete the type layer
 - e. Assemble the type and photo in a vector program.
- Always provide logos in a vector format.
- If you have critical PMS colors to match, provide us with a layered Photoshop file to allow for color editing.
- Always add at least 1" of bleed to your images.
- Use gradients carefully and sparingly. Gradients often "band," and little can be done to correct the problem. Look at your high res file at 100% — if you can see the banding, it WILL appear in the print. Adding 1 pt. of noise to the file may resolve the problem.

File Sizes

Please build Photoshop (raster) graphics to at least 100dpi at final size. Any combination of size/resolution that produces this result is acceptable.

(e.g. 1/4 size file @400dpi)

Here is an easy way to determine how much digital information is needed for your graphic:

- Open a new document in Photoshop
- Enter the final width and height of your graphic.
- Enter a resolution of 100 dpi

The resulting megabyte size is the approximate amount of digital information we need for best quality output.

Adobe Illustrator, InDesign, Photoshop

- Work with .eps files as much as possible. .eps files are a better quality file format than .tif files and are accepted more easily by Adobe Illustrator.
- Save a Low Res version of your files for proofing and a Hi Res file for production. Illustrator allows for seamless swapping of LR and HR files provided the images are the same dimensions.
- When saving your HR file, use the settings shown in *figure a*. This will compress the information in the file without degrading the quality. High resolution files saved with this setting present no issues for our output devices.
- If you must work with a .tif file because you are colorizing it in Illustrator, save the HR file with the LZW compression option.
- Keep all color-critical elements of your design vector whenever possible. Don't send the layered Photoshop unless you need critical color corrections. If you want to add a Photoshop effect to a logo or color critical text: set the text in Illustrator or keep the logo vector, create the desired effect in Photoshop, then link the Photoshop file into Illustrator under the color critical vector art or text.
- Photoshop files with text or vector smart objects need to be saved out as .eps or .psd to retain vector properties.

Placed Images

Provide placed images at 100dpi at 100% of final size as a .tif (LZW compression) or .psd. Embedding images in Illustrator is preferred and need to be 100dpi at final size.

Fonts

Turn all fonts to outlines or convert to paths before sending the files. If you are using a program where this is not an option, YOU MUST INCLUDE ALL FONTS with your files. OTF (open type fonts). are preferred.

Vinyl

We can only produce vinyl for type or logos from VECTOR based artwork. DO NOT send PowerPoint files, .gifs, .jpps, .pdfs or raster-based images output to vinyl.

Remember

- You MUST add bleed to your photographic images.
- Backlit graphics are held in place with velcro or with a frame—place type and critical images at least 1" from all edges to avoid this dead space (see diagram below).
- You MUST provide PMS colors. We are not responsible for accurate reproduction of your logo or corporate colors if PMS matches are not provided.
- Please make certain that your scans are clean (free of dust, dirt, and scratches) BEFORE you send them for production. Deadlines and time constraints do not allow us to check all your images for quality. We must assume the images you provide are the highest quality available to you. To check for quality, look at your Photoshop files at 100% enlargement. If you can see dirt and scratches, they will appear on your final output. Use the rubber stamp tool (clone stamp tool) to eliminate these imperfections.

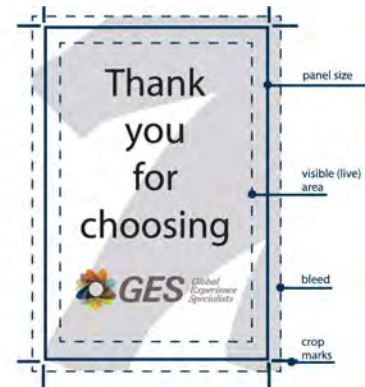

figure a.

040417 1227
I-2 071415

Graphics and Signage Order Form

All orders are governed by the GES Payment Policy and GES Terms & Conditions of Contract as specified in this Exhibitor Services Manual.

Forest Products Machinery & Equipment Exposition
 Georgia World Congress Center
 June 14 - 16, 2017

Discount Deadline Date:
 May 22, 2017

Company Name _____ Email _____ Phone Number _____ Booth Number _____

Order graphics and **upload artwork files** directly online, click here: <https://e.ges.com/051600379/signs/esm>

Graphics and Signage

Item Code	Description	Discount (\$)	Regular (\$)	Qty	Tax %	Total
600534	22"W x 28"H Vertical Sign w/ Sign Holder, Double Sided	301.00	419.00		8.9	\$
600533	22"W x 28"H Vertical Sign w/ Sign Holder, Single Sided	235.00	326.00		8.9	\$
600535	72"W x 36"H Vinyl Banner (horizontal or vertical) w/ Silver Grommets, Single Sided	248.00	345.00		8.9	\$
600852	Freestanding 24"W x 84"H Vertical Ad Board w/ Cardboard Base, Double Sided	449.00	624.00		8.9	\$
600850	Freestanding 24"W x 84"H Vertical Ad Board w/ White Cardboard Base, Single Sided	276.00	384.00		8.9	\$
600853	Freestanding 38"W x 84"H Vertical Ad Board w/ White Cardboard Base, Double Sided	586.00	814.00		8.9	\$
600851	Freestanding 38"W x 84"H Vertical Ad Board w/ White Cardboard Base, Single Sided	414.00	575.00		8.9	\$
601099	Printed Cardboard Base for Freestanding Boards	27.00	37.50		8.9	\$

Total and Sign: Return to Fax: 866.329.1437 • International Fax: 702.263.1520

Please Sign

X

Authorized Signature

Authorized Name - Please Print

Date

I agree in placing this order that I have accepted GES Payment Policy and GES Terms & Conditions of Contract, including authorization for GES to retain personal information to better serve my need for GES services at future events.

Total Payment Enclosed

\$

040417 051600379

I-1 112816

Standard Graphics

38" Ad Board



600851 Freestanding 38"W x 84"H Vertical Ad Board w/ White Cardboard Base, Single Sided (includes cardboard base, graphic & delivery)

600853 Freestanding 38"W x 84"H Vertical Ad Board w/ White Cardboard Base, Double Sided

*Includes cardboard base, graphic and delivery.
Printed base available at additional cost.*

24" Ad Board



600850 Freestanding 24"W x 84"H Vertical Ad Board w/ White Cardboard Base, Single Sided (includes cardboard base, graphic & delivery)

600852 Freestanding 24"W x 84"H Vertical Ad Board w/ Cardboard Base, Double Sided

*Includes cardboard base, graphic and delivery.
Printed base available at additional cost.*

22" x 28" with Sign Holder



600533 22"W x 28"H Vertical Sign w/ Sign Holder, Single Sided

600534 22"W x 28"H Vertical Sign w/ Sign Holder, Double Sided

Includes sign holder rental, graphic and delivery.

6' x 3' Banner



600535 72"W x 36"H Vinyl Banner (horizontal or vertical) w/ Silver Grommets, Single Sided

*Banner is available horizontal or vertical.
Includes silver grommets.*

Material Handling/Drayage Information

All orders are governed by the GES Payment Policy and GES Terms & Conditions of Contract as specified in this Exhibitor Services Manual.

Forest Products Machinery & Equipment Exposition
Georgia World Congress Center
June 14 - 16, 2017

Benefits of Advance Shipping to the GES Warehouse

- Storage of materials for up to 30 days prior to your show.
- Delivery of shipments to your booth by your published set-up time.
- Some convention centers and hotels do not have facilities for receiving or storing freight.
- Saves valuable set-up time.

How to Ship in Advance to the GES Warehouse

- Remove all old shipping and empty storage labels.
- Fill out and attach enclosed Advance Shipping labels.
- Complete the enclosed Material Handling/Drayage Order Form.
- Remember to confirm receipt of your shipment prior to leaving for the show.
- All shipments must have a bill of lading or delivery slip showing the number of pieces, weight, and type of merchandise.
- Certified weight tickets must accompany all shipments.
- Take the time to ensure that your display and products are packed neatly and securely.
- Do not ship uncrated materials to warehouse.

How to Ship to Exhibit Site

- Consign all domestic shipments c/o GES.
- Remove all old shipping and empty storage labels.
- Fill out and attach enclosed Direct Shipping labels.
- Complete the enclosed Material Handling Information Sheet.
- All shipments must have a bill of lading or delivery slip showing the number of pieces, weight, and type of merchandise.
- Certified weight tickets must accompany all shipments.
- Take the time to ensure that your display and products are packed neatly and securely.
- If you are shipping your carpet and/or lighting truss, make sure it is loaded last so it can be unloaded first.

Freight Carriers

Select a carrier with experience in handling exhibition materials. Make sure to give your carrier explicit information as to where and when to check in. Delivery and pick up times are often out of the range of normal delivery hours, make sure your carrier is committed to meeting your target dates and times. While making shipping plans to the show, also plan for the return shipment.

Tracking Shipments

Confirm your delivery date and time with your carrier, and have all pertinent shipping information in the hands of your representative at show site. You may also want to review the return of your goods at the end of the show. GES Logistics domestic shipments can be tracked online by going to:
www.ges.com/us/services/exhibition-transportation-tools.

Get an instant quote today at https://e.ges.com/051600379/logistics_Quote

040417 051600379

R-1 012417

Estimating Material Handling Charges

Handling charges are based on the weight of the freight. Shipments are billed by the hundred weight and rounded up to the nearest hundred. Minimum per shipment may apply, see enclosed Material Handling/Drayage Order Form for details. Please prepay all shipping charges - GES cannot accept or be responsible for collect shipments. Crated and uncrated shipments must be separated and clearly identified on separate bills of lading with separate weight tickets - otherwise GES will invoice the entire load at the Uncrated rate.

- Crated - Material that is skidded, or is in any type of shipping container that can be unloaded at the dock with no additional handling required.
- Uncrated - Material that is shipped loose or pad-wrapped, and/or unskidded machinery without proper lifting bars or hooks.
- Special Handling - Defined as shipments that are loaded by cubic space and/or packed in such a manner as to require special handling, such as ground loading, side door loading, constricted space loading and designated piece loading or stacked shipments. Also included are mixed shipments and shipments without proper delivery receipts.
- Overtime Surcharges - Shows that move-in or move-out on weekends or after 4:30 PM during the weekday, may be subject to additional overtime surcharges. See enclosed Material Handling/Drayage Order Form for details.

Late Surcharges - May be charged an additional overtime surcharge

- If advance freight is received before or after the published deadline date for shipments to arrive at the warehouse. See enclosed Material Handling/Drayage Order Form for details.
- Freight shipments sent to the show after it has opened.
- Freight shipments that are received at showsite that do not meet their published date and time.
- Shipment Surcharges - A surcharge will be incurred per shipment for those that are received with incomplete information on shipping labels identifying company name and booth number and/or shipments that are left on the show floor at the end of the show with no labels and no bill of lading turned in.

Machinery Labor and Equipment

Labor and equipment for uncrating, unskidding, positioning, leveling, dismantling, re-crating, and reskidding machinery and/or equipment must be ordered separately. Place your order for this labor using the Forklift Labor Order Form. If your material requires specialized rigging equipment, please notify us promptly so that we can make arrangements. When possible, supply your own rigging equipment with shipments and pre-rig your material.

Storing Empty Containers

Properly labeled empty shipping cartons will be picked up, stored, and returned after the show. Labels are available at the GES Servicenter® or from your GES Service Executive and are for empty storage only. Depending on the size of the show, it can take from two to twelve hours to return empty crates. Do not store any items in crates marked "empty." GES has no liability for damage to crates or items sent to empty storage in crates.

Outgoing Shipments

An OMHF (Outbound Material Handling Form / Bill of Lading) must accompany all outgoing shipments. Shipping information, outbound forms and labels will be available at the GES Servicenter®. Exhibitors selecting non-official carriers will need to make their own arrangements for pickup. Make sure that someone from your company will be on-site to oversee the outbound shipment of your display and product.

040417 051600379

R-1 012417

Measure of Damage

- Liability - GES is liable for loss or damage to your goods only if the loss or damage is caused by GES negligence.
- Sole Relief - If found liable for any loss, GES' sole and exclusive maximum liability for loss or damage to Customer's goods is limited to \$.50 (USD) per pound with a maximum liability of \$100 (USD) per container, or \$1,500.00 (USD) per shipment, whichever is less.

Insurance

All of your goods should be insured by your own insurance policy. Although we do our best to handle your goods as our own, there are many variables in shipping and handling that can affect your exhibit and products. GES has published GES Terms and Conditions of Contract that are in this exhibitor service manual. Please read them carefully. It is recommended that your goods be insured.

Work Zone





Customer acknowledges that the show site and surrounding areas are active work zones. Customer, its agents, employees and representatives are present at their own risk.



Save 10% on Material Handling with GES Transportation Plus.

GES is your one stop shop for event and trade show transportation. As the Official Services Provider, we can offer you competitive pricing and a seamless shipping experience along with these Transportation Plus benefits:



-  10% off material handling
-  GES on-site support professionals
-  24/7 online shipment tracking: <http://www.ges.com/us/logistics/tools>
-  Consolidated show invoice
-  Fully integrated storage and shipping solutions



Order your round-trip shipping today to qualify for 10% off material handling fees.

Get an instant quote today at: https://e.ges.com/051600379/logistics_quote

Discount does not apply to shipments that are considered small packages, local or shipments over 5,000 lbs.

Material Handling/Drayage Order Form

All orders are governed by the GES Payment Policy and GES Terms & Conditions of Contract as specified in this Exhibitor Services Manual.

Forest Products Machinery & Equipment Exposition
 Georgia World Congress Center
 June 14 - 16, 2017

Discount Deadline Date:
 May 22, 2017

Company Name _____ Email _____ Phone Number _____ Booth Number _____



Easy Ordering Tips:

- Material Handling is the unloading and delivery of exhibit freight to the exhibitor's booth on the show floor. Material handling charges will be invoiced to you at show site for any freight unloaded and delivered. Use this form to plan, estimate costs and pre-order this service.
- Crated Material is skidded, or is in any type of shipping container that can be unloaded at the dock with no additional handling required.
- Special Handling is defined as shipments that are loaded by cubic space and/or packed in such a manner as to require special handling, such as ground loading, side door loading, constricted space loading and designated piece loading or stacked shipments. Also included are mixed shipments and shipments without proper delivery receipts.
- Uncrated Material is shipped loose or pad-wrapped, and/or unskidded machinery without proper lifting bars or hooks. The advance receiving warehouse cannot receive uncrated shipments.
- *Overtime Charge (inbound/Outbound) 25% surcharge will apply to all shipments.

Step 1. Review Freight Material Handling Rates and Information

Advance Shipment to Warehouse (200 lbs. minimum per shipment)

	Crated	Special Handling
Straight Time In / Straight Time Out	\$23.10 cwt	\$35.00 cwt

Advance Shipments to Warehouse Dates:

Tue, May 9, 2017: Advance shipments may begin arriving at warehouse.
Wed, Jun 7, 2017: Last day for shipments to arrive at warehouse.

Direct Shipment to Show Site (200 lbs. minimum per shipment)

	Crated	Special Handling	Uncrated
Straight Time In / Straight Time Out	\$21.10 cwt	\$35.00 cwt	\$35.00 cwt

Direct Shipments to Show site Dates:

Sun, Jun 11, 2017: Direct shipments may begin arriving at exhibit site after 12:00 PM.
Tue, Jun 13, 2017: Last day for shipments to arrive at exhibit site by 5:00 PM.
***Please reference targeted floor plan**

Small Package

Cartons and envelopes received without documentation will be delivered without guarantee of piece count or condition. Maximum weight is 50 lbs. for the first shipment, per delivery. This includes UPS and Federal Express shipments. All shipments received via air carrier that do not fall under the small package category may be subject to special handling charges. First shipment of small packages will be charged \$41.50. Each additional package will be charged \$12.00.

Step 2. Estimate Order

Small Packages

___ 1 ___ 1st Small Package Shipment x \$41.50 = _____ Total
 ___ # of additional packages (each) x \$12.00 = _____ Total

SSC

040417 051600379

R-2 031617

What is "Special" Handling?

Special Handling applies to shipments that are loaded in such a manner as to require additional labor and handling to unload or load out. An additional fee beyond the standard crated rate will apply.

Special Handling Includes:

Ground Loading

- Vehicles that are not dock height, preventing the use of loading docks.
- When docks are not readily available.
- When convention facility has no dock space

Side Door Loading

- Shipments tendered for delivery in such a manner as to prevent access from the rear of the trailer.

Constricted Space Loading

- Freight loaded "high and tight" or down one side as to make shipments not readily available.

Designated Piece Loading

- When a trailer must be loaded in a particular sequence to ensure fit.

Stacked, Cubed-out, or Loose Shipments

- Shipments loaded in such a manner requiring items to be removed to ground level for delivery to booth.
- Items that would need to be unstacked/stacked, unstrapped/strapped, or loadbars to be removed/installed during the unload or load out process.

Multiple Shipments

- Shipments that are loaded mixed on the truck, failing to maintain shipment integrity and/or have multiple delivery areas.

Mixed Shipments

- Pieces for separate shipments that are loaded mixed throughout the delivery vehicle, or shipments of crated and uncrated goods where the percentage of uncrated is minimal and does not warrant full uncrated rate for shipment.

Improper Delivery Receipts

- Shipments that arrive without individual Bill of Lading. Possible examples might include: UPS, FedEx, company trucks, privately-owned vehicles.

Uncrated Shipments

- Material that is shipped loose or pad-wrapped, and/or unskidded machinery without proper lifting bars or hooks.

Special Handling Examples:



Side Door Loading



Constricted Space Loading



Stacked Shipments



Uncrated Shipment



Multiple Shipments

Use these shipping labels as they will expedite handling. Copies of these labels are acceptable if additional labels are needed.



FROM:



FROM:

Please print this label on a color printer if possible



TO:

Full Exhibiting Company Name at Show

Forest Products Machinery & Equipment Exposition

Name of Exhibition 051600379

BOOTH NUMBER

C/O GES
RAC Logistic LLC
4351 Thurman Road
Conley, GA 30288 USA

Shipment Should Arrive on or Between:
Tuesday, May 9, 2017 - Wednesday, June 7, 2017

Certified Weight Tickets are required for all Shipments. Drivers must check in by 2:00 PM to be guaranteed same day unloading. Warehouse receiving hours are Monday - Friday, 8:00 AM - 4:30 PM; Closed 12:00 PM - 1:00 PM & Holidays.

Carrier _____
Number _____ of _____ pieces



TO:

Full Exhibiting Company Name at Show

Forest Products Machinery & Equipment Exposition

Name of Exhibition 051600379

BOOTH NUMBER

C/O GES
RAC Logistic LLC
4351 Thurman Road
Conley, GA 30288 USA

Shipment Should Arrive on or Between:
Tuesday, May 9, 2017 - Wednesday, June 7, 2017

Certified Weight Tickets are required for all Shipments. Drivers must check in by 2:00 PM to be guaranteed same day unloading. Warehouse receiving hours are Monday - Friday, 8:00 AM - 4:30 PM; Closed 12:00 PM - 1:00 PM & Holidays.

Carrier _____
Number _____ of _____ pieces



Please print this label on a color printer if possible

Use these shipping labels as they will expedite handling. Copies of these labels are acceptable if additional labels are needed.



FROM:



FROM:

Please print this label on a color printer if possible



TO:

Full Exhibiting Company Name at Show

Forest Products Machinery & Equipment Exposition

Name of Exhibition

051600379

BOOTH NUMBER

C/O GES
Georgia World Congress Center
285 Andrew Young Intl Blvd NW
Atlanta, GA 30313 USA

Shipment Should Arrive on or Between:

Sunday, June 11, 2017 after 12:00 PM - Tuesday, June 13, 2017 by 5:00 PM

*Please reference targeted floor plan

Certified Weight Tickets are Required for all shipments. Drivers must check in by 2:00 PM to be guaranteed same day unloading.

Carrier _____
Number _____ of _____ pieces



TO:

Full Exhibiting Company Name at Show

Forest Products Machinery & Equipment Exposition

Name of Exhibition

051600379

BOOTH NUMBER

C/O GES
Georgia World Congress Center
285 Andrew Young Intl Blvd NW
Atlanta, GA 30313 USA

Shipment Should Arrive on or Between:

Sunday, June 11, 2017 after 12:00 PM - Tuesday, June 13, 2017 by 5:00 PM

*Please reference targeted floor plan

Certified Weight Tickets are Required for all shipments. Drivers must check in by 2:00 PM to be guaranteed same day unloading.

Carrier _____
Number _____ of _____ pieces



Please print this label on a color printer if possible

Request for Pre-Printed Outbound Material Handling Release/Labels

All orders are governed by the GES Payment Policy and GES Terms & Conditions of Contract as specified in this Exhibitor Services Manual.

Forest Products Machinery & Equipment Exposition
Georgia World Congress Center
June 14 - 16, 2017

Form Deadline Date:
May 22, 2017



Form Tips:

- This form is used to gather your shipping information for the destination of your freight after the show closes. This document is not a Bill of Lading (BOL).
- Save time checking out by completing this form for pre-printed outbound Material Handling documents and outbound address labels.
- In order to provide this service, please submit this form by May 22, 2017.
- Want an easier way? Fill out this information online and submit:
<https://e.ges.com/051600379/prePrint/esm>

Step 1. Tell us the location of materials for pickup (show site address)

Company/Consignee	Attention			
285 Andrew Young Intl Blvd NW	Atlanta	GA	30313	USA
Street Address	City	State	Zip/Postal Code	Country
Phone	Fax		Booth Number	

Step 2. Tell us the location where freight should be sent

Shipping Destination 1:

Number of Labels Needed:

Company/Consignee	Attention			
Street Address	City	State	Zip/Postal Code	Country
Phone	Fax		Booth Number	

Shipping Destination 2:

Number of Labels Needed:

Company/Consignee	Attention			
Street Address	City	State	Zip/Postal Code	Country
Phone	Fax		Booth Number	

Showsite Instructions: Once your shipment is packed and ready to be picked up, please return the outbound material handling release form to the GES Servicercenter®. Verify the piece count, weight, and that the signature is on the outbound material handling release form prior to shipping out. Shipments without paperwork turned in will be returned to GES Warehouse or forced onto another carrier at Exhibitor's expense.

GES does not accept responsibility for any exhibitor property left on the show floor unattended at any time for any reason.

Measure of Damage: If found liable for any loss, GES' sole and exclusive maximum liability for loss or damage to Customer's Goods is limited to \$.50 (USD) per pound with a maximum liability of \$100.00 (USD) per container, or \$1,500.00 (USD) per shipment, whichever is less.

Review and Return: Return to Fax: 866.329.1437 • International Fax: 702.263.1520

040417 051600379

R-3 042716

Freight Service Questionnaire

All orders are governed by the GES Payment Policy and GES Terms & Conditions of Contract as specified in this Exhibitor Services Manual.

Forest Products Machinery & Equipment Exposition
Georgia World Congress Center
June 14 - 16, 2017

Form Deadline Date:
May 22, 2017

Company Name

Email

Phone Number

Booth Number



Required Information For Exhibitors with Freight Shipments:

- This form should be returned by all exhibitors shipping freight.
- By returning this form we can better plan and prepare for incoming freight.
- Want an easier way? Fill out this information online and submit:
<http://e.ges.com/051600379/freightQuestionnaire/esm>

1. Estimate total number of pieces being shipped:

- _____ Crated
_____ Uncrated
_____ Machinery
_____ Total

2. Indicate total number of trucks in each category that you will use:

- _____ Van Line
_____ Common Carrier
_____ Flatbed
_____ Co. Truck
_____ Overseas Container

3. List carrier name(s):

4. If using a Customs Broker, please print name:

Phone Number:

5. Print the name of person in charge of your move-in:

Phone Number:

6. What is the minimum number of days to set your display?

7. What is the weight of the single heaviest piece that must be lifted?
_____ lbs.

8. What is the total weight of your exhibit or equipment being shipped?
_____ lbs.

9. Is there any special handling equipment required to unload your exhibit materials, i.e. extended forklift blades, special slings, lifting bars. etc.?

It is the responsibility of the exhibitor to provide proper special handling instructions, and to ensure goods are packaged appropriately for shipment and movement by heavy equipment. Failure to provide special handling instructions will result in the elimination of any liability for loss or damage by GES.

Direct Shipments Only

1. What date and time are you scheduling your shipment(s) to arrive on-site?

040417 051600379

R-7 032316

Review and Return: Return to Fax: 866.329.1437 • International Fax: 702.263.1520

Marshaling Yard and Direct Deliveries Information

All orders are governed by the GES Payment Policy and GES Terms & Conditions of Contract as specified in this Exhibitor Services Manual.

Forest Products Machinery & Equipment Exposition
Georgia World Congress Center
June 14 - 16, 2017

Tips For New Exhibitors



Tips

What is a marshaling yard? The Marshaling Yard is an offsite location where trucks are checked in and held until dock space for unloading becomes available onsite.

Why is a marshaling yard used? Large shows use a marshaling yard to ease vehicle congestion and to ensure the unloading process runs smoothly.

Savings



Save

- There is no charge for this Marshaling Yard service.
- Avoid late charges by checking the Show Schedule for arrival dates and times.

Marshaling Yard Site Address:

362 Ivan Allen Jr. Blvd. NW
Atlanta, GA 30313
USA

Marshaling Yard Process

It is important that you advise your carrier of this Marshaling Yard information to better facilitate your direct shipment to showsite.

- All delivering carriers and privately owned vehicles must check in at the Marshaling Yard prior to show site deliveries. All inbound shipments will be weighed at the Marshaling Yard to obtain the gross or heavy weight.
- All inbound shipments must be accompanied by a certified weight certificate and Bill of Lading.
- At the Marshaling Yard, drivers will be assigned a number and will be dispatched to the appropriate dock at Georgia World Congress Center as space is available. Waiting time at the Marshaling Yard should be anticipated by your carrier. Every effort is made to keep this waiting time at a minimum. However, the waiting time depends on many factors, including the number of vehicles arriving to unload/load, the type of loads being unloaded at the Georgia World Congress Center, the number of booths on a truck, etc.
- After unloading, all vehicles must return to the Marshaling Yard with a completed copy of the GES Receiving Report to be weighed to obtain the light weight. This determines the total weight of your shipment. Drivers who fail to return to weigh-out may face having their shipment billed at the heavy weight.
- All drivers are expected to adhere to GES' policies and procedures with respect to the loading and unloading of trailers.

Contact us for Assistance with your Inbound Freight Arrangements



Contact

- Chat with us <http://www.ges.com/chat>
- Contact us online: <https://e.ges.com/051600379/contactus/esm>

051600379

040417

R-9 010917

Target Move-In and Freight Information

All orders are governed by the GES Payment Policy and GES Terms & Conditions of Contract as specified in this Exhibitor Services Manual.

Forest Products Machinery & Equipment Exposition
Georgia World Congress Center
June 14 - 16, 2017



Form Tips:

- A targeted move-in is a designated day and time for arrival of a particular exhibitor or exhibit area depending on their location within the facility, according to a target map/floor plan.
- Your assigned target is the date and time that your truck must check into the marshalling yard. Once the marshalling yard sends your truck to the building to start unloading your company's truck, your exhibit/samples are taken directly to your booth space.
- As long as your truck arrives on or before your target time on your targeted date, there is no additional off-target charge.
- Find your targeted/scheduled time for move-in by reviewing the Targeted Floor Plan provided by the show organizer for target move-in times. This is for the move-in of your exhibit only. Your product can arrive at a later date.



Attention

Attention:

- All inbound exhibit material and equipment is specifically targeted by booth number.
- Please refer to target assignments contained in this section.
- Do not allow your carrier to block your on-target freight with off-target freight as the entire load may be rescheduled.
- Every attempt will be made to accommodate all inbound deliveries within their targeted day. However, there can be no guarantees with respect to absolute delivery dates and times.
- We recommend scheduling installation labor to begin the day after your inbound target assignment.
- It remains the exhibitors' responsibility to ensure that their freight is loaded to accommodate the inbound target assignments. Please plan carefully.
- Off-target freight and equipment may be refused and/or rescheduled. Please refer to Target Schedule.

Important Reminders



Reminder

- A target assignment is the point at which direct deliveries may begin checking in. It is not the point at which set-up should be scheduled.
- Freight shipped through our warehouse will be delivered prior to the beginning of your assigned target date and time.
- Route your shipments carefully. Utilize only carriers who provide bills of lading and can be contacted at any point in time.
- Insure your material from the time it leaves your facility until it is returned.
- Do not allow your carrier to block your on-target freight with off-target freight as the entire load may be rescheduled.

Correct:



Incorrect:



Questions?



Contact

- Chat with us <http://www.ges.com/chat>
- Contact us online: <https://e.ges.com/051600379/contactus/esm>

Request for Variance to Assigned Target Time

All orders are governed by the GES Payment Policy and GES Terms & Conditions of Contract as specified in this Exhibitor Services Manual.

Forest Products Machinery & Equipment Exposition
Georgia World Congress Center
June 14 - 16, 2017

Form Deadline Date:
May 22, 2017

Company Name

Booth Number

Contact Name

Phone Number

Fax Number

Email Address

Address

City

State

Zip

Country

Current Assigned Target Date/Time

New Requested Target Date/Time

Reason for request:

Important information

- All change request forms due by May 22, 2017.
- This form will be reviewed after the deadline date and you will be contacted with the appropriate approval if request is granted.
- Please send completed form to Eric Birdsell via email at EBirdsell@ges.com or fax at (770) 372-1658.

Questions?



- Chat with us <http://www.ges.com/chat>
- Contact us online: <https://e.ges.com/051600379/contactus/esm>

R-23 010617 040417 051600379

R-23 010617

Cartload Service Order Form

All orders are governed by the GES Payment Policy and GES Terms & Conditions of Contract as specified in this Exhibitor Services Manual.

Forest Products Machinery & Equipment Exposition
 Georgia World Congress Center
 June 14 - 16, 2017

Form Deadline Date:
 May 22, 2017

Company Name _____ Email _____ Phone Number _____ Booth Number _____

Vehicles That Qualify for Cartload - Under One (1) Ton



Sedan



Van



SUV



Small Pickup

Important Reminders

-  **Reminder**
- Maximum Weight 200 lbs to qualify for this service.
- Freight that is too large or heavy will be charged Material Handling rates
- One (1) round trip allowed per booth.

Cartload Freight Services for Unloading Small Passenger Vehicles

- To facilitate the move-in and move-out of Exhibitors with small exhibit material shipments, cartload service is available for one (1) laborer with one (1) pushcart, for one (1) round trip.
- This service is for those who have small hand carry items all of which must fit on a 2' x 6' push cart for one (1) round trip. If you arrive with a truck or van (one 1-ton and over), trailer, or truck with trailer filled with exhibit material you will not qualify for this service and will be redirected.
- A cartload is eight (8) pieces or less, weighing less than 200 lbs. total. one (1) round trip allowed per booth.
- Your vehicle must unload on the receiving dock of the exhibit hall. GES personnel will direct vehicles. The cart is not authorized to enter or go to any parking structure. There must be two (2) people with the vehicle; one person to go with your product to the booth space and one person to remove your vehicle from the unloading area to the parking area.
- Freight that is too large or heavy will be charged Material Handling/Drayage rates. No personal trucks (one 1-ton and over), no rental trucks, trailers or bobtails will be unloaded through cartload service.
- To receive this service, go to the Marshaling Yard and watch for the Cartload Service signs.
- Pre-orders will receive preferential service at show site, you may also order this service at the GES Servicenter.

Cartload Services

Item Code	Description	Rate (\$)	# of Trips	Total
200506	Cartload Service, Straight Time	74.50	1	\$
200506	Cartload Service, Over Time	96.75	1	\$

Total and Sign: Return to Fax: 866.329.1437 • International Fax: 702.263.1520

Please Sign

X

Authorized Signature

Authorized Name - Please Print

Date

I agree in placing this order that I have accepted GES Payment Policy and GES Terms & Conditions of Contract, including authorization for GES to retain personal information to better serve my need for GES services at future events.

Total Payment Enclosed

\$

051600379 040417

R-14 031317

Vehicle Placement Order Form

All orders are governed by the GES Payment Policy and GES Terms & Conditions of Contract as specified in this Exhibitor Services Manual.

Forest Products Machinery & Equipment Exposition
 Georgia World Congress Center
 June 14 - 16, 2017

Form Deadline Date:
 May 22, 2017

Company Name _____ Email _____ Phone Number _____ Booth Number _____



Easy Ordering Tips:

- Displaying a vehicle at the show? Please be as detailed as possible with the information you provide.
- GES charges a round-trip fee, per vehicle, to place a vehicle on the trade show floor. This will apply to rolling stock, self-propelled, towed and/or pushed vehicles/machinery. GES will receive equipment at show site and deliver to the Exhibitor booth. We will also handle the outboard as an inclusive service
- For dual axle vehicles measure the distance from the front wheel to between the back wheels.

Important Rules and Regulations



- The City Fire Marshal requires that battery cables must be disconnected, place a protective covering under the vehicle, gas tank must either be taped shut or have a lockable gas cap and contain a full tank of fuel. Exhibitor is responsible for checking local Fire Marshal rules and regulations for additional requirements.
- Your presence is Required! Vehicle Placement must be Exhibitor supervised. GES assumes no liability for loss, damage or bodily injury arising out of the placement of Exhibitor's vehicle. Exhibitor assumes the responsibility and an liability arising therefrom, for the work performed by union labor under Exhibitor's supervision.
- Watch your toes! Exhibitor(s) must stay clear during movement of vehicle.

Step 1. Provide Vehicle Information

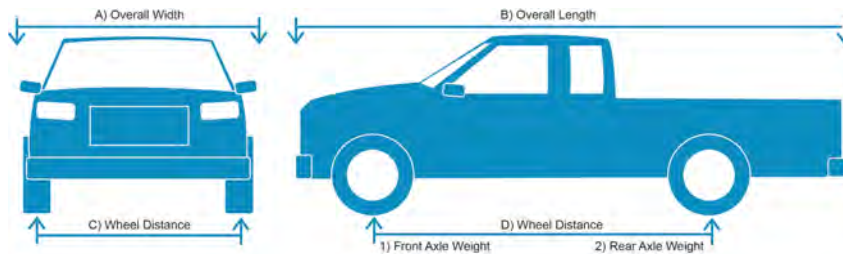

Vehicle Description*	A) Overall Width	B) Overall Length	Total Sq. Ft.	C) Wheel Distance	D) Wheel Distance	1) Front Axle Weight	2) Rear Axle Weight	Total Weight
1.								
2.								
3.								

Exhibitor will be at show site on _____, 20_____, between _____ and _____ AM/PM to assist in the movement of the vehicle.

* Please attach separate sheet for more than 3 vehicles.

Step 2. Vehicle Placement Services (Round Trip)

Item Code	Description	Rate (\$)	# of vehicles	Total
200507	Vehicle Placement Round-Trip, per vehicle	354.50		\$

Total and Sign: Return to Fax: 866.329.1437 • International Fax: 702.263.1520

Please Sign

X

Authorized Signature

Authorized Name - Please Print

Date

I agree in placing this order that I have accepted GES Payment Policy and GES Terms & Conditions of Contract, including authorization for GES to retain personal information to better serve my need for GES services at future events.

Total Payment Enclosed

\$

040417 051600379

R-15 062716

Installation and Dismantling Order Form

All orders are governed by the GES Payment Policy and GES Terms & Conditions of Contract as specified in this Exhibitor Services Manual.

Forest Products Machinery & Equipment Exposition
Georgia World Congress Center
June 14 - 16, 2017

Discount Deadline Date:
May 22, 2017

Company Name	Email	Phone Number	Booth Number
Show Site Contact	Show Site Email	Show Site Phone Number	



Easy Ordering Tips:

- Please complete this form for all display labor needed. To determine if you need display labor, please read the show site work rules carefully.
- Straight Time (ST): Monday through Friday from 8:00 AM to 4:30 PM.
- Overtime (OT): All other times Monday through Friday. All day Saturday & Sunday.
- Double Time (DT): All day Holidays.

Step 1. Order Labor

Item Code	Description	Discount (\$)	Regular (\$)	Show Site (\$)	X # Workers	X # Hours	= Total
705000	Install & Dismantle, ST Move In	90.00	113.00	135.00			\$
705000	Install & Dismantle, ST Move Out	90.00	113.00	135.00			\$
705000	Install & Dismantle, OT Move In	135.00	169.00	203.00			\$
705000	Install & Dismantle, OT Move Out	135.00	169.00	203.00			\$

Hate math? Let Espresso calculate your rates: <https://e.ges.com/051600379/labor/esm>

Step 2. Please Indicate Service



What is GES Supervision? An exhibitor chooses GES Supervised when they do not want to be present when the work is completed. On most shows and services, there is a minimum surcharge for the professional supervision. Remember, when an exhibitor chooses this option, they do not need to schedule a date and time for services to be completed.

Option 1 (A 25% (\$ 50.00 minimum) surcharge will be added)

- GES Supervised (OK to proceed without exhibitor.)

Please complete Key Information form,
click here: <https://e.ges.com/051600379/laborchecklist/esm>
GES will supervise labor to:

- Unpack and install display before Exhibitor arrival at show site.
- Dismantle and pack the display after show closing.

- Subject to terms and conditions of all GES policies, including terms and conditions of contract, including but not limited to subparagraph VII, b., Labor.
- A 25% (\$ 50.00 minimum) surcharge will be added to the labor rates above for this professional supervision.

Location of Booth/Dimension of Booth: Use the Booth Layout Form to represent your booth, indicate from each boundary how you would like your booth placed.

040417 051600379

L-1 011117

Form Continues on Next Page

Installation and Dismantling Order Form

All orders are governed by the GES Payment Policy and GES Terms & Conditions of Contract as specified in this Exhibitor Services Manual.

Company Name _____ Email _____ Phone Number _____ Booth Number _____



What is Exhibitor Supervision? An exhibitor chooses Exhibitor Supervised so they are able to instruct the laborer. The exhibitor is required to be in the booth and there are no supervision fees. Scheduling a date and time is necessary for this choice.

Option 2

- Exhibitor Supervised
 - Indicate workers needed for installation and dismantling
 - GES assumes no liability for loss, damage or bodily injury arising out of the installation and/or dismantling of Exhibitor's property by GES provided union labor. Exhibitor assumes the responsibility and any liability arising therefrom, for the work performed by union labor under Exhibitor's supervision. Exhibitors must stay clear during movement of freight.

GES is responsible for the following type of booth:

- Pop-Up Two Story Custom
- Other: _____

Please estimate the number of workers and hours per worker needed for installation. Invoice will be calculated according to actual hours worked, relative to the original estimate and based upon the date received. Additional labor required will be calculated and invoiced at the show site rate.

Move In

Schedule Dates	Schedule Start Time	Schedule End Time	Number of Workers
MM/DD/YR	AM PM	AM PM	
MM/DD/YR	AM PM	AM PM	
MM/DD/YR	AM PM	AM PM	

Move Out

Schedule Dates	Schedule Start Time	Schedule End Time	Number of Workers
MM/DD/YR	AM PM	AM PM	
MM/DD/YR	AM PM	AM PM	
MM/DD/YR	AM PM	AM PM	

Important Information

Starting time can be guaranteed only when labor is requested for the start of the working day. All exhibit labor scheduled at the start of the working day will be dispatched to booth space. For all other starting times, check in at the labor desk one-half (½) hour before time requested. Labor cancelled without a 24 hour notice shall be charged a one (1) hour cancellation fee per worker. If Exhibitor fails to use the workers at the time confirmed, a one (1) hour "No-Show" charge per worker will apply.

The minimum charge for labor is one (1) hour per worker. Labor thereafter is charged in half (½) hour increments. Gratuities in any form, including cash, gifts, or labor hours for work not actually performed are prohibited by GES. GES requires the highest standards of integrity from all employees. Please call our confidential Always Honest hotline at 866.225.8230 to report fraudulent or unethical behavior. All rates are subject to change if necessitated by increased labor and material costs.

Total and Sign: Return to Fax: 866.329.1437 • International Fax: 702.263.1520

Please Sign

X _____
Authorized Signature

Authorized Name - Please Print Date

I agree in placing this order that I have accepted GES Payment Policy and GES Terms & Conditions of Contract, including authorization for GES to retain personal information to better serve my need for GES services at future events.

Total Payment Enclosed

\$

L-1 110416 040417 051600379

Forklift Order Form

All orders are governed by the GES Payment Policy and GES Terms & Conditions of Contract as specified in this Exhibitor Services Manual.

Forest Products Machinery & Equipment Exposition
Georgia World Congress Center
June 14 - 16, 2017

Discount Deadline Date:
May 22, 2017

Company Name	Email	Phone Number	Booth Number
Show Site Contact	Show Site Email	Show Site Phone Number	



Easy Ordering Tips:

- In-booth forklift and labor may be required to assemble displays or when uncrating, positioning, and reskidding equipment and machinery.
- A forklift is required for moving equipment and materials weighing 200 pounds or more.
- If you require a forklift, a crew will be assigned consisting of a forklift with an operator.
- Please see Labor Information form for additional requirements regarding labor.
- Don't forget to order labor for Move In and Move Out.
- Straight Time (ST): Monday through Friday from 8:00 AM to 4:30 PM.
- Overtime (OT): All other times Monday through Friday. All day Saturday & Sunday.
- Double Time (DT): All day Holidays.

Step 1. Order Labor

Forklift with Operator, Per Hour

Item Code	Description	Discount (\$)	Regular (\$)	Show Site (\$)	X # Crews	X # Hours	= Total
705200	5,000#, ST Move In	147.00	147.00	147.00			\$
705200	5,000#, ST Move Out	147.00	147.00	147.00			\$
705200	5,000#, OT Move In	220.50	220.50	220.50			\$
705200	5,000#, OT Move Out	220.50	220.50	220.50			\$
705202	10,000#, ST Move In	163.00	163.00	163.00			\$
705202	10,000#, ST Move Out	163.00	163.00	163.00			\$
705202	10,000#, OT Move In	244.50	244.50	244.50			\$
705202	10,000#, OT Move Out	244.50	244.50	244.50			\$
705204	15,000#, ST Move In	187.00	187.00	187.00			\$
705204	15,000#, ST Move Out	187.00	187.00	187.00			\$
705204	15,000#, OT Move In	280.50	280.50	280.50			\$
705204	15,000#, OT Move Out	280.50	280.50	280.50			\$

Equipment with Operator, Per Hour

Item Code	Description	Discount (\$)	Regular (\$)	Show Site (\$)	X # Crews	X # Hours	= Total
705270	Versalift, 35,000#, ST Move In	229.00	229.00	229.00			\$
705270	Versalift, 35,000#, ST Move Out	229.00	229.00	229.00			\$
705270	Versalift, 35,000#, OT Move In	343.50	343.50	343.50			\$
705270	Versalift, 35,000#, OT Move Out	343.50	343.50	343.50			\$

Hate math? Let Espresso calculate your rates: <https://e.ges.com/051600379/labor/esm>

051600379

040417

T-1 030917

All orders are governed by the GES Payment Policy and GES Terms & Conditions of Contract as specified in this Exhibitor Services Manual.

Company Name _____ Email _____ Phone Number _____ Booth Number _____

Step 2. Labor Information



What is Exhibitor Supervision? An exhibitor chooses Exhibitor Supervised so they are able to instruct the laborer. The exhibitor is required to be in the booth and there are no supervision fees. Scheduling a date and time is necessary for this choice.

- Exhibitor Supervised (Do Not Proceed)
Exhibitor will supervise.
 - Indicate workers needed for installation and dismantling
 - GES assumes no liability for loss, damage or bodily injury arising out of the installation and/or dismantling of Exhibitor's property by GES provided union labor. Exhibitor assumes the responsibility and any liability arising therefrom, for the work performed by union labor under Exhibitor's supervision. Exhibitors must stay clear during movement of freight.

- GES is responsible for the following type(s) of work:
- Uncrating
 - Unskidding
 - Positioning
 - Leveling
 - Dismantling
 - Recrating
 - Reskidding

Additional labor will be assigned if necessary.

Step 3. Schedule In Booth Forklift Labor

Starting time can be guaranteed only when labor is requested for the start of the working day. All exhibit labor scheduled at the start of the working day will be dispatched to booth space. Confirm labor and forklifts by 2:30 PM the day before date requested. Please have a representative pick up the crew at the labor desk and supervise the work to be done. Upon completion, the Exhibitor's representative will return the crew to the labor desk and approve the work order. Equipment and labor cancelled without a 24 hour notice shall be charged a one (1) hour cancellation fee per worker and forklift. If Exhibitor fails to use the workers and equipment at the time confirmed, a one (1) hour cancellation fee per worker and forklift will apply.

The minimum charge for labor is one (1) hour per worker and equipment. Labor thereafter is charged in half (½) hour increments per worker and equipment. Gratuities in any form, including cash, gifts, or labor hours for work not actually performed are prohibited by GES. GES requires the highest standards of integrity from all employees. Please call our confidential Always Honest hotline at 866.225.8230 to report fraudulent or unethical behavior. All rates are subject to change if necessitated by increased labor and material costs.

Please estimate the number of workers and hours per worker needed for installation. Invoice will be calculated according to actual hours worked, relative to the original estimate and based upon the date received. Additional labor required will be calculated and invoiced at the show site rate.

Move In

Schedule Dates	Schedule Start Time	Schedule End Time	Number of Lifts/Workers
MM/DD/YR	AM PM	AM PM	
MM/DD/YR	AM PM	AM PM	

Schedule Dates	Schedule Start Time	Schedule End Time	Number of Lifts/Workers
MM/DD/YR	AM PM	AM PM	
MM/DD/YR	AM PM	AM PM	

Move Out

Schedule Dates	Schedule Start Time	Schedule End Time	Number of Lifts/Workers
MM/DD/YR	AM PM	AM PM	
MM/DD/YR	AM PM	AM PM	

Schedule Dates	Schedule Start Time	Schedule End Time	Number of Lifts/Workers
MM/DD/YR	AM PM	AM PM	
MM/DD/YR	AM PM	AM PM	

Total and Sign: Return to Fax: 866.329.1437 • International Fax: 702.263.1520

Please Sign

X

Authorized Signature

Authorized Name - Please Print

Date

I agree in placing this order that I have accepted GES Payment Policy and GES Terms & Conditions of Contract, including authorization for GES to retain personal information to better serve my need for GES services at future events.

Total Payment Enclosed

\$

040417 051600379

T-1 030917



Crane/Versa Lift/Rigging Labor Order Form

All orders are governed by the GES Payment Policy and GES Terms & Conditions of Contract as specified in this Exhibitor Services Manual.

Forest Products Machinery & Equipment Exposition
 Georgia World Congress Center
 June 14 - 16, 2017

Discount Deadline Date:
 May 22, 2017

Company Name	Email	Phone Number	Booth Number
Show Site Contact	Show Site Email	Show Site Phone Number	



Easy Ordering Tips:

- Exhibitors requiring forklifts to assemble displays or when uncrating, unskidding, positioning and reskidding equipment and machinery will need to estimate their needs below.
- If you require a Versa Lift, a crew will be assigned consisting of a Versa Lift with an operator and 1 worker.
- A crane usually includes a foreman, a rigger, and an operator. Crew size is at the discretion of the official service provider. All labor must be supplied by GES.
- Don't forget to order labor for Move In and Move Out.
- Straight Time (ST): Monday through Friday from 8:00 AM to 4:30 PM.
- Overtime (OT): All other times Monday through Friday. All day Saturday & Sunday.
- Double Time (DT): All day Holidays.

Step 1. Order Labor

Crane with Operator, Per Hour

Item Code	Description	Discount (\$)	Regular (\$)	Show Site (\$)	X # Crews	X # Hours	= Total
705280	15 Ton, OT Move In	227.12	227.12	227.12			\$
705280	15 Ton, OT Move Out	227.12	227.12	227.12			\$
705280	15 Ton, OT Move In	262.03	262.03	262.03			\$
705280	15 Ton, OT Move Out	262.03	262.03	262.03			\$
705281	20 Ton, ST Move In	232.11	232.11	232.11			\$
705281	20 Ton, ST Move Out	232.11	232.11	232.11			\$
705281	20 Ton, OT Move In	264.04	264.04	264.04			\$
705281	20 Ton, OT Move Out	264.04	264.04	264.04			\$
705282	25 Ton, ST Move In	246.12	246.12	246.12			\$
705282	25 Ton, ST Move Out	246.12	246.12	246.12			\$
705282	25 Ton, OT Move In	280.93	280.93	280.93			\$
705282	25 Ton, OT Move Out	280.93	280.93	280.93			\$
705283	30 Ton, ST Move In	290.56	290.56	290.56			\$
705283	30 Ton, ST Move Out	290.56	290.56	290.56			\$
705283	30 Ton, OT Move In	325.43	325.43	325.43			\$
705283	30 Ton, OT Move Out	325.43	325.43	325.43			\$
705284	35 Ton, ST Move In	335.01	335.01	335.01			\$
705284	35 Ton, ST Move Out	335.01	335.01	335.01			\$
705284	35 Ton, OT Move In	369.87	369.87	369.87			\$
705284	35 Ton, OT Move Out	369.87	369.87	369.87			\$
705296	50 Ton, ST Move In	342.45	342.45	342.45			\$
705296	50 Ton, ST Move Out	342.45	342.45	342.45			\$
705296	50 Ton, OT Move In	377.24	377.24	377.24			\$
705296	50 Ton, OT Move Out	377.24	377.24	377.24			\$

T-2 031517 Cstm 040417 051600379

Crane/Versa Lift/Rigging Labor Order Form

All orders are governed by the GES Payment Policy and GES Terms & Conditions of Contract as specified in this Exhibitor Services Manual.

Company Name _____ Email _____ Phone Number _____ Booth Number _____

Forklift with Operator, Per Hour

Item Code	Description	Discount (\$)	Regular (\$)	Show Site (\$)	X # Crews	X # Hours	= Total
705200	5,000#, ST Move In	147.00	147.00	147.00			\$
705200	5,000#, ST Move Out	147.00	147.00	147.00			\$
705200	5,000#, OT Move In	220.50	220.50	220.50			\$
705200	5,000#, OT Move Out	220.50	220.50	220.50			\$
705202	10,000#, ST Move In	163.00	163.00	163.00			\$
705202	10,000#, ST Move Out	163.00	163.00	163.00			\$
705202	10,000#, OT Move In	244.50	244.50	244.50			\$
705202	10,000#, OT Move Out	244.50	244.50	244.50			\$
705204	15,000#, ST Move In	187.00	187.00	187.00			\$
705204	15,000#, ST Move Out	187.00	187.00	187.00			\$
705204	15,000#, OT Move In	280.50	280.50	280.50			\$
705204	15,000#, OT Move Out	280.50	280.50	280.50			\$

Versa Lift with Operator, Per Hour

Item Code	Description	Discount (\$)	Regular (\$)	Show Site (\$)	X # Crews	X # Hours	= Total
705270	Versalift, 35,000#, ST Move In	229.00	229.00	229.00			\$
705270	Versalift, 35,000#, ST Move Out	229.00	229.00	229.00			\$
705270	Versalift, 35,000#, OT Move In	343.50	343.50	343.50			\$
705270	Versalift, 35,000#, OT Move Out	343.50	343.50	343.50			\$

Hate math? Let Espresso calculate your rates: <https://e.ges.com/051600379/labor/esm>

Step 2. Labor Information



What is Exhibitor Supervision? An exhibitor chooses Exhibitor Supervised so they are able to instruct the laborer. The exhibitor is required to be in the booth and there are no supervision fees. Scheduling a date and time is necessary for this choice.

Exhibitor Supervised (Do Not Proceed)

Exhibitor will supervise.

- Indicate workers needed for installation and dismantling
- GES assumes no liability for loss, damage or bodily injury arising out of the installation and/or dismantling of Exhibitor's property by GES provided union labor. Exhibitor assumes the responsibility and any liability arising therefrom, for the work performed by union labor under Exhibitor's supervision. Exhibitors must stay clear during movement of freight.

GES is responsible for the following type(s) of work:

- Uncrating
- Unskidding
- Positioning
- Leveling
- Dismantling
- Re-crating
- Reskidding

Additional labor will be assigned if necessary.

T-2 031517 Cstm 040417 051600379



All orders are governed by the GES Payment Policy and GES Terms & Conditions of Contract as specified in this Exhibitor Services Manual.

Company Name _____ Email _____ Phone Number _____ Booth Number _____

Step 3. Schedule Equipment/Labor

Labor and Crews requested for the start of the working day at 8:00 AM. All exhibit labor for 8 AM starting times will be dispatched to booth space. Confirm labor and forklifts by 2:30 PM the day before date requested. Please have a representative pick up the crew at the labor desk and supervise the work to be done. Upon completion, the Exhibitor's representative will return the crew to the labor desk and approve the work order. Equipment and labor cancelled without a 24 hour notice shall be charged a one (1) hour cancellation fee per worker and forklift. If Exhibitor fails to use the workers and equipment at the time confirmed, a one (1) hour "No-Show" charge per worker and forklift will apply.

The minimum charge for labor is one (1) hour per worker and equipment. Labor thereafter is charged in half (1/2) hour increments per worker and equipment. Gratuities in any form, including cash, gifts, or labor hours for work not actually performed are prohibited by GES. GES requires the highest standards of integrity from all employees. Please call our confidential Always Honest hotline at 866.225.8230 to report fraudulent or unethical behavior. All rates are subject to change if necessitated by increased labor and material costs.

Please estimate the number of workers and hours per worker needed for installation. Invoice will be calculated according to actual hours worked, relative to the original estimate and based upon the date received. Additional labor required will be calculated and invoiced at the show site rate.

Move In

Schedule Dates	Schedule Start Time	Schedule End Time	Type of Equipment
MM/DD/YR	AM PM	AM PM	
MM/DD/YR	AM PM	AM PM	
MM/DD/YR	AM PM	AM PM	
MM/DD/YR	AM PM	AM PM	

Schedule Dates	Schedule Start Time	Schedule End Time	Type of Equipment
MM/DD/YR	AM PM	AM PM	
MM/DD/YR	AM PM	AM PM	
MM/DD/YR	AM PM	AM PM	
MM/DD/YR	AM PM	AM PM	

Move Out

Schedule Dates	Schedule Start Time	Schedule End Time	Type of Equipment
MM/DD/YR	AM PM	AM PM	
MM/DD/YR	AM PM	AM PM	
MM/DD/YR	AM PM	AM PM	
MM/DD/YR	AM PM	AM PM	

Schedule Dates	Schedule Start Time	Schedule End Time	Type of Equipment
MM/DD/YR	AM PM	AM PM	
MM/DD/YR	AM PM	AM PM	
MM/DD/YR	AM PM	AM PM	
MM/DD/YR	AM PM	AM PM	

Total and Sign: Return to Fax: 866.329.1437 • International Fax: 702.263.1520

Please Sign _____
 Authorized Signature

_____ Date
 Authorized Name - Please Print

I agree in placing this order that I have accepted GES Payment Policy and GES Terms & Conditions of Contract, including authorization for GES to retain personal information to better serve my need for GES services at future events.

Total Payment Enclosed \$ _____

T-2 031517 Cstm 040417 051600379

Hanging Sign / Truss Labor Information

All orders are governed by the GES Payment Policy and GES Terms & Conditions of Contract as specified in this Exhibitor Services Manual.

Forest Products Machinery & Equipment Exposition
Georgia World Congress Center
June 14 - 16, 2017

Please complete and return the Hanging Sign / Truss Labor Order Form by May 22, 2017.

By sending us this information in advance you will help us assure your sign is properly assembled and installed.



Hanging Signs:

GES is responsible for assembly, installation, and removal of all hanging signs

- All signs must be designed to comply with Show Organizer rules and regulations and facility limitations.
- Make sure all signs, with the exception of cloth banners and signs under 100 lbs., have structurally engineered rigging points as well as blueprints displaying a current structural engineer's stamp.
- If your sign requires electricity, make sure it is in working order and in accordance with the National Electric Code.
- Include Showsite Exhibitor contact information with the order.
- Include engineer-stamped drawings with hanging instructions as well as a set of assembly instructions (placement/orientation) with the order. GES accepts no liability for any work completed without such instructions, when required. Work is done at Exhibitor's risk and Exhibitor shall indemnify and defend GES and Show Organizer from any claims arising out of or related to the installation or dismantle of any sign without approved drawings.



Truss and Hoists:

GES is responsible for assembly, installation, and removal of all truss.

- All truss must be designed to comply with Show Organizer rules and regulations as well as facility limitations.
- All truss must be from a recognized manufacturer. Manufacturer load specifications for your truss must be at show site prior to rigging.
- Climbing on truss is strictly prohibited.
- All lamps and fixtures to be attached to truss must be in good working order and in compliance with the National Electric Code.
- All hoists must be from a recognized manufacturer and must be in good working order.
- Hoist maintenance records should be available for inspection by GES.

Hanging Sign / Truss Labor Order Form

All orders are governed by the GES Payment Policy and GES Terms & Conditions of Contract as specified in this Exhibitor Services Manual.

Forest Products Machinery & Equipment Exposition
 Georgia World Congress Center
 June 14 - 16, 2017

Discount Deadline Date:
 May 22, 2017

Company Name	Email	Phone Number	Booth Number
Show Site Contact	Show Site Email	Show Site Phone Number	



Easy Ordering Tips:

- A crew will be assigned consisting of a lift with two riggers for aerial work.
- Don't forget to order labor for Move In and Move Out.
- Straight Time (ST): Monday through Friday from 8:00 AM to 4:30 PM.
- Overtime (OT): All other times Monday through Friday. All day Saturday & Sunday.
- Double Time (DT): All day Holidays.

Step 1. Order Labor

Lift with Operator, Per Hour

Item Code	Description	Discount (\$)	Regular (\$)	Show Site (\$)	# Crews	# Hours	Total
705300	High Lift, ST Move In	560.00	700.00	840.00			\$
705300	High Lift, ST Move Out	560.00	700.00	840.00			\$
705300	High Lift, OT Move In	700.00	875.00	1,050.00			\$
705300	High Lift, OT Move Out	700.00	875.00	1,050.00			\$

Sign Assembly (Non-Electrical)

Item Code	Description	Discount (\$)	Regular (\$)	Show Site (\$)	X # Workers	X # Hours	= Total
705020	Sign Assembly, ST Move In Only	72.00	72.00	72.00			\$
705020	Sign Assembly, OT Move In Only	108.00	108.00	108.00			\$

Hate math? Let Espresso calculate your rates: <https://e.ges.com/051600379/labor/esm>



What is Exhibitor Supervision? An exhibitor chooses Exhibitor Supervised so they are able to instruct the laborer. The exhibitor is required to be in the booth and there are no supervision fees. Scheduling a date and time is necessary for this choice.

What is GES Supervision? An exhibitor chooses GES Supervised when they do not want to be present when the work is completed. On most shows and services, there is a minimum surcharge for the professional supervision. Remember, when an exhibitor chooses this option, they do not need to schedule a date and time for services to be completed.

H-2 031017 040417 051600379

All orders are governed by the GES Payment Policy and GES Terms & Conditions of Contract as specified in this Exhibitor Services Manual.

Discount Deadline Date:
May 22, 2017

Company Name _____ Email _____ Phone Number _____ Booth Number _____

Show Site Contact _____ Show Site Email _____ Show Site Phone Number _____

Step 2. Please Indicate Service Hanging Sign Options

How many signs will be hung in your booth?

(if there are multiple signs, please complete an order form for each sign and label 1 of 3, etc)

Type of Sign

- Banner Structural Signage
 Systems Moss

Dimensions and Weight of Sign

Width _____ Height _____
Length _____ Total Weight _____ lbs

Height

Number of feet from floor to top of sign:
_____ Feet

Must be compliant with Show Rules and Regulations.

Electrical

(Not provided by GES. These services must be ordered through the electrical service provider)

Is your sign electrical?

- Yes No

Shape of Sign

- Square Rectangle
 Triangle Circle
 Serpentine Other _____

Pick Points

Number of structural pick points _____

Weight at each pick point _____

Have you submitted your structurally engineered rigging points? _____

Dates Submitted _____

Assembly

Does your sign require assembly?

- Yes No

If yes, GES must assemble your sign prior to hanging. See Hanging Sign / Truss Labor Rate and Information.

Hoists

(Not provided by GES. These services must be ordered through the facility)

Are hoists required?

- Yes No

if yes, how many? _____

- Exhibitor Owned GES Rental

Supervision

Do you want to supervise the hanging of your sign?

- Yes No

If yes, schedule the date you would like the sign to be hung in Step 3 of this form.

Please provide GES with a contact name and number to discuss _____

If no, GES will supervise without exhibitor present.

- A 25% (\$50.00 minimum) surcharge will be added to the labor rates above for this professional supervision.
- Date and time not required. No need to complete Step 3. Proceed to Total and Sign.

If your Hanging Sign is received in the advance warehouse, and GES has all the required information, your Hanging Sign could possibly be hung prior to your arrival.

Location of Sign

Use the Booth Layout Form provided in the kit to represent your booth and indicate placement of your sign. Sign Orientation must be given by providing surrounding booth numbers.

040417 051600379

H-2 031017

All orders are governed by the GES Payment Policy and GES Terms & Conditions of Contract as specified in this Exhibitor Services Manual.

Discount Deadline Date:
May 22, 2017

Company Name _____ Email _____ Phone Number _____ Booth Number _____

Show Site Contact _____ Show Site Email _____ Show Site Phone Number _____

Truss Options

Type of Truss

- Plated (end plates) Spigot

Size of Truss

- 12" 20.5"

Dimensions Truss Design

Width _____ Length _____
Total Truss/Lighting Weight _____ lbs

Height

Number of feet from floor to top of sign:
_____ Feet
Must be compliant with Show Rules and Regulations.

Electrical

Do you require an electrical drop to the truss?

- Yes No

How much power is required for the truss?

Please provide a diagram for electrical drop and placement with your order.

GES will automatically apply your power and labor to install the drop on your account. See Electrical Outlet and Labor Order Forms for rates.

Truss Attachments

- Audio Visual Equipment*
- Signage/Banners
- Static Lighting
- Dimmable/Programmable Lighting*

*Stagehand labor is required. Please refer to the Stagehand Labor Order Form.

Pick Points

Number of structural pick points _____

The weight, point loads and the load path to the ceiling should be prepared on a .dwg format and reflected on a scaled (Imperial Units) truss/lighting plot plan, submitted along with this order form. A Reflective Ceiling Plot (RCP) may be requested electronically from the installing city to assist you in completing your drawing. GES is able to provide assistance at creating the .dwg for your truss rig at an additional cost. Please see example attached.

Assembly

GES is required to assemble your flown truss prior to installation. See Step 1 of this form for rates.

Location of Truss

- Aerial/Flown Ground Supported

Use the Booth Layout Form provided in the kit to represent your booth and indicate truss location from booth boundaries the placement of your sign. Truss Orientation must be given by providing surrounding booth numbers.

Hoists

Are hoists required?

- Yes No

if yes, how many? _____

- Exhibitor Owned GES Rental

Exhibitor owned hoists must be certified. If asked upon on show floor for records, exhibitor must provide within 1 hour of request.

Please note that GES will automatically apply a motor outlet for every hoist placed in the booth on your account.

For installations that are deemed considerably heavy, out of the ordinary or unusual, a structural engineer stamp may be required at GES discretion. Work is done at exhibitor's risk and exhibitor shall indemnify and defend GES and the show organizer from any claims and/or bodily injuries arising out of or related to the installation of any truss without engineered stamped drawings.

040417 051600379

H-2 031017

Hanging Sign / Truss Labor Order Form

All orders are governed by the GES Payment Policy and GES Terms & Conditions of Contract as specified in this Exhibitor Services Manual.

Discount Deadline Date:
May 22, 2017

Company Name _____ Email _____ Phone Number _____ Booth Number _____

Show Site Contact _____ Show Site Email _____ Show Site Phone Number _____

Step 3. Schedule Hanging Sign Labor for Exhibitor Supervised Work

Starting time can be guaranteed only when labor is requested for the start of the working day. All exhibit labor scheduled at the start of the working day will be dispatched to booth space. Confirm labor and equipment by 2:30 PM the day before date requested. If labor is not requested for the start of the working day, please have a representative pick up the crew at the labor desk and supervise the work to be done. Upon completion, the Exhibitor's representative will return the crew to the labor desk and approve the work order. Equipment and labor cancelled without a 24 hour notice shall be charged a one (1) hour cancellation fee per worker and equipment. If Exhibitor fails to use the workers and equipment at the time confirmed, a one (1) hour "Not Ready" charge per worker and equipment will apply.

The minimum charge for labor is one (1) hour per worker and equipment. Labor thereafter is charged in half (½) hour increments per worker and equipment. Gratuities in any form, including cash, gifts, or labor hours for work not actually performed are prohibited by GES. GES requires the highest standards of integrity from all employees. Please call our confidential Always Honest hotline at 866.225.8230 to report fraudulent or unethical behavior. All rates are subject to change if necessitated by increased labor and material costs.

Please estimate the number of workers and hours per worker needed for installation. Invoice will be calculated according to actual hours worked, relative to the original estimate and based upon the date received. Additional labor required will be calculated and invoiced at the show site rate.

Move In

Schedule Dates	Schedule Start Time	Schedule End Time	Number of Lifts/Workers
MM/DD/YR	AM PM	AM PM	
MM/DD/YR	AM PM	AM PM	

Schedule Dates	Schedule Start Time	Schedule End Time	Number of Lifts/Workers
MM/DD/YR	AM PM	AM PM	
MM/DD/YR	AM PM	AM PM	

Move Out

Schedule Dates	Schedule Start Time	Schedule End Time	Number of Lifts/Workers
MM/DD/YR	AM PM	AM PM	
MM/DD/YR	AM PM	AM PM	

Schedule Dates	Schedule Start Time	Schedule End Time	Number of Lifts/Workers
MM/DD/YR	AM PM	AM PM	
MM/DD/YR	AM PM	AM PM	

Total and Sign: Return to Fax: 866.329.1437 • International Fax: 702.263.1520

Please Sign

X _____
Authorized Signature

Authorized Name - Please Print Date

I agree in placing this order that I have accepted GES Payment Policy and GES Terms & Conditions of Contract, including authorization for GES to retain personal information to better serve my need for GES services at future events.

Total Payment Enclosed \$ _____

H-2 031017 040417 051600379

Use these shipping labels as they will expedite handling. Copies of these labels are acceptable if additional labels are needed.



FROM:



FROM:

Please print this label on a color printer if possible



TO:

Full Exhibiting Company Name at Show

Forest Products Machinery & Equipment Exposition

Name of Exhibition 0510600379

Booth Number

C/O GES
RAC Logistic LLC
4351 Thurman Road
Conley, GA 30288 USA

Shipment Should Arrive on or Between:
Tuesday, May 9, 2017 - Wednesday, June 7, 2017

Certified Weight Tickets are required for all Shipments. Drivers must check in by 2:00 PM to be guaranteed same day unloading. Warehouse receiving hours are Monday - Friday, 8:00 AM - 4:30 PM; Closed 12:00 PM - 1:00 PM & Holidays.

Carrier _____ of _____ pieces GES Global Experience Specialists



TO:

Full Exhibiting Company Name at Show

Forest Products Machinery & Equipment Exposition

Name of Exhibition 0510600379

Booth Number

C/O GES
RAC Logistic LLC
4351 Thurman Road
Conley, GA 30288 USA

Shipment Should Arrive on or Between:
Tuesday, May 9, 2017 - Wednesday, June 7, 2017

Certified Weight Tickets are required for all Shipments. Drivers must check in by 2:00 PM to be guaranteed same day unloading. Warehouse receiving hours are Monday - Friday, 8:00 AM - 4:30 PM; Closed 12:00 PM - 1:00 PM & Holidays.

Carrier _____ of _____ pieces GES Global Experience Specialists

Please print this label on a color printer if possible

Cleaning and Porter Service Order Form

All orders are governed by the GES Payment Policy and GES Terms & Conditions of Contract as specified in this Exhibitor Services Manual.

Forest Products Machinery & Equipment Exposition
 Georgia World Congress Center
 June 14 - 16, 2017

Discount Deadline Date:
 May 22, 2017

Company Name _____ Email _____ Phone Number _____ Booth Number _____



Easy Ordering Tips:

- Vacuuming includes emptying your wastebasket nightly.
- If ordering Porter Service, GES will empty wastebaskets and wipe down counters at two hour intervals during show hours only. (Vacuuming is not included. Calculate by your booth size.)
- Cost of services will be invoiced based on the total area of your booth.

Step 1. Calculate Booth Square Footage

Width 10 X Length 10 = 100 Total Sq. Ft.

Step 2. Order Cleaning Services

Vacuuuming

Item Code	Description	Discount (\$)	Regular (\$)	Sq. Ft.	# of Days / Qty	Total
500601	Before Show Open Only (per sq. ft.)	0.74	1.03		1	\$
500600	Duration of Show (per sq. ft. per day)	0.53	0.74		3	\$
500602	Per Day (per sq. ft. per day)	0.73	1.02			\$

Shampooing

Item Code	Description	Discount (\$)	Regular (\$)	Sq. Ft.	Total
501004	Cleaning, Carpet Shampoo Before Show Open	0.87	1.21		\$

Mopping and Waxing

Item Code	Description	Discount (\$)	Regular (\$)	Sq. Ft.	# of Days / Qty	Total
501002	Cleaning, Damp Mop & Wax	1.15	1.60			\$

Porter Service - Emptying Wastebaskets

Item Code	Description	Discount (\$)	Regular (\$)	Sq. Ft.	# of Days / Qty	Total
501010	Porter Service, 0-500 sq.ft., Per Day	154.00	214.00			\$
501010	Porter Service, 501-1500 sq.ft., Per Day	191.00	265.00			\$
501010	Porter Service, 1501-3000 sq.ft., Per Day	231.00	321.00			\$
501010	Porter Service, 3001 sq.ft. & Up, Per Day	270.00	375.00			\$

Step 3. List dates and times Vacuuming Per Day/Periodic Porter service is needed:

Schedule Dates	Schedule Start Time	Schedule End Time	Schedule Dates	Schedule Start Time	Schedule End Time	Schedule Dates	Schedule Start Time	Schedule End Time
MM/DD/YR	AM PM	AM PM	MM/DD/YR	AM PM	AM PM	MM/DD/YR	AM PM	AM PM
MM/DD/YR	AM PM	AM PM	MM/DD/YR	AM PM	AM PM	MM/DD/YR	AM PM	AM PM

Total and Sign: Return to Fax: 866.329.1437 • International Fax: 702.263.1520

Please Sign _____
 Authorized Signature

_____ Date
 Authorized Name - Please Print

I agree in placing this order that I have accepted GES Payment Policy and GES Terms & Conditions of Contract, including authorization for GES to retain personal information to better serve my need for GES services at future events.

Total Payment Enclosed

Cancellation Policy: Due to material and labor costs, orders cancelled before move-in begins will be charged **50%** of original price. Similarly, orders cancelled after move-in will be charged **100%**.

051600379
040417
J-1 013017

Notice of Intent to Use EAC and Policies and Procedures

All orders are governed by the GES Payment Policy and GES Terms & Conditions of Contract as specified in this Exhibitor Services Manual.

Forest Products Machinery & Equipment Exposition
Georgia World Congress Center
June 14 - 16, 2017

Form Deadline Date:
May 12, 2017

Company Name _____ Email _____ Phone Number _____ Booth Number _____



Attention:

- This form is to be completed by the Exhibitor

An Exhibitor Appointed Contractor (EAC) is a company other than the "general or official" service provider on the show that requires access to your booth during installation and dismantling. The EAC may only provide services in the facility that are not designated by the facility as "exclusive" to a designated provider, or by the show organizer in a contract as an exclusive service for the "general or official" service provider or other third party.

No EAC will be allowed to work in an exhibitor's booth if this Notice of Intent to Use EAC and Policies and Procedures form, a valid Certificate of Insurance and the Agreement, and Rules and Regulations between GES and the EAC form is not completed by an authorized representative and received by GES by the deadline indicated above. This Notice of Intent to Use EAC and Policies and Procedures form must be completed for every third party (as well as any other third party ordering or requesting services from GES on behalf of exhibitor) at the above show. Multiple booths are not to be listed on one form.

Exhibitor Appointed Contractor: _____

Contact Name: _____ Cell Phone: _____

Street Address: _____ Email: _____

City: _____ State: _____ Zip/Postal Code: _____

Office Phone: (area code) _____ Fax: (area code) _____

Description of proposed service for Exhibitor: _____

This form will only be accepted if it is executed by an authorized representative of the exhibiting company, and must include:

- An executed Agreement and Rules and Regulations between GES and EAC.
- A valid certificate of insurance prepared by the EAC's insurance agent with the minimum coverages as set forth in the Agreement and Rules and Regulations between GES and EAC.



X

Authorized Cardholder's Signature

Authorized Cardholder's Name - Please Print Date

Review and Return [Return to Fax: 866.329.1437](tel:866.329.1437) • [International Fax: 702.263.1520](tel:702.263.1520)

GES shall have no liability to any party for damage or injuries caused by exhibitor or its third party agents. It is the exhibitor's responsibility to provide its EACs with all show rules and regulations as set forth in the exhibitor space lease and the Exhibitor Services Manual. Exhibitor agrees to indemnify and defend GES for the actions of its agents and exhibitor appointed contractors. The exhibitor agrees that it is ultimately responsible for all services in connection with the exhibit, including freight, rentals and labor. Exhibitor agrees to be responsible for any losses, damages or injuries that are caused by or attributed to EACs that are not covered or provided by EAC's insurance.

040417 051600379

L-3/L-4 101216



Agreement and Rules and Regulations between GES and EAC

All orders are governed by the GES Payment Policy and GES Terms & Conditions of Contract as specified in this Exhibitor Services Manual.

Forest Products Machinery & Equipment Exposition
Georgia World Congress Center
June 14 - 16, 2017

Form Deadline Date:
May 12, 2017

Company Name	Email	Phone Number	Booth Number
--------------	-------	--------------	--------------



Attention:

- This form is to be completed by the EAC

The undersigned Exhibitor Appointed Contractor (EAC) has been designated by an exhibitor to perform certain services for the exhibitor at the above referenced show. In consideration of the show organizer and GES permitting the EAC to perform such services at the show, the EAC and GES hereby agree as follows:

Rules and Regulations

- EAC agrees to comply with all rules and regulations of the show as outlined in this agreement, the Exhibitor Services Manual, including all union rules and regulations, and accept liability for any negligent actions.
- EAC agrees that it must ascertain and comply with all rules and regulations of the venue, Show Management, and/or the Official Service Provider in order to create a safe work environment. A failure to do so can result in a delay or termination of your right to continue work if the condition cannot be corrected.
- EAC agrees that the show site, dock and surrounding areas are active work zones and the EAC, its agents, employees and representatives are present at their own risk. Entry into the dock area is prohibited.
- EAC must have all business licenses and permits required by the State and City governments and the convention facility management prior to commencing work. A certificate of insurance naming GES as an additional insured with appropriate insurance limits prepared by the EAC's insurance agent must be submitted to GES at least 30 days prior to the first date of move-in.
- This Agreement and Rules and Regulations between GES and EAC must be completed by an authorized representative of EAC and returned to GES before the deadline noted above.
- If the EAC fails to provide the documentation required in paragraphs 4 and 5 above, the exhibitor will be required to use GES for such services at the prevailing rates set forth in the Exhibitor Services Manual.
- EAC shall provide, if requested, evidence to Global Experience Specialists, Inc. (GES) that it possesses applicable and current labor contracts and must comply with all labor agreements and practices. The EAC must not commit or allow to be committed by persons in its employment any acts that could lead to work stoppages, strikes or labor problems.
- EAC will be responsible for all reasonable costs related to its operation, including overtime pay for stewards, restoration of exhibit space to its initial condition, etc. Where applicable a one hour minimum labor charge will be charged at the appropriate steward rate of pay per day/per union to either the EAC/exhibitor depending upon the billing arrangement set up with GES (based upon EAC not number of booths).
- The show aisles and public spaces are not part of the exhibitor's booth. Therefore, EAC is required to confine all activities to the exhibit space of the exhibitor who has given a valid order for services. Exhibitors may be charged for costs related to movement of its property if the EAC does not contain its operations within the confines of the booth. No service desks, storage areas or other work facilities will be located anywhere in the building. The show aisles and public space are not a part of the exhibitor's booth space and must be kept clear at all times.
- During show hours, only EACs with exhibit badges will be permitted on the exhibit floor. No EAC will be permitted on the exhibit floor during show hours without the proper Convention name badge supplied by the exhibiting company. EAC must furnish Show Management and GES with the names of all on-site employees who will be working on the show floor and ensure that they have and wear identification badges at all times necessary as determined by Show Management.
- EAC has attached herewith certificates of insurance confirming the following required insurance:
 - Commercial General Liability, including contractual liability, with limits of not less than \$1,000,000 each occurrence, \$2,000,000 general aggregate and \$2,000,000 products & completed operations aggregate.
 - Automobile Liability with a limit of not less than \$1,000,000 combined single limit - each accident.
 - Workers Compensation, as required by law, with Employers Liability Limits of not less than \$1,000,000 each accident, \$1,000,000 disease - each employee and \$1,000,000 disease - policy limit.
 - Umbrella/Excess Liability with a limit of not less than \$1,000,000 each occurrence/aggregate.
 - All Policies (except Worker's Compensation) shall name Global Experience Specialists, Inc. (GES) (Official Service Provider), Forest Products Machinery & Equipment Exposition (Show Management), Forest Products Machinery & Equipment Exposition (Show) and Georgia World Congress Center (Facility) as additional insureds on a primary and non-contributory basis per the attached sample certificate of insurance.
- EAC agrees to indemnify, defend and hold the Show Management, the Facility and Global Experience Specialists, Inc. (GES) harmless from and against any and all claims, lawsuits, demands, liability, costs and expenses, including reasonable attorney's fees and court costs, arising out of EAC's operations, including supervision of GES provided labor. EAC also agrees to reimburse GES for all attorney's fees and costs incurred in connection with any and all claims, lawsuits and counterclaims that should arise out of EAC's failure to adhere to the terms of this agreement.
- Solicitation of business on the show floor is strictly prohibited. If EAC attempts to provide services designated to another party as "exclusive" or is discovered soliciting on the show floor including the distribution of official company literature, or otherwise does not comply with the rules, the company may be removed from the show floor, and the exhibitor will not be able to use that company for the remainder of the event.
- EAC/ exhibitor may not move freight from one booth to another booth, or to meeting rooms. GES must provide labor.
- EAC must coordinate all of its activities with Global Experience Specialists, Inc. (GES).
- The exhibitor or its EAC should order services required from GES and the Exhibit Hall in advance. Ordering labor or services onsite (which contractors may not be prepared to provide immediately) may delay the set-up of your booth or force your set-up into overtime.

L-3/L-4 101216 040417 051600379

Agreement and Rules and Regulations between GES and EAC

All orders are governed by the GES Payment Policy and GES Terms & Conditions of Contract as specified in this Exhibitor Services Manual.

Forest Products Machinery & Equipment Exposition
 Georgia World Congress Center
 June 14 - 16, 2017

Form Deadline Date:
 May 12, 2017

Company Name	Email	Phone Number	Booth Number
--------------	-------	--------------	--------------

Rules and Regulations (continued)

17. The exhibitor or its EAC should take steps to protect the exhibitor and the EAC's product in the booth by arranging for booth security and/or cages. GES is not responsible for items left unattended on the show floor.
18. EAC agrees GES is not responsible for any items stored in empty containers. Do not store empty cartons inside of empty crates. Cartons are returned from storage before crates so exhibitors may begin packing their product.
19. EAC/exhibitor agrees to keep "No Freight Aisles" clear at all times. If GES is required to rearrange any material situated in a clearly identified "No Freight Aisle," the exhibitor or the EAC depending upon the billing arrangements with GES will be charged a one hour minimum for forklift rental and labor.
20. EAC/exhibitor agrees that all outbound freight bills should be turned into the service desk on a timely basis. Holding freight bills until late in the day or turning in large amounts of freight bills to the GES Servicercenter at one time may delay outbound truck scheduling and subsequently force your loading out into overtime.
21. During tear down, pull all manageable structures back from aisle carpet lines. Electronics, mannequins, etc. should be placed in the center of the booth.
22. Be aware of vehicle traffic inside and outside of the facility. All attendees should be aware of their surroundings and all individuals are solely responsible for their own safety in parking lots, driveways, access roads and non-exhibit hall areas.
23. Label empty cartons and crates for storage as soon as they are ready. Holding back on "empties" only adds congestion to the aisles.
24. For services such as electrical, plumbing, telephone, cleaning and drayage, no service provider other than the Official Service Provider will be approved. This regulation is necessary due to licensing, insurance and work done on equipment and facilities owned by parties other than the exhibitor. Exhibitors shall provide only the material and equipment they own and those materials are to be used only in their exhibit space.
25. Smoking is prohibited in most facilities. Smoking shall only be allowed in designated areas.
26. This agreement is to be interpreted under the laws of the State of Nevada.
27. A faxed signature will serve as an original signature and will stand as a fully executed agreement once faxed to and received by GES.

Authorized Signature of EAC:

Please Sign _____
 Authorized Cardholder's Signature

_____ Date
 Authorized Cardholder's Name - Please Print

Review and Return Return with Certificate of Insurance to: Global Experience Specialists, Inc. (GES), Exhibitor Services, 750 Maxham Road, Suite 300, Lithia Springs, GA 30122

Printed Name: _____
 Title: _____
 Company: _____
 Address: _____ City: _____ State: _____ Zip/Postal Code: _____
 Contact Name at Show Site: _____
 Office Phone: _____ Cell Phone at Show Site: _____

Official Use Only	
Accepted by GES Authorized Representative:	
X	
Authorized Signature	
Authorized Name - Please Print	Date

L-3/L-4 101216 040417 051600379

ACORD 1. **CERTIFICATE OF LIABILITY INSURANCE** DATE (MM/DD/YY)
01/01/17

PRODUCER ABC Insurance Agency Fax: (212) 555-6100 1234 Broker Lane New York, NY 10895 Attn: Joe Agent (212) 555-6102 ext. 1234	THIS CERTIFICATE IS ISSUED AS A MATTER OF INFORMATION ONLY AND CONFERS NO RIGHTS UPON THE CERTIFICATE HOLDER, THIS CERTIFICATE DOES NOT AMEND, EXTEND OR ALTER THE COVERAGE AFFORDED BY THE POLICIES BELOW. INSUREERS AFFORDING COVERAGE
---	---

INSURED 2. Big Boom Company, Inc. 1234 Corporate Lane New York, NY 10895 Attn: Joe Smith Phone: (212) 555-5349 Fax: (212) 555-9819	INSURER A: Hartford Insurance Company of Illinois INSURER B: Aetna Casualty & Surety Company INSURER C: Travelers Insurance Company INSURER D: Royal Insurance Company INSURER E:
---	---

3. THE POLICIES OF INSURANCE LISTED BELOW HAVE BEEN ISSUED TO THE INSURED NAMED ABOVE FOR THE POLICY PERIOD INDICATED, NOTWITHSTANDING ANY REQUIREMENT, TERM OF CONDITION OF ANY CONTRACT OR OTHER DOCUMENT WITH RESPECT TO WHICH THIS CERTIFICATE MAY BE ISSUED OR MAY PERTAIN, THE INSURANCE AFFORDED BY THE POLICIES DESCRIBED HEREIN IS SUBJECT TO ALL THE TERMS, EXCLUSIONS AND CONDITIONS OF SUCH POLICIES. LIMITS SHOWN MAY HAVE BEEN REDUCED BY PAID CLAIMS.

INSR LTR	4. TYPE OF INSURANCE	POLICY NUMBER	7. POLICY EFFECTIVE DATE (MM/DD/YY)	8. POLICY EXPIRATION DATE (MM/DD/YY)	9. LIMITS
A	GENERAL LIABILITY <input checked="" type="checkbox"/> COMMERCIAL GENERAL LIABILITY <input type="checkbox"/> CLAIMS MADE <input checked="" type="checkbox"/> OCCUR <input type="checkbox"/> _____ <input type="checkbox"/> _____ GENERAL AGGREGATE LIMIT APPLIES PER <input type="checkbox"/> POLICY <input type="checkbox"/> PROJECT <input type="checkbox"/> LOC	000P98298-A11	01/01/17	01/01/18	EACH OCCURRENCE \$1,000,000
	FIRE DAMAGE (Any one fire) \$ 50,000				
	MED EXP (Any one person) \$ 5,000				
	PERSONAL & ADV INJURY \$1,000,000				
	GENERAL AGGRREGATE \$2,000,000				
	PRODUCTS-COMP/OP AGG \$2,000,000				
B	AUTOMOBILE LIABILITY <input checked="" type="checkbox"/> ANY AUTO <input type="checkbox"/> ALL OWNED AUTOS <input type="checkbox"/> SCHEDULED AUTOS <input type="checkbox"/> HIRED AUTOS <input checked="" type="checkbox"/> NON-OWNED AUTOS <input type="checkbox"/> _____ <input type="checkbox"/> _____	SKLS-029499S	01/01/17	01/01/18	COMBINED SINGLE LIMIT \$1,000,000 (Ea accident)
	BODILY INJURY \$ (Per person)				
	BODILY INJURY \$ (Per accident)				
	PROPERTY DAMAGE \$ (Per accident)				
	AUTO ONLY-EA ACCIDENT				
	OTHER THAN AUTO ONLY: \$ \$				
A	UMBRELLA/EXCESS LIABILITY <input checked="" type="checkbox"/> OCCUR <input type="checkbox"/> CLAIMS MADE <input type="checkbox"/> DEDUCTIBLE <input type="checkbox"/> RETENTION \$	XL1234567	01/01/17	01/01/18	EACH OCCURRENCE \$1,000,000
	AGGREGATE \$1,000,000				
	_____ \$				
	_____ \$				
	_____ \$				
C	WORKERS COMPENSATION AND EMPLOYERS' LIABILITY	A4145-SS-PJ37	01/01/17	01/01/18	X WC STATU-ORY LIMITS OTHER
	E.L. EACH ACCIDENT \$1,000,000				
	E.L. DISEASE-EA EMPLOYEE \$1,000,000				
	E.L. DISEASE -POLICY LIMIT \$1,000,000				
D	OTHER				Each Occurrence & Aggregate

5. **DESCRIPTION OF OPERATIONS/LOCATIONS/VEHICLES/EXCLUSIONS ADDED BY ENDORSEMENT/SPECIAL PROVISIONS**
 Global Experience Specialists, Inc. (GES) (Official Service Provider), Forest Products Machinery & Equipment Exposition (Show Management), Georgia World Congress Center (Facility), and Forest Products Machinery & Equipment Exposition (Show) are hereby named as additional insured, except for Workers' Compensation. Global Experience Specialists, Inc. (GES) and/or the consignor are included as Loss Payee. The insurance provided for the benefit of Global Experience Specialists, Inc. (GES), shall be primary insurance as respects any claim, loss, or liability, arising out of the Named Insured's operations for which the Named Insured is liable. Any other insurance maintained by GES shall be excess and non-contributory. Show date(s) are: June 14 - 16, 2017 at city of Atlanta.

CERTIFICATE HOLDER X **ADDITIONAL INSURED; INSURER LETTER:** X **CANCELLATION**

6. Global Experience Specialists, Inc. (GES) Exhibitor Services 750 Maxham Road, Suite 300 Lithia Springs, GA 30122	SHOULD ANY OF THE ABOVE DESCRIBED POLICIES BE CANCELLED BEFORE THE EXPIRATION DATE THEREOF, THE ISSUING COMPANY WILL ENDEAVOR TO MAIL 30 DAYS WRITTEN NOTICE TO THE CERTIFICATE HOLDER NAMED TO THE LEFT, BUT FAILURE TO DO SO SHALL IMPOSE NO OBLIGATION OR LIABILITY OF ANY KIND UPON THE INSURER, ITS AGENTS OF REPRESENTATIONS AUTHORIZED REPRESENTATIVE 10.
--	---

1. **Producer:** Insurance Agent / Broker who issues certificate.
2. **Name of Insured:** Must be the legal name of contracting party.
3. **Types of Insurance:** Must include types required by contract. See General Information form in this Exhibitor Services Manual.
4. **Form of Coverage:** Must be "occurrence" form of coverage.
5. **Name of Additional Insureds:** Global Experience Specialists, Inc. (GES) (Official Service Provider), Forest Products Machinery & Equipment Exposition (Show Management), Forest Products Machinery & Equipment Exposition (Show) and Georgia World Congress Center (Facility) as additional insureds on a primary and non-contributory basis.
6. **Certificate Holder:** Must be Global Experience Specialists, Inc. (GES)
7. **Policy Effective Date:** Must be prior to or coincidental with the first day of Exhibitor Move-In.
8. **Policy Expiration Date:** Must be on or after the last day of Exhibitor Move-Out.
9. **Limits of Insurance:** Must be the same or greater than required by contract. See #11 on Agreement and Rules and Regulations between GES and EAC.
10. **Authorized Representative:** Must be signed (not stamped) by an authorized representative of Producer.

L-3/L-4 101216 040417 051600379



Show Site Work Rules

All orders are governed by the GES Payment Policy and GES Terms & Conditions of Contract as specified in this Exhibitor Services Manual.

Forest Products Machinery & Equipment Exposition
Georgia World Congress Center
June 14 - 16, 2017

Union Information

To assist you in planning your participation in your show, we are certain you will appreciate knowing in advance that union labor will be required for certain aspects of your exhibit handling.

Loading and Unloading Display Material and Equipment

The unloading and delivery of all display material and equipment from the convention site docks to the exhibitors' booths and loading out from the exhibitors' booths to trucks at the docks must be performed by the Official Service Contractor who has jurisdiction to deliver such service at the convention site. Please refer to SHIPPING INFORMATION for FURTHER information.

Personally Owned Vehicles (POV's) such as cars, pick up trucks and minivans that are utilized for the unloading/loading of exhibit materials will be monitored by GES Freight Personnel. This will allow exhibitors the opportunity to unload quickly and safely into the exhibit area. All box trucks, straight trucks, personal trucks over one ton, trailers and bobtails or other larger vehicles not classified as a Personally Owned Vehicle, will be directed to the marshalling yard area for GES freight handling services.

Installation and Dismantle

GA is a "right-to-work" state. Exhibitors have the option of utilizing the Official Service Contractor, who provides quality union labor from the Stagehands Union, qualified display houses or personnel from their own companies to install and dismantle displays. Please refer to the EXHIBIT INSTALLATION & DISMANTLING LABOR ORDER FORM for further information. All cleaning is properly the jurisdiction of the Official Service Contractor operating in the building. Display houses or full time employees from the I & D companies, may not clean exhibit booths. All rigging and sign hanging must be performed by the Official Service Contractor.

Gratuities

Our work rules prohibit the solicitation or acceptance of tips in cash, product or gifts in kind by any employee (union or non-union). Our employees are paid appropriate wages denoting professional status, therefore tipping of any kind is not allowed.

Work Zone

Customer acknowledges that the show site and surrounding areas are active work zones. Customer, its agents, employees and representatives are present at their own risk.

Always Honest Hotline

GES requires the highest standards of integrity from all employees. Please call our confidential Always Honest Hotline at (866) 225-8230 to report fraudulent or unethical behavior.

051600379

G-6 022417

Stop. Think. Safety.

All orders are governed by the GES Payment Policy and GES Terms & Conditions of Contract as specified in this Exhibitor Services Manual.

Forest Products Machinery & Equipment Exposition
Georgia World Congress Center
June 14 - 16, 2017



Safety is very important for everyone working in the Exhibit Hall.

GES values safety throughout our organization and demonstrates it in the work we perform. By following the safety guidelines below you will be doing your part in creating a safe work environment.

Safety Guidelines:

- Only authorized personnel and employees allowed, all others are prohibited.
- This is an active work zone.
- All exhibitors and attendees enter at their own risk. Do not enter the dock/yard areas.
- Stay clear of heavy machinery.
- Never stand on furniture.
- Wear closed toe shoes.
- Clean up or report spills.
- Keep aisles free and clear of any and all debris.
- Practice good housekeeping.
- Check electrical cords for damage.
- Protect valuables at show site.
- Report any fires immediately.

If you notice anything unsafe please contact a GES employee immediately.

No individuals under the age of 18 are permitted on the show floor at any time. Show sites during these times are similar to a construction zone and considered to be hazardous. OSHA regulations prohibit minors from being present in a hazardous work environment.

Operation of All Mechanical Lifts

All orders are governed by the GES Payment Policy and GES Terms & Conditions of Contract as specified in this Exhibitor Services Manual.

Forest Products Machinery & Equipment Exposition
Georgia World Congress Center
June 14 - 16, 2017

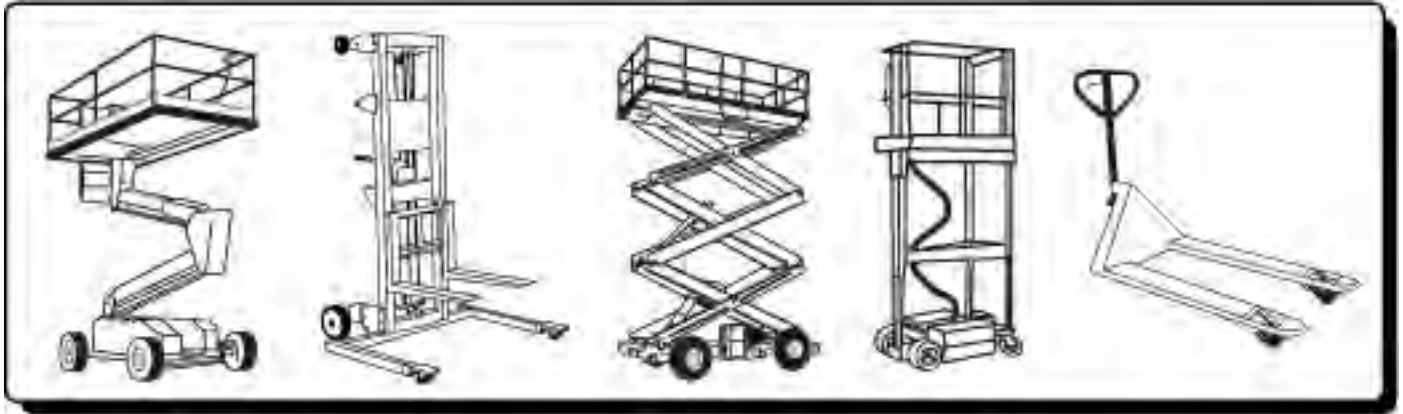

Attention all exhibitors:

- The operation or use of all motorized equipment for installation of booth structures or signs is not permitted by exhibitors or their appointed contractors.
- The operation or use of motorized or mechanical equipment, including mechanical scooters and carts, is not permitted by exhibitors or their appointed contractors for material handling. The use or prohibition of motorized scooters is controlled by and subject to the facility's rules, regulations and guidelines.
- All lifts, scooters, pallet jacks, dollies and manpower must be provided by the official service provider.
- Scooters and carts may only be used by the individuals to whom the scooters and carts are issued. GES equipment is for use by GES employees only. Please do not take it for your use.

Work Zone



- Customer acknowledges that the show site and surrounding areas are active work zones. Customer, its agents, employees and representatives are present on the show floor at their own risk.

Thank you for your complete cooperation.

GES Payment Policy

All orders are governed by the GES Payment Policy and GES Terms & Conditions of Contract as specified in this Exhibitor Services Manual.

Forest Products Machinery & Equipment Exposition
Georgia World Congress Center
June 14 - 16, 2017

Payment for Services

GES requires payment in full at the time services are ordered. Further, GES requires that you provide a credit card authorization with your initial order. For your convenience, we will use this authorization to charge your account for services, which may include labor, material handling, or any applicable fuel or energy surcharges.

Discount Prices

To qualify for discount pricing, orders must be received with payment on or before the discount price deadline(s).

Method of Payment

GES accepts MasterCard, Visa, American Express, check and bank ACH/Wire transfer.

Purchase orders are not considered payment. All payments must be made in U.S. funds drawn on a U.S. Bank. Exhibitors will be charged a \$50.00 fee for returned NSF checks.

Third Party Billing

Each exhibiting firm is ultimately responsible for all charges incurred on its behalf. GES reserves the right to institute collection action against the exhibitor if the authorized third party does not pay. See Third Party Billing Request form.

Tax Exempt

If you are tax exempt in the state in which you will be exhibiting, you must provide a Sales Tax Exemption Certificate for that state. Please send the above information to the GES office for this show.

Taxes vary by location and will be added to your invoice if you do not submit your tax exempt certificate prior to the deadline.

Adjustments and Cancellations

No adjustments to invoices will be made after the close of the show.

Please refer to the individual forms for labor and furnishings for cancellation fees. All orders cancelled by the Exhibitor or due to the cancellation of an event or their non-participation may be subject to cancellation fees equal to 50% - 100% of the total order, based upon the status of move-in, work performed and/or GES set-up costs or expenses.

A minimum non-refundable deposit of \$25.00 will be applied towards the invoice, unless there is a cancellation of your order. Additionally, GES retains the right to implement/assess a fuel or energy surcharge on all services as necessary based upon market conditions.

051600379

040417

G-2p 031016

GES Terms and Conditions of Contract

All orders are governed by the GES Payment Policy and GES Terms & Conditions of Contract as specified in this Exhibitor Services Manual.

Forest Products Machinery & Equipment Exposition
Georgia World Congress Center
June 14 - 16, 2017

GES Terms & Conditions are subject to change at GES' sole discretion without notice to any parties.

I. Definitions

GES: Global Experience Specialists, Inc., is hereinafter referred to as GES and/or GES Logistics, and/or Trade Show Electrical (a/k/a TSE) and/or Trade Show Rigging (a/k/a TSR) and their employees; Agents: GES' agents, sub-contractors, carriers, and the agents of each; Customer: Exhibitor or other party requesting Services from GES; Goods: Exhibits, property, and commodities of any type for which GES is requested to perform Services; Carrier: Motor carrier, van line, air carrier, or air or surface freight forwarder; Shipper: Party who tenders Goods to Carrier for transportation; Cold Storage: Holding of Goods in a climate controlled area; Accessible Storage: Holding of Goods in an area from which Goods may be removed during shows; Services: Warehousing, transportation, drayage, un-supervised labor, supervised labor and/or related services; Show Site: The venue or place where an exposition or event takes place; Supervised Labor (OK To Proceed): Union labor that is provided to a Customer to install or dismantle a booth or exhibit space, and is supervised and/or directed by GES; Un-Supervised Labor (Do Not Proceed): Union labor that is provided to a Customer to install or dismantle a booth or exhibit space and pursuant to Customer's election is not supervised and/or directed by GES. Customer assumes the responsibility and any liability arising therefrom, for the work of union labor when Customer elects to use un-supervised labor.

II. Scope

These Terms and Conditions shall be binding upon Customer, GES, and their respective Agents and representatives, including but not limited to Customer contracted labor such as Customer Appointed Contractors and Installation and Dismantle Companies, and any other party with an interest in the Goods. Each shall have the benefit of and be bound by all provisions stated herein, including but not limited to time limits and limitations of liability.

III. Customer Obligations

- a. Payment for services. Customer shall be liable for all unpaid charges for services performed by GES or Agents. Customer authorizes GES to charge its credit card directly for services rendered on Customer's behalf after departure, by placing an order on-line, via fax, phone or through a work order on site.
- b. Credit Terms. All charges are due before Services are performed unless other arrangements have been made in advance. GES has the right to require prepayment or guarantee of the charges at the time of request for Services. A failure to pay timely will result in Customer having to pay in cash in advance for future services. GES retains its right to hold Customer Goods for non-payment. If a credit card is provided to GES, GES is authorized to bill to such credit card any unpaid charges for services provided to Customer, including charges for return shipping. Any charges not paid within 30 days of delivery will be subject to interest at 1 ½% per month until paid.

IV. Mutual Obligation Indemnification

- a. Customer to GES: Customer shall defend, hold harmless and indemnify GES from and against any claims, lawsuits, demands, liability, costs and expenses, including reasonable attorney's fees and court costs, resulting from any injury to or death of persons, or damage to property other than Goods, relating to or arising from performance of Services herein. Customer agrees to indemnify and hold GES harmless for any and all acts of its representatives and agents, including but not limited to Customer Appointed Contractors and Installation and Dismantle Companies, any subtenant or other user of its space or any agents or employees engaged in business on behalf of Customer or present at Customer's invitation, including supervision of labor secured through GES. Customer's obligations under this provision shall not apply to GES' own negligence and/or willful misconduct. Customer acknowledges that the show site is an active work zone and customer, its agents, employees and representatives are present at their own risk.
- b. GES to Customer: To the extent of GES' own negligence and/or willful misconduct, and subject to the limitations of liability below, GES shall defend, hold harmless and indemnify Customer from and against any claims, lawsuits, demands, liability, costs and expenses, including reasonable attorney's fees and court costs, resulting from any injury to or death of persons, or damage to property other than Goods. GES' obligations under this provision shall not apply to claims for bodily injury arising a) from Customer's presence in areas which have been marked as "off limits to exhibitors"; and b) when exhibitors are present in the facility prior or subsequent to the effective dates or hours of Exhibitor's space lease with show management.

V. Disclaimer and Limitation of Liability

Under no circumstances will any party be liable for special, incidental, consequential indirect or punitive damages, including but not limited to loss of profits or income. GES shall be liable, subject to the limitations contained herein, for loss or damage to goods only if such loss or damage is caused by the direct negligence or willful misconduct of GES. Claims presented for loss or damage arising out of incidents referenced in section VI herein will be denied.

040417 051600379

G-7 062116

VI. No Liability for Loss or Damage to Goods

- a. Condition of Goods: GES shall not be liable for damage, loss, or delay to uncrated freight, freight improperly packed, glass breakage or concealed damage. GES shall not be liable for ordinary wear and tear in handling of Goods or for damage to shrink wrapped Goods. All Goods shall be able to withstand handling by heavy equipment, including but not limited to forklifts, cranes, or dollies. It is the Customer's responsibility to ensure that Goods are packaged correctly prior to shipment or movement on or off the Show floor.
- b. Receipt of Goods: GES shall not be liable for Goods received without receipts, freight bills, or specified piece count on receipts or freight bills, or for bulk shipments (i.e., UPS, air freight, or van lines). Such Goods shall be delivered to booth without the guarantee of piece count or condition.
- c. Force Majeure: GES shall not be liable for loss or damage that results from Acts of God, weather conditions, act or default of Customer, shipper, or the owner of the Goods, inherent nature of the Goods, public enemy, public authority, labor disputes, and acts of terrorism or war.
- d. Cold Storage: Goods requiring cold storage are stored at Customer's own risk. GES assumes no liability or responsibility for Cold Storage.
- e. Accessible Storage: GES assumes no liability for loss or damage to Goods while in Accessible Storage. Storage charges are for the use of space and are not a form of insurance, or a guarantee of security.
- f. Unattended Goods: GES assumes no liability for loss or damage to unattended Goods received at Show Site at any time from the point of receipt of inbound Goods until the loading of the outbound Goods, including the entire term of the respective show or exhibition. Customer is responsible for insuring its own Goods for any and all risk of loss.
- g. Empty Storage: GES assumes no liability for loss or damage to Goods or crates, or the contents therein, while containers are in Empty Storage. It is Customer's sole responsibility to affix the appropriate labels available at the GES Service Desk for empty container storage, and ensures that any pre-existing empty labels are removed.
- h. Forced Freight: GES is not liable for Customer Goods left on the show floor after the show closing deadline, with or without a Material Handling Services/Straight Bill of Lading signed by Customer. It is Customer's responsibility to complete accurate paperwork for shipping and to ensure Customer Goods are properly labeled. If Customer Goods remain on the floor after the show closing deadline, GES has the right to remove the Customer Goods. GES is authorized by Customer to proceed in the manner chosen by Customer on the Order of Material Handling Services/Straight Bill of Lading, if one has been completed, or otherwise to ship Customer Goods at the discretion of GES and at Customer's expense. GES shall incur no liability for such shipment. GES retains the right to dispose of Customer Goods without liability if left on the show floor unattended, without labels or not correctly labeled.
- i. Concealed Damage: GES shall not be liable for concealed loss or damage including but not limited to; glass, electronic equipment, prototypes, original art, uncrated Goods, or improperly packaged or labeled Goods.
- j. Unattended Booth: GES shall not be liable for any loss or damage occurring while the Goods are unattended in Customer's booth at any time, including, but not limited to, the time the Goods are delivered to the dock until the time the Goods are received by Customer's chosen carrier. All Material Handling Forms and/or Straight Bills of Lading covering outgoing Goods submitted to GES will be checked at the time of pickup from the booth and corrections to the count or condition will be documented where discrepancies exist.
- k. Hanging items from Booth: Customer shall not hang any articles, merchandise, product, advertisements, or other similar items from GES supplied booth materials (this includes but is not limited to GES panels or pipe and drape), utilized in Customer's own booth set up or in areas occupied by the show organizer or third parties. If Customer does hang any prohibited items, Customer alone shall be held liable for any damages, costs, actions or injuries resulting from the hanging of such item(s). GES shall have no liability for any damages, costs, actions or injuries arising out of Customer's failure to comply with this provision.

VII. Measure of Damage

- a. Sole Relief: If found liable for any loss, GES' sole and exclusive maximum liability for loss or damage to Customer's Goods is limited to \$.50 (USD) per pound with a maximum liability of \$100.00 (USD) per container, or \$1,500.00 (USD) per shipment whichever is less.
- b. Labor: GES assumes no liability for loss, damage, or bodily injury arising out of Customer's supervision of GES provided union labor. If GES supervises labor for a fee, GES shall be liable only for actions or claims arising out of its negligent supervision. Such liability shall be limited to the cost to Customer of the supervised labor or the depreciated value of the Goods, whichever is less. If Customer elects to use unsupervised labor, then Customer assumes all liability for the actions or claims that arise out of such work, including but not limited to loss, damage or bodily injury and shall provide GES and show management with an indemnity, including defense costs, for any claims that result from Customers' supervision or failure to supervise assigned labor.

VIII. Miscellaneous

- a. Insurance: GES is not an insurance company and does not offer or provide insurance. It is the obligation of Customer to ensure Goods are insured at all times. Loss or theft of the Goods in storage or in transit to and from the show and or while on the show floor is the sole responsibility of Customer. GES recommends Customer arrange for all Risk Coverage.
- b. Notice of Loss or Damage: In order to have a valid claim, notice of loss or damage to Goods must be given to GES or its agent within 24 hours of occurrence (as evidenced in an Incident Report completed at Show Site by GES) or delivery of outbound Goods.
- c. Filing of Claim: Any claim for loss or damage to Goods must be in writing, containing facts sufficient to identify the Goods, asserting liability for alleged loss or damage, and making claim for the payment of a specified or determinable amount of money. Such claim must be filed with the appropriate party within the time limits specified herein. Damage reports, incident reports, inspection reports, notations of shortage or damage on freight bills or other documents, do not constitute filing of a claim.
- Claims for Goods alleged to be lost, stolen or damaged at the Show Site must be received in writing by GES within thirty (30) days after the close of the show. Claims for Goods alleged to be lost or damaged during transit must be received by the responsible party within nine (9) months of date of delivery of Goods. GES Logistics subcontracts the movement of Goods to third party carriers. Claims for damage in transit should be made directly with your carrier as shown on the Material Handling form/ Bill of Lading.
- In the event of a dispute with GES, Customer will not withhold payment or any amount due GES for Services as an offset against the amount of the alleged loss or damage. Customer agrees to pay GES prior to the close of the show for all such charges and further agrees that any claim Customer may have against GES shall be pursued independently by Customer as a separate action to be resolved on its own merits. GES retains the right to pursue collection on amounts owed after show close, without regard to any amount alleged to be owed for damage, or loss.
- d. Filing of Suit: Any action at law regarding loss or damage to Goods must be filed within one (1) year of the date of declination of any part of a claim (logistics claims excluded).

G-7 062116 040417 051600379

IX. Jurisdiction, Choice of Forum

These Terms and Conditions of Contract shall be governed by and construed in accordance with the applicable laws of the United States or, alternatively, and depending on jurisdiction, the laws of the State of Nevada. The parties hereby submit to jurisdiction and venue in the United States Federal District Court of Nevada, or as applicable depending upon jurisdiction, the County Circuit Court in Clark County, Nevada.

X. Advanced Warehousing/Temporary Storage/Long Term Storage

All terms and conditions relative to Advanced Warehousing/Temporary Storage/Long Term Storage are contained in separate agreements titled "Storage Agreement." In the event that a Storage Agreement is not executed between the parties, the following shall apply with respect to GES' liability for Customer Goods. The responsibility of GES with respect to Customer Goods is limited to the exercise of ordinary care and diligence in handling and storing of Customer Goods. GES shall be liable only for loss or damage to Goods caused by GES' sole negligence. GES' liability is limited to \$.60 (USD) per pound with a maximum liability of \$100.00 (USD) per container, or \$1,500.00 (USD) per shipment whichever is less. In case of partial loss or damage, the maximum liability shall be prorated based on weight. GES is not responsible for any loss or damage to Goods caused by, but not limited to fire, theft, the elements, vandalism, moisture, vermin, mechanical breakdown or failure, freezing or changes in temperature, as well as any other causes beyond GES' immediate control. GES is not responsible for the marring, scratching or breakage of glass or other fragile items. GES is not liable for the mechanical functions of instruments or appliances even if such articles are packed or unpacked by GES. In no event shall GES be liable for special, incidental, indirect or consequential damages, including business loss of any kind, resulting from any damage to or loss of the Goods or from any act or failure to act. Customer pays storage fees or costs for advance warehousing for use of the space only. There is no guarantee of security or representations made by GES as to appropriateness of the conditions for Customer Goods. The risk of loss remains Customer's alone and GES recommends the Customer carry and maintain insurance in amounts sufficient to cover its risk.

XI. Personal Data

Customer authorizes GES to use personal information ("PI") submitted to GES in connection with the Show as follows: (a) GES stores, processes and transmits credit card information only in compliance with Payment Card Industry Data Security Standards security requirements; (b) GES stores credit card information through its expiration date to better serve Customer's future event needs, unless Customer instructs GES to delete it earlier; (c) GES uses PI only as necessary to administer orders for the Show but otherwise does not disclose PI without either Customer's express authorization or a mandatory legal requirement; (d) GES retains PI of Customer's primary contacts (including name and email) on an ongoing basis to better serve Customer's future event needs until either GES' Privacy Policy requires or Customer instructs GES to delete it; and (e) GES securely stores PI including credit card information on servers located in the United States. GES protects PI with technical, organizational and other safeguards in conformity with applicable data protection laws including, without limitation, privacy laws of European Union countries. If Customer provides GES with PI of a European Union resident, then Customer warrants that it is authorized to do so for the above purposes and the parties agree to cooperate by executing further agreements as required by applicable law. Data subjects have the right to access, amend and oppose the use of their PI. GES may be contacted as provided in its Privacy Policy published at <http://www.ges.com/us/legal/privacy-policy>.

Index

All orders are governed by the GES Payment Policy and GES Terms & Conditions of Contract as specified in this Exhibitor Services Manual.

Forest Products Machinery & Equipment Exposition
Georgia World Congress Center
June 14 - 16, 2017

A

Advance Shipping Labels, Page 58

Agreement and Rules and Regulations
between GES and EAC, Page 83

B

Booth Layout - Hanging Signs, Page 79

C

Carpet Brochure, Page 12

Carpet Order Form, Page 13

Carpet Package Order Form, Page 14

Cartload Service Order Form, Page 65

Certificate of Liability Insurance Sample,
Page 85

Cleaning and Porter Service Order Form,
Page 81

Convenience Package Order Form, Page 36

Crane / Versa Lift Order Form, Page 71

D

Digital File Preparation, Page 47

Direct Shipping Labels, Page 59

Domestic Third Party Billing Request, Page
10

E

Exhibitor Appointed Contractors (EACs)
and Third Parties, Page 82

F

Forklift Order Form, Page 69

Freight Service Questionnaire, Page 61

Furniture & Accessories Order Form, Page
17

Furniture Package Order Form, Page 20

G

General Information, Page 6

GES Information and Order Forms, Page 3

GES Payment Policy, Page 89

GES Terms, Page 90

GES Terms and Conditions of Contract,
Page 90

GES Transportation Plus, Page 54

Graphics & Signage Order Form, Page 49

H

Hanging Sign / Truss Labor Information,
Page 74

Hanging Sign Labor Order Form, Page 75

Hanging Sign Shipping Labels, Page 80

I

International 3rd Party Billing Request,
Page 11

M

Marshaling Yard & Direct Deliveries
Information, Page 62

Material Handling/Drayage Information,
Page 51

Material Handling/Drayage Order Form,
Page 55

N

Notice of Intent to Use EAC and Policies
and Procedures, Page 82

051600379

040417

Index

All orders are governed by the GES Payment Policy and GES Terms & Conditions of Contract as specified in this Exhibitor Services Manual.

Forest Products Machinery & Equipment Exposition
Georgia World Congress Center

O

Operation of All Mechanical Lifts, Page 88

Vehicle Placement Order Form, Page 66

P

Payment and Credit Card Charge Authorization, Page 9

Pre-Printed Bill of Lading (BOL) / Outbound Labels Request, Page 60

R

Request for Variance to Assigned Target Time, Page 64

S

Shipping Labels: Advance, Page 58

Shipping Labels: Direct, Page 59

Show Information, Page 4

Show Site Work Rules, Page 86

Special Handling Brochure, Page 57

Specialty Furniture Brochure, Page 21

Specialty Furniture Order Form, Page 30

Standard Exhibit Systems Brochure, Page 38

Standard Exhibit Systems Order Form, Page 45

Standard Furniture Brochure, Page 15

Standard Graphics Brochure, Page 50

Stop. Think. Safety., Page 87

T

Targeted Move-in and Freight Information, Page 63

Tips for New Exhibitors, Page 7

V

051600379

040417